

DPL

DIGITAL PANEL INDICATOR
with linear inputs

INSTRUCTION MANUAL

170.MAN.DPL.E00 0,1.2 - 99 /C

CONTENTS

SECTION 1 GENERAL INFORMATION

1.1	INTRODUCTION	Page	1.1
1.2	PRODUCT SPECIFICATIONS		1.1
1.3	OPTIONS		1.4
1.4	CODING		1.5

SECTION 2 INSTALLATION

2.1	MOUNTING		2.1
2.2	WIRING GUIDE LINES		2.2

SECTION 3 INSTRUMENT CONFIGURATION

3.1	FRONT PANEL DESCRIPTION		3.1
3.2	INSTRUMENT CONFIGURATION		3.4

SECTION 4 OPERATING INSTRUCTIONS

4.1	PRELIMINARY		4.1
4.2	OPERATIVE MODE		4.1

SECTION 5 INSTRUMENT CALIBRATION PROCEDURE

5.1	DIP SWITCHES LOCATION		5.1
5.2	GENERAL GUIDE LINES FOR CALIBRATION		5.2
5.3	CALIBRATION PROCEDURE		5.2

SECTION 6 DEFAULT PARAMETERS SETTING

6.1	PRELIMINARY		6.1
6.2	DEFAULT PARAMETERS SETTING		6.1
6.3	DEFAULT CONFIGURATION PARAMETERS		6.1
6.4	DEFAULT CALIBRATION PARAMETERS		6.2
6.5	DEFAULT OPERATIVE PARAMETERS		6.2

SECTION 7 ERROR MESSAGES

7.1	OUT OF RANGE		7.1
7.2	OPEN INPUT CIRCUIT		7.1
7.3	ERRORS		7.1
7.4	ERROR DESCRIPTIONS		7.2

DIMENSIONS AND PANEL CUT-OUT

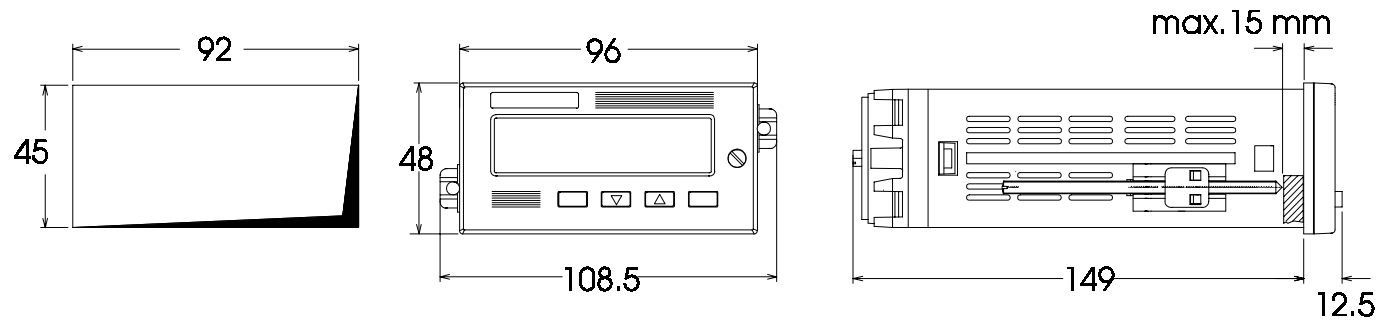

HORIZONTAL MOUNTING : Min distance between cut outs : 20 mm

PACKING OF MORE INSTRUMENT IN A SINGLE CUT OUT (max 10 instruments): The total dimension of the cut out is the addition of the front dimensions minus 3 mm. Vertical dimension of the cut out = $(n \times 48) - 3$ mm where n is the number of instruments to be packed.

SECTION 1 GENERAL INFORMATION

1.1 INTRODUCTION

The DPL is digital panel indicators for linear inputs developed with a variety of features.

As part of ERO ELECTRONIC background, this family also maintains a high standard in quality, reliability and man/machine interface simplicity.

The standard features like switching power supply, square root extraction on the input variable, programmable digital filter on the displayed value, max. value data hold, min. value data hold, two independent alarms with relay outputs and isolated auxiliary power supply offer the widest range of possible application.

The DPL comes with a complete availability of linear ranges (0-20 mA, 4-20 mA, 0-5 V, 1-5 V, 0-10 V and 2-10 V) with the capability to display it, in engineering units, on a 4 digit plus dummy zero display (99990) and it can be also supplied with RS 485 isolated serial communication interface or a galvanically isolated analog retransmission of the displayed value.

1.2 PRODUCT SPECIFICATIONS

1.2.1 GENERAL SPECIFICATIONS

Case :PC/ABS black color; self-extinguishing degree : V-0 according to UL 94 - VDE - CSA.

Front panel : IP 54 protection (IEC 529 and CEI 70-1).

Installation :panel mounting by means of tie rods.

Instrument removable from case by screwdriver help

Plug in construction : PC boards are assembled by snap in action for easy inspection and replacement of all boards.

Rear terminal block: with screw terminals and completed with identification labels, connection diagrams and safety rear cover.

Dimensions: 1/8 DIN (DIN 43700) 48 x 96 mm, depth 149 mm.

Cut-out : 45 x 92 mm +0,8 mm - 0,0 mm.

Weight : 600 g max.

Displays: 5 red LED digits, 13.2 mm high, 7 segments plus decimal point.

Front indicators: AL1- AL2- REM.

Power supply: 100V to 240V AC 50/60Hz (-15 % to + 10 % of the nominal value) or 24 V AC/D.C. (± 10 % of the nominal value)

Power consumption : 8 VA max.

Insulation resistance: > 100 M Ω according to IEC 348.

Dielectric strength: 1500 V in accordance with IEC 348.

Conversion: dual slope integration.

Resolution: 25000 counts

Sampling time: 100 ms typical.
Display updating time: 400 ms typical.
Accuracy: $\pm 0.1\%$ fsv ± 1 digit @ 25 °C ambient temperature.
Common mode rejection ratio: 120 dB @ 50/60 Hz.
Normal mode rejection ratio: 60 dB @ 50/60 Hz.
Noise immunity: according to IEC 801-4, level 3
Temperature drift: < 200 ppm/°C on fsv.
Ambient temperature: 0 to 50 °C.
Storage temperature : -20 to +70 °C
Humidity: 20 to 85% RH, non condensing.
Protections: 1) WATCH DOG circuit for automatic restart.
 2) DIP SWITCHES for protection against tampering of configuration and calibration parameters.

1.2.2 INPUTS

Input type: See table below.
Input capability: from -20 to 120 % of the selected input range.
Readout: keyboard programmable with 2 different ranges:
 with 1 digit resolution from 1 to 10000
 with 10 digits resolution from 10 to 99990.
Readout filter: First order digital filter on the readout value with configurable time constant of 0.4, 1, 2, 3, 4 or 5 seconds.
Square root extraction: programmable
Decimal point : programmable in any position.
Burn out: down scale for 4-20 mA, 1-5 V and 2-10 V.
 It is not detectable for the other ranges.

STANDARD RANGES TABLE

Input type	Input impedance	Accuracy
0 - 20 mA	3 Ω	0.1 % ± 1 digit @ 25°C
4 - 20 mA	3 Ω	
0 - 5 V	≥ 200 k Ω	
1 - 5 V	≥ 200 k Ω	
0 - 10 V	≥ 200 k Ω	
2 - 10 V	≥ 200 k Ω	

1.2.3 ALARMS

Number of alarms: two independent

Threshold: from 0 to 100 % of the readout span.

Hysteresis: programmable from 0.1 to 9.9 % of the readout span.

Type of alarm: High or low alarms programmable.

NOTE : The alarm becomes active at the alarm threshold value and will be reset at the alarm threshold value plus or minus the hysteresis value, according to the alarm type.

Reset: Automatic or Manual, programmable.

The manual reset of the alarms is possible by front pushbuttons or by external contact.

Alarm action: direct or reverse (fail/safe) programmable

Alarm outputs: two relays, SPST, NC or NO selectable by jumpers.

Contact rating: 2.0 A @ 30 V DC on resistive load or
0.6 A @ 110 V AC on resistive load or
0.5 A @ 250 V AC on resistive load or
0.3 A @ 110 V DC on inductive load.

Alarm masking: low alarms can be programmed for masking at instrument start-up.

Filter: it is possible to apply to the alarm function a digital filter with the same time constant as chosen for readout filter.

Alarms indication: AL1 and AL2 indicators lit for alarm ON status.

1.2.4 AUXILIARY POWER SUPPLY

Isolation: galvanically isolated from instrument input and output.

Voltage output: 24 V DC

Accuracy : $\pm 5 \%$

Max. power: 1.25 W

1.2.5 ADDITIONAL FUNCTIONS

Peaks detection : visualization of the max. and min. value measured by the instrument

Digital filter: it is possible to set a digital filter on the displayed value with a time constant of 0.4, 1, 2, 3, 4 or 5 s. This filter can be applied to the analog retransmission and alarms threshold also.

Logic input: one input driven by dry contact for manual reset of the alarms or HOLD function enable.

Safety lock: for protection of the alarms threshold values.

Internal jumper : for configuration and calibration parameter protection.

1.3 OPTIONS

1.3.1 COMMUNICATION INTERFACE

Type: RS-485 optoisolated.

Communication type: bi-directional.

Protocol: "Polling/Selecting"

Baud rate: from 150 baud to 19200 baud.

Format: 7 bits + parity bit
8 bits + parity bit
8 bits without parity bit

Parity: odd or even

Stop bit: one

1.3.2 ANALOG RETRANSMISSION

Isolated analog retransmission of the displayed value.

Scaling: programmable from 0 to 99990

Output type : 1) 0-20 mA and 4-20 mA, maximum load 500 Ω ,
optoisolated
2) 0-10 V and 2-10 V minimum load 5000 Ω ,
optoisolated

Selection: (between 0-20 mA, 4-20 mA, 0-10 V and 2-10 V) by internal jumper and frontal keyboard.

Resolution : max. 0.05 % of the output span.

Accuracy: 0.2 % of the output span (@ 25°C).

Temperature drift: < 100 ppm/°C.

Output noise: < 0.1 % fsv RMS.

Updating time : 100 ms.

Filter: it is possible to apply to the analog retransmitted value a digital filter with the same time constant as chosen for readout filter.

NOTE : The analog retransmission excludes the serial interface option.

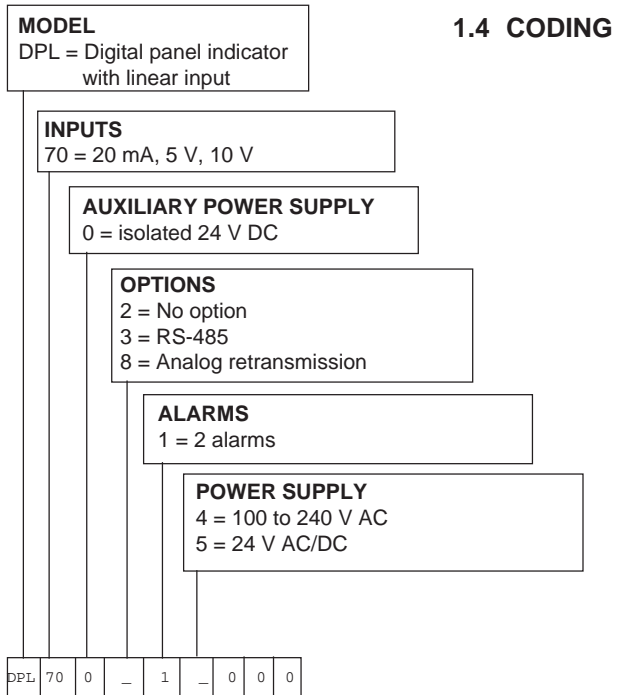

SECTION 2 INSTALLATION

2.1 MOUNTING

Select a mounting location where there is minimum vibration and the ambient temperature must be between 0 and 50 °C.

The instrument can be mounted on a panel up to 15 mm thick with a cut out of 45 x 92 mm $\begin{matrix} +0.8 \text{ mm} \\ 0 \text{ mm} \end{matrix}$

Remove the two mounting brackets from both sides of the instrument, and insert the instrument through the panel cut-out.

While holding the instrument against the panel, insert the mounting brackets and lock them by using a screwdriver until the instrument is held securely against the panel (see Fig. 2.1).

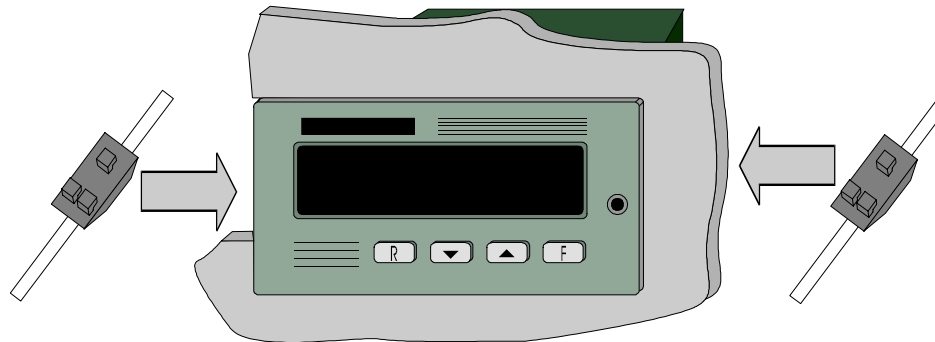

Fig. 2.1 HOW TO INSERT THE INSTRUMENT

2.2 WIRING GUIDE LINES

Connections are to be made with the instrument housing installed in its proper location.

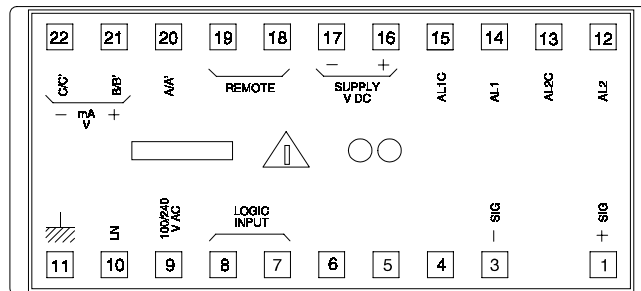

Fig. 2.2 REAR TERMINAL BLOCK

A) POWER LINE

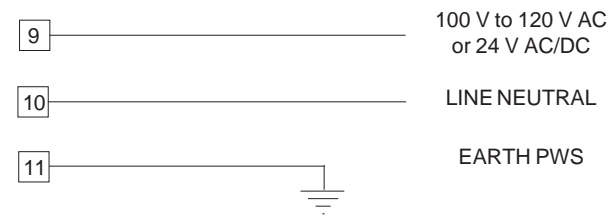
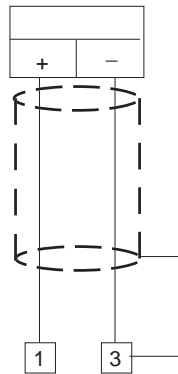

Fig. 2.3 POWER LINE WIRING

- NOTE: 1) Before connecting the instrument to the power supply, make sure that line voltage corresponds to lateral label indication.
 2) Terminal 11 must be connected to earth.
 3) To avoid electric shock, connect power supply at the end of the wiring procedure only.
 4) The power supply input has no fuse protection. Please, provide it externally.

B) INPUTS

2-wire transmitter without power supply



2-wire transmitter with power supply

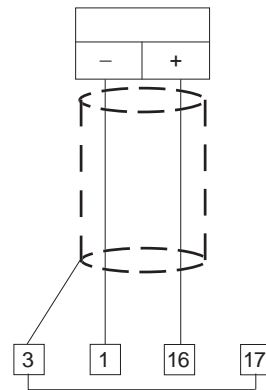

4-wire transmitter with power supply

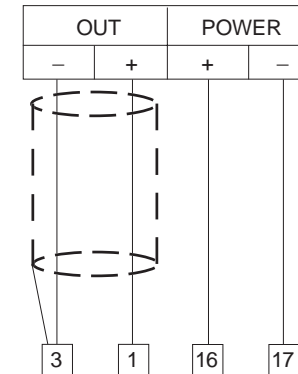

Fig 2.4 INPUT WIRING

NOTE: Don't run input wires together with power cables.

Use proper cable preferably shielded.

If shielded cable is used, the shield must be grounded at one point only.

When a voltage input is used, pay attention to the line resistance; a high line resistance may cause measurement errors.

C) EXTERNAL ALARM RESET OR HOLD FUNCTION

It is possible to reset both alarms of the instrument or hold the measured value by an external switch.

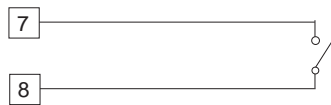

Fig. 2.5 - EXTERNAL ALARM RESET OR HOLD FUNCTION WIRING

D) LOCAL / REMOTE OPERATION

By this input it is possible to enable/disable the remote operative mode of the instrument.

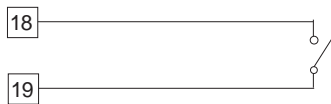

Fig. 2.6 LOCAL / REMOTE WIRING

E) OUTPUTS

E.1 ALARMS RELAY OUTPUT

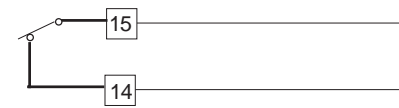

Fig. 2.7 ALARM 1 RELAY WIRING

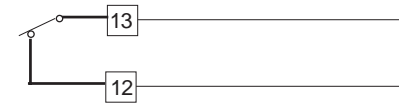

Fig. 2.8 ALARM 2 RELAY WIRING

The relay output is an SPST relay.

The contact ratings are: 2 A / 30 V DC on resistive load or
0.6 A / 110 V DC on resistive load or
0.5 A / 250 V AC on resistive load or
0.3 A / 110 V DC on inductive load.

The number of operations is 2×10^5 at specified rating.

E 1. INDUCTIVE LOADS

Switching inductive loads, high voltage transients may occur. These transients may damage the internal contacts, PCB or affect the performance of the instrument. In this case an external snubber network should be connected across the terminals as near as possible to the terminals (see Fig. 2.7 and 2.8).

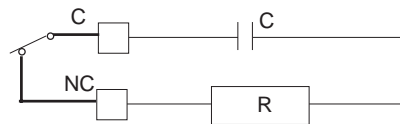

Fig. 2.9 EXTERNAL PROTECTION FOR INDUCTIVE LOAD GREATER THAN 40 mA AC

The value of capacitor (C) and resistor (R) are shown in the following table.

LOAD CURRENT	C (μF)	R (Ω)	RESISTOR POWER (W)	RESIST. AND CAPAC. VOLTAGE
< 40 mA	0.0022	100	1/2	260 VA.C.
< 150 mA	0.1	22	2	260 VA.C.
< 0.5 A	0.33	47	2	260 VA.C.

The same problem may occur when a switch is used in series with the internal contacts as shown in Fig. 2.10

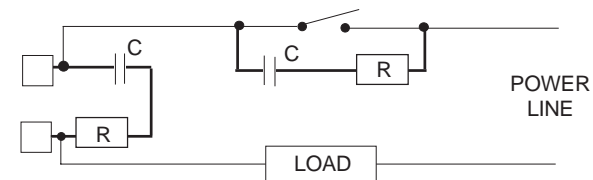

Fig. 2.10

In this case it should be better to protect the switch also as shown in Fig. 2.10. Anyway the cable involved in relay output wiring must be as far away as possible from input or communication cables.

E.1.2 EXTERNAL LOADS WITH VERY LOW HOLDING CURRENT

It may happen that the current flowing through the snubber network, when the contact is open, is sufficient to energize the external load (normally a contactor).

A similar problem may occur when driving solid state relay with the internal relay of the instrument.

The current flowing through the snubber network may keep the voltage across the SSR higher than the cutoff level.

In this case it is better to remove the snubber network.

E.2 ANALOG RE-TRANSMISSION

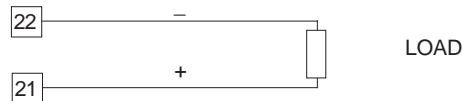

Fig. 2.11 ANALOG RE-TRANSMISSION WIRING

NOTES : 1) for mA output the maximum load impedance is 500 Ω .
2) For V output the minimum load impedance is 5000 Ω .

E.3 SERIAL INTERFACE

RS-485 interface allows to connect up to 31 instrument with the remote master unit. See Fig. 2.13.

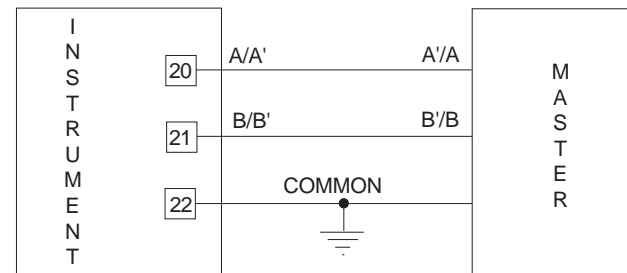

Fig. 2.12 - RS-485 WIRING

The cable length must not exceed 1.5 km at 9600 BAUD.

NOTE: The following report describes the signal sense of the voltage appearing across the interconnection cable as defined by EIA for RS-485.

- The "A" terminal of the generator shall be negative with respect to the "B" terminal for a binary 1 (MARK or OFF) state.
- The "A" terminal of the generator shall be positive with respect to the "B" terminal for a binary 0 (SPACE or ON)

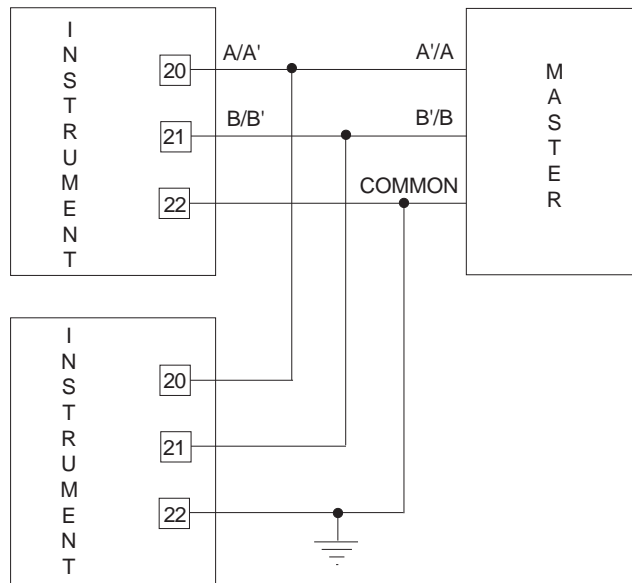

Fig. 2.13 - CONNECTION OF THE INSTRUMENTS (MAX 31) TO THE MASTER UNIT BY INTERFACE COMMUNICATION TYPE RS-485

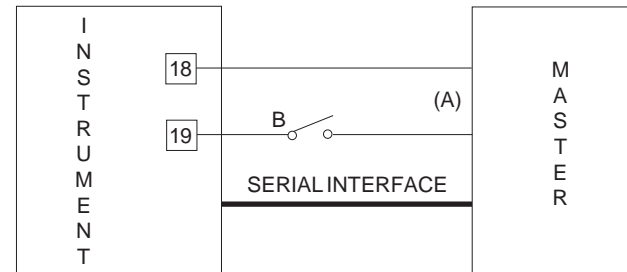
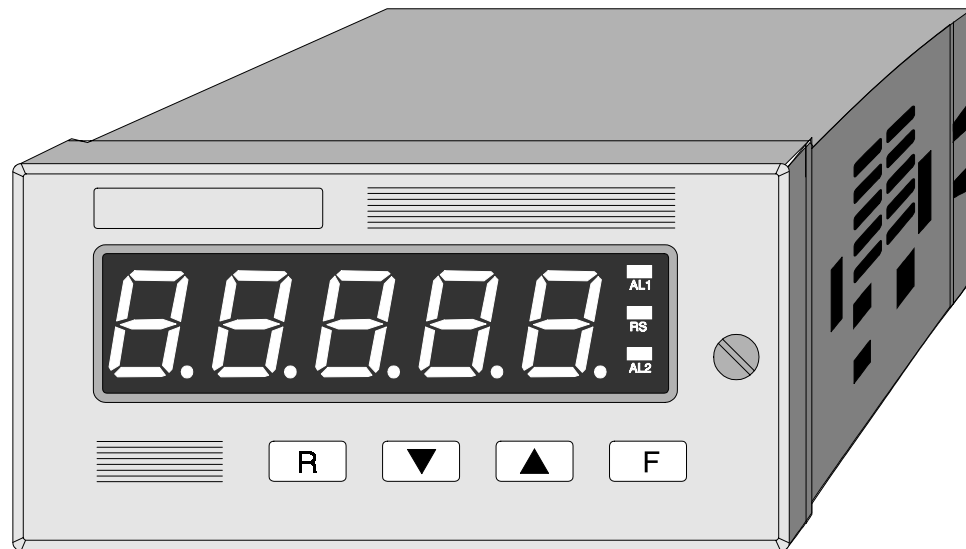

Fig. 2.14 - LOCAL/REMOTE CONTACT WIRING

A contact on the rear terminal block (terminals 18 and 19) is used to enable/disable the remote control.
 In case of emergency, the operator must regain control on the instrument by a switch (B) connected in series to the master control (A) and positioned near the instrument.
 The switch should have a minimum rating of 0.5 mA - 12 V DC.

SECTION 3 INSTRUMENT CONFIGURATION

3.1 FRONT PANEL DESCRIPTION



Page 3.1

3.1.1 INDICATORS

AL 1

Indicator OFF = no alarm condition

Indicator ON = alarm condition

AL 2

Indicator OFF = no alarm condition

Indicator ON = alarm condition

RS

Indicator OFF = setting by serial communication interface
disabled

indicator ON = setting by serial communication interface enabled

3.1.2 DISPLAYS

The display shows continuously the process variable in engineering units.

During configuration and calibration set up, this display is used to show the parameters name and the relative value.

3.1.3 KEYBOARD DESCRIPTION



To increase the parameter value or to select peak high and peak low visualization



To decrease the parameter value



To select all the parameters . Pushing the F pushbutton the parameters will be shown sequentially on the displays and, at the same time, the value of the previous parameter will be stored.



It is used to scroll back the parameters without to memorize the new values.



Alarm 1 and/or 2 manual reset



Alarm 1 and/or 2 manual reset



They are used to reset peak high and peak low and restart the peak detection procedure.



They are used to start the default parameters loading procedure.



Used to lock/unlock keyboard for parameter modification

3.2 INSTRUMENT CONFIGURATION

For configuration procedure, the internal jumper V2 , mounted on CPU card, must be positioned as follows:

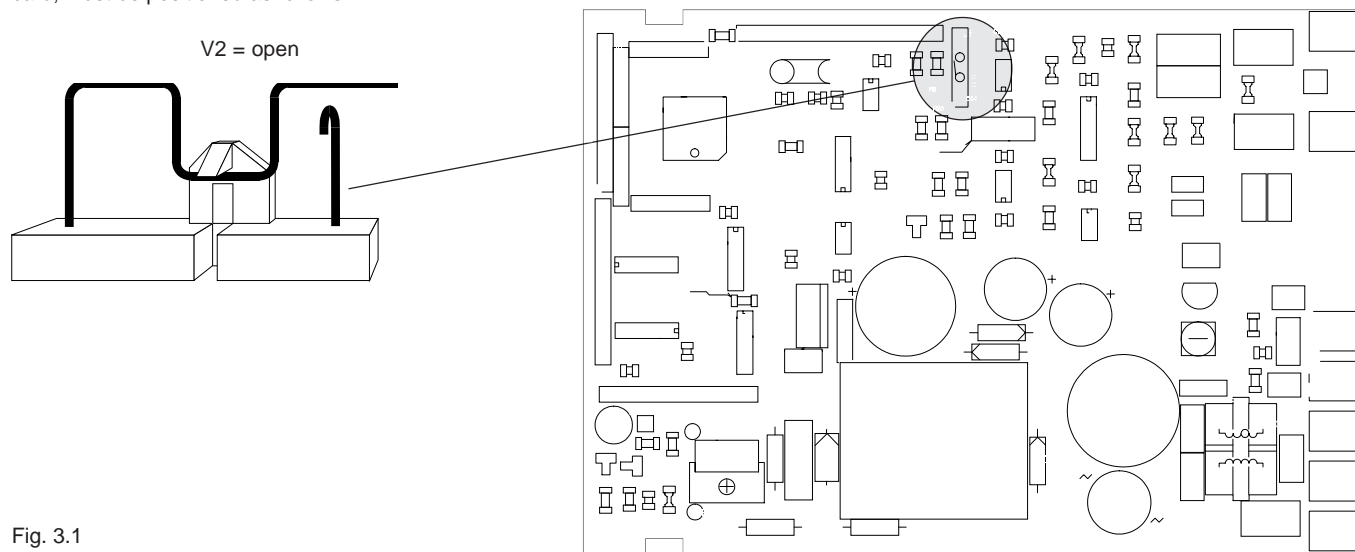

Fig. 3.1

3.2.1 PRELIMINARY HARDWARE SETTINGS

Before reassembling the instrument, make sure that all the necessary hardware settings are made as detailed below:

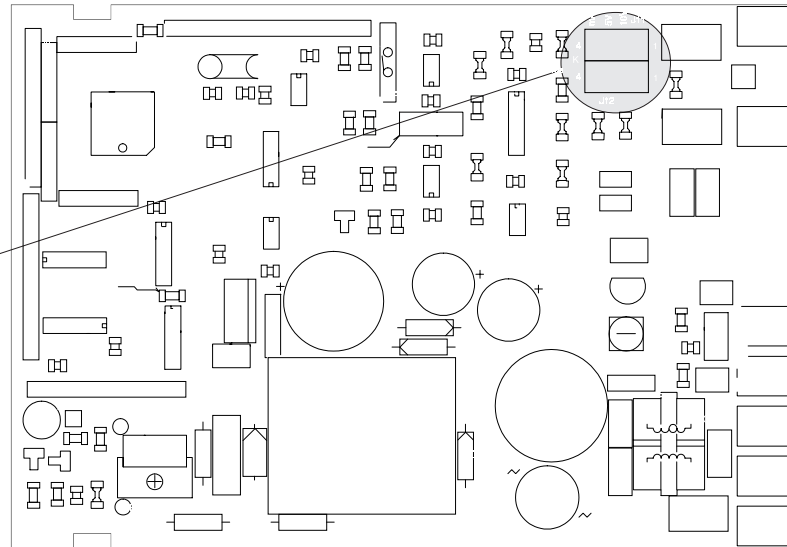

For input selection, the jumpers must be set as follows

For mA inputs	
For 5 V fs inputs	
For 10 V fs inputs	



Page 3.5

For alarms output, J250 and J251 must be set as follows:

Contact	NC	NO
AL 1	J250 = 1-2	J250 = 2-3
AL 2	J251 = 1-2	J251 = 2-3
Setting		

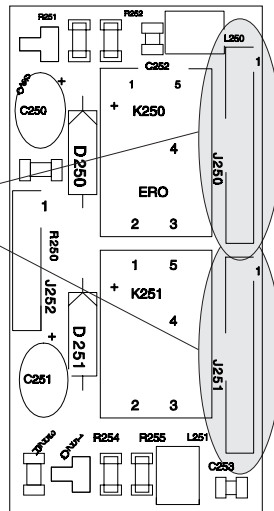

For analog retransmission, set the jumpers J104, J105 and J107 as follows:

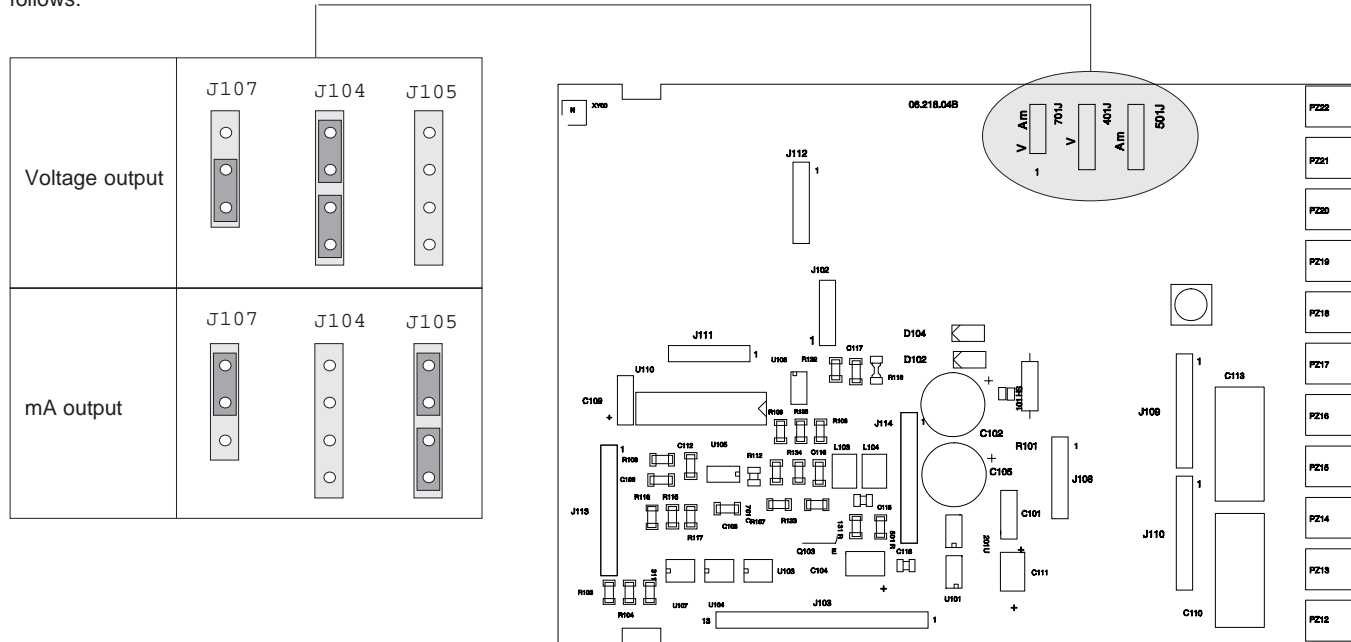

3.2.2 CONFIGURATION PROCEDURE

Once the internal jumper has been positioned as described in Fig. 3.1 proceed as follows:

1. The display will show "DPL" for 2 second, than it will show "CO_nF"
NOTE: at this point it is possible to start the default parameter loading procedure as detailed at section 6
2. Push F pushbutton. The instrument shows the first parameter code and the relative value.
3. To modify this value push ▲ or ▼ to obtain the desired setting.

When the display shows the new desired setting, push F pushbutton to store the value and go to the next parameter.

It is possible to go back in the parameter sequence by using R pushbutton but, after parameters modification, push the F pushbutton otherwise the new value will not be stored (the storage is made only when the F pushbutton is depressed).

3.2.3 PARAMETERS LIST

The following is the complete parameters sequence.
Some parameters may not be shown according to the previous parameters setting.

1) POWER SUPPLY FREQUENCY

The display will show :

L.F. 50 = 50 Hz

L.F. 60 = 60 Hz

NOTE: For D.C. power supply, it is suggested to select the same frequency of the local power line.

Push ▲ or ▼ pushbuttons to set the required frequency value.

Push the F pushbutton to memorize the new choice and go to the next parameter.

2) INPUT TYPE

The display will show "In" followed by:

0.20 = 0-20 mA

4.20 = 4-20 mA

0.5 = 0 - 5 V

1.5 = 1 - 5 V

0.10 = 0 - 10 V

2.10 = 2 - 10 V

Push ▲ or ▼ pushbuttons to set the desired range. Push the F pushbutton to memorize the new choice and go to the next parameter.

Input capability: from -20 to 120 % of the selected input range.

2.A) DECIMAL POINT POSITION

The display will show :

- . = no decimal figure
- . = one decimal figure
- . = two decimal figures
- . = three decimal figures
- . = four decimal figures

Push ▲ or ▼ pushbuttons to set the desired position.

Push the F pushbutton to memorize the new position and go to the next parameter.

2.B) FULL SCALE READOUT

The display will show alternately "F.S.V." and a number between 0 and 99990 .

This parameter establishes the display reading at the full input.

- NOTES :**
- 1) Setting a full scale readout ≤ 10000 units, the readout resolution will be 1 digit.
Setting a full scale readout ≥ 10000 units, the readout resolution will be 10 digit.
 - 2) Initial scale readout, alarm thresholds and analog retransmission rang will use the same resolution selected for full scale readout.

Push ▲ or ▼ pushbuttons to set the desired value (when the square root extraction is selected, this value must be positive).
Push the F pushbutton to memorize the new value and go to the next parameter.

2.C) INITIAL SCALE READOUT

The display will show alternately "L.S.V." and a number between 0 and 99990 .

This parameter establishes the display reading at the initial value of the input range.

- NOTES:**
- 1) the value of the initial scale readout must be lower than the full scale readout.
 - 2) the minimum readout span (Full scale - initial scale) must be greater than 10 counts, for readout without dummy zero, or 100 counts for readout with dummy zero.

Push ▲ or ▼ pushbuttons to set the desired value.

Push the F pushbutton to memorize the new value and go to the next parameter.

2.D) SQUARE ROOT EXTRACTION

The display will show :

- S.r. no = square root disabled
- S.r.YES = square root enabled

Push ▲ or ▼ pushbuttons to set the desired solution.

Push the F pushbutton to memorize the new choice and go to the next parameter.

2.E) DIGITAL FILTER ON READOUT VALUES

The display will show "Ftc" followed by the time constant (in seconds) of the filter.

Using ▲ and ▼ pushbutton it is possible to select the desired time constant.

The possible choices are 0.4, 1, 2, 3, 4 or 5 s.

Push the F pushbutton to memorize the new choice and go to the next parameter.

3) EXTERNAL CONTACT FUNCTION

This step allows to select the function enabled and disabled by the external contact.

The display will show:

"E.C. Ho" = external contact used for hold-on-value sampling.

"E.C. nr" = external contact used for the reset of the alarms.

Push ▲ or ▼ pushbuttons and set the desired function.

Push the F pushbutton to memorize the new choice and go to the next parameter.

3.A) CONTACT STATUS

With this parameter it is possible to define the external contact status for function enabling.

The display will show :

"C.S. CL" = enabled with closed contact.

"C.S. OP" = enabled with open contact.

Push ▲ or ▼ pushbuttons and set the desired status.

Push the F pushbutton to memorize the new status and go to the next parameter.

4) ALARM 1 OPERATIVE MODE

The display will show :

A1 HA = high alarm with automatic reset

A1 HL = high alarm with manual reset (Latched alarm)

A1 LA = Low alarm with automatic reset

A1 LL = Low alarm with manual reset (Latched alarm)

OFF = alarm 1 not used.

Push ▲ or ▼ pushbuttons and set the desired options.

Push the F pushbutton to memorize the new configuration and go to the next parameter.

4.A) ALARM 1 ACTION

This step is skipped if alarm 1 is OFF

The display will show:

A1 rEV = Relay is energized in no alarm condition

A1 dir = Relay is energized in alarm condition

Push ▲ or ▼ pushbuttons and set the desired options.

Push the F pushbutton to memorize the new configuration and go to the next parameter.

4.B) ALARM 1 MASKING OPTION

This step is skipped if alarm 1 is OFF or HIGH.

The display will show:

A1 dIS = masking option disabled

A1 Enb = masking option enabled

NOTE: this function mask low alarm conditions during start-up until the measured value first becomes greater than the alarm threshold plus hysteresis.

Push ▲ or ▼ pushbuttons and set the desired options.

Push the F pushbutton to memorize the new configuration and go to the next parameter.

4.C) ALARM 1 FILTER

This step is skipped if alarm 1 is OFF.

The display will show:

F1 OFF = the alarm threshold will be compared with the instantaneous measured value.

F1 xxx = the alarm threshold will be compared with a filtered measured value.

The time constant of the filter (show by the "xxx" field) will be equal to the time constant chosen in step 2.E

4.D) ALARM 1 HYSTERESIS

This step is skipped if alarm 1 is OFF.

The display will show "H1" followed by a value from 0.1 to 9.9 (in percent of the readout span).

5) ALARM 2

Follow the same procedure as in steps 4 to 4.D above.

6) SERIAL INTERFACE ADDRESS

The display will show "Adr" followed by a number.

Using ▲ and ▼ pushbutton it is possible to select the desired instrument address from 1 to 95.

The 0 value disables the serial communication interface and, pushing F pushbutton, the instrument will go to parameter 7.

Push the F pushbutton to memorize the new value and go to the next parameter.

6.A) BAUD RATE

The display will show "bd" followed by a number.

Using ▲ and ▼ pushbutton it is possible to select the desired instrument baud rate from 150 to 19200 baud.

The speed of 19200 baud will be shown in kbaud (19.2).

Push the F pushbutton to memorize the new value and go to the next parameter.

6.B) BYTE FORMAT

The display will show :

- bF 7E = 7 bit + even parity
- bF 7O = 7 bit + odd parity
- bF 8E = 8 bit + even parity
- bF 8O = 8 bit + odd parity
- bF 8 = 8 bit no parity

Using ▲ and ▼ pushbuttons it is possible to select the desired byte format.

Push the F pushbutton to memorize the new choice and go to the next parameter.

7) ANALOG RETRANSMISSION TYPE

The display will show "Ao" followed by:

0 - 20 = output 0 - 20 mA

4 - 20 = output 4 - 20 mA

0 - 10 = output 0 - 10 V

2 - 10 = output 2 - 10 V

OFF = analog retransmission disabled

NOTE: this parameter selection must match the input jumper setting in page 3.7.

Push ▲ or ▼ pushbuttons and set the desired output.

Push the F pushbutton to memorize the new set and go to the next parameter.

NOTE: if the analog retransmission is disabled (OFF), parameters 7.A, 7.B and 7.C will be skipped.

7.A) ANALOG RETRANSMISSION : LOW SCALE VALUE

The display will show alternately "Ar.L.S.V." and a number between 0 and 99990.

The decimal point is positioned as programmed at step 2.A.

Push ▲ or ▼ pushbuttons and set the desired value. Push the F pushbutton to memorize the new value and go to the next parameter.

- NOTE:** 1) The analog retransmission range is not limited by the selected readout range.
2) It is possible to retransmit a reverse range by setting a LSV value higher than FSV value.

7.B) ANALOG RETRANSMISSION: FULL SCALE VALUE

The display will show alternately "Ar. F.S.V." followed by a number between 0 and 9999.

Push ▲ or ▼ pushbuttons and set the desired value.

Push the F pushbutton to memorize the new value and go to the next parameter.

- NOTE:** 1) The analog retransmission range is not limited by the selected readout range.
2) It is possible to retransmit a reverse range by setting a LSV value higher than FSV value.

7.C) DIGITAL FILTER ON THE ANALOG RETRANSMISSION

The display will show :

- rF OFF = no filter is applied on the analog retransmission
rF xxx = a filter with the same time constant chosen in step 2.E is applied to the analog retransmission.

Using ▲ and ▼ pushbutton it is possible to select the same time constant selected for readout or the exclusion of the filter (OFF)
Push the F pushbutton to memorize the new value and go to the next parameter.

At this point the configuration procedure is complete and the display will return to show COnF.

SECTION 4 OPERATING INSTRUCTIONS

4.1 PRELIMINARY

After the configuration procedure, it is possible to make the DPL operative by setting the internal jumper mounted on CPU (see Fig. 3.1 at page 3.4) as follows:

V2 = Closed

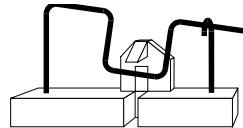

Now switch ON the instrument.

4.2 OPERATIVE MODE

The alarm setting-up procedures are checked by a time out of 10 s. approx. If during this time no other pushbutton has been pushed, the display will return to show the measured variable and the last change will not be stored.

NOTES: The R pushbutton is used to scroll back the parameters without memorization of the new values.
A wrong setting may be deleted by R pushbutton pressure.

The instrument can be operative in two different modes:

LOCAL : during this mode, it is possible to set the alarm threshold and to reset the alarms status by front keyboard.

REMOTE: during this operative mode, the alarms threshold setting and the manual reset of the alarms are possible only by serial link.

4.2.1 PEAK HOLD FUNCTION

Usually the display show the measured value in engineering units.

Pushing ▲ pushbutton it is possible to display the maximum peak value (peak high) measured by the instrument (the decimal point of the L.S.D. will be lit steady).

Pushing ▲ pushbutton again it is possible to display the minimum valley value (peak low) measured by the instrument (the decimal point of the L.S.D. will be flashing).

The memorization of the peak high and peak low values starts, automatically, when the instrument is switched on and it can not be stopped.

To clear the previous values proceed as follows:

- 1) set the instrument in LOCAL mode.
- 2) Push R + F pushbuttons contemporarily.

Note : The peak visualization does not disappear after time out.
Push ▲ pushbutton in order to display the measured value.

4.2.2 MANUAL RESET OF THE ALARMS

When one alarm has been configured as a latched alarm, the alarm indication persists also when the alarm condition disappears. When the instrument is in LOCAL mode, pushing R and ▲ pushbuttons (or R and ▼ pushbuttons) contemporarily it is possible to reset both alarms.

When the external alarm reset is programmed (see section 3) it will be ever possible to reset both alarms by an external contact.

The alarm reset action will be successful if the alarm condition has disappeared only.

4.2.3 KEYBOARD LOCK/UNLOCK

When the measured value is displayed (normal display mode), you can lock or unlock the keyboard by holding down the buttons in the following order: ▼ + R + F.

the display will show the new keyboard status

Loc = keyboard lock

UnLoc = keyboard unlock

4.2.4 ALARMS THRESHOLD SETTING

It is ever possible to display the alarms threshold while it is possible to modify the value only when the instrument is in LOCAL mode and the keyboard is in unlock condition.

The display will alternately show "1. x x x x" and the alarm 1 threshold where x x x x is the code of the alarm 1 operative mode.

2nd digit Alarm type	3rd digit Reset	4th digit Action	5th digit Masking
H = High L = Low	R = Automatic n = Manual	d = Direct r = reverse	n = masked blank= not masked

Push ▲ or ▼ pushbuttons and set the desired value.

Pushing the F pushbutton the new alarm 1 threshold will be stored and the display will alternately show "2. x x x x and alarm 2 threshold value.

Push ▲ or ▼ pushbuttons and set the desired value.

Pushing the F pushbutton the new alarm 2 threshold will be stored and the instrument returns to normal operation.

- NOTE:** 1) The alarm threshold modification is limited by minimum and maximum readout
2) Resolution and decimal point as selected for readout range.

4.2.5 HOLD FUNCTION

The HOLD function allows to stop data acquisition and hold the displayed value.

When the hold function is enabled, the measured value on the display is flashing.

Both alarms continue to operate according to the stopped displayed value.

The analog and digital retransmissions continue to retransmit the displayed value.

This function is operative also when the instrument is in remote mode and it is enabled/disabled by external contact (see paragraph 3.2.3. step 3).

SECTION 5 INSTRUMENT CALIBRATION PROCEDURES

5.1 DIP SWITCHES LOCATION

To start with the calibration procedure, the internal jumper V2, mounted on CPU card, must be open:

NOTE: during calibration procedure the serial communication interface will be disabled.

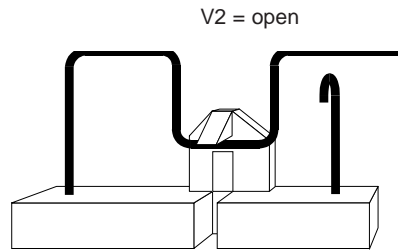
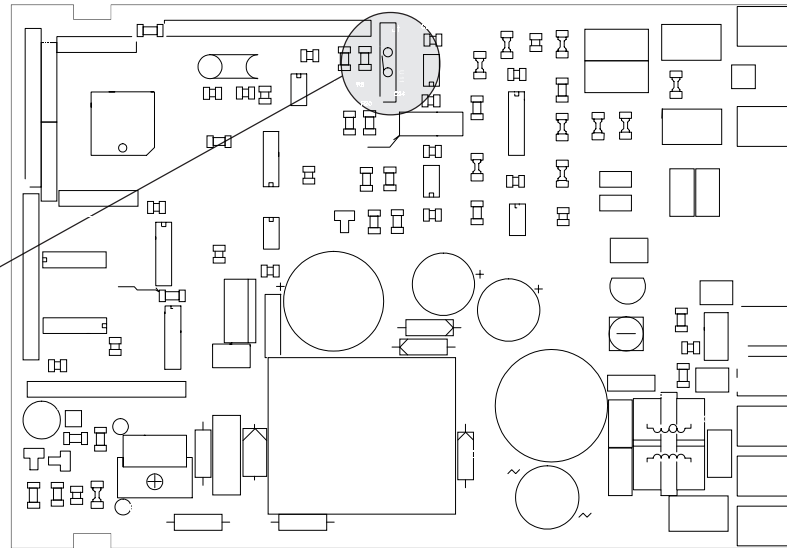

Fig. 5.1



Page 5.1

5.2 GENERAL GUIDE LINES FOR CALIBRATION

For a good calibration it is necessary to proceed as follows:

- a) - The instrument under calibration should be mounted in its case in order to keep the internal temperature constant.
- b) - The ambient temperature should be stable.
Avoid any drift due to air-conditioning or others.
- c) - The relative humidity should not exceed 70%.
- d) - Minimum warm-up time must be 20 minutes.
- e) - Operate possibly in a noise free environment.
- f) - During calibration, connect one input at a time and supply the input signal when the group is enabled only.

For this calibration procedure it is necessary to use calibrators with the following accuracy and resolution:

ACCURACY

- 1) For current input: $\pm 0.025\%$ output $\pm 0.0025\%$ range ± 0.01 mA
- 2) For V input: $\pm 0.005\%$ output $\pm 0.001\%$ range ± 5 mV

RESOLUTION

- 1) For current input: 0.2 mA
- 2) For V input : 100 mV

5.3 CALIBRATION PROCEDURE

5.3.1 FOREWORD

NOTE: Calibration parameters are logically divided in groups of two parameters each (initial and final scale value).

When only calibration check is required, press the F pushbutton when "OFF" is shown on the display. The instrument goes directly to the specific group check.

At instrument switching on, the display will show "CO n F".

Push \blacktriangle pushbutton; the instrument will show "CAL".

Push the F pushbutton to start calibration procedure.

From this point the display will show the parameter codes (C -) followed by "ON" or "OFF".

Using \blacktriangle and \blacktriangledown pushbuttons it is possible to select between "ON" or "OFF".

To go to the next parameter without modify the calibration, push F pushbutton when the display is showing "OFF" .

To start a new parameter calibration, push F pushbutton when the display show "ON".

NOTE: Pushing R pushbutton it is possible to go back to the previous parameter without modify the calibration.

VERY IMPORTANT

Before to made an input calibration, it is necessary to be sure that all the necessary hardware settings are made as detailed below:

For mA inputs	
For 5 V fs inputs	
For 10 V fs inputs	

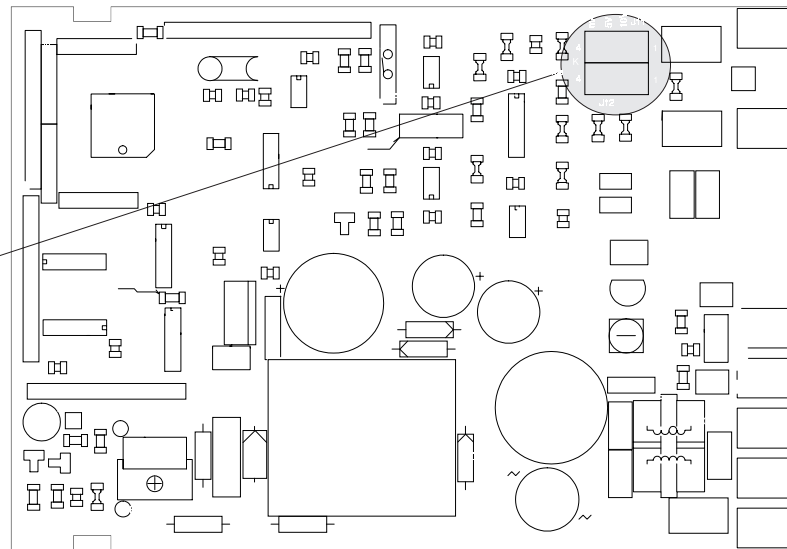

5.3.2 CALIBRATION PROCEDURE

All the instruments are factory calibrated by means of calibrators with high accuracy and resolution (see para. 5.2).

When the display shows "CAL" it is possible to load the default parameter as detailed in section 6

Follows a list of calibration symbols:

Code	Parameter
C 0	- Current input minimum range value (0 mA)
C 1	- Current input maximum range value (20 mA)
C 2	- Voltage input minimum range value (0 V)
C 3	- Voltage input maximum range value (5 V)
C 4	- Voltage input minimum range value (0 V)
C 5	- Voltage input maximum range value (10 V)
C 6	- Analog retransmission minimum range value (50 mA)
C 7	- Analog retransmission maximum range value (20 mA)
C 8	- Analog retransmission minimum range value (0 V)
C 9	- Analog retransmission maximum range value (10 V)

NOTE: apply only appropriate input signal when calibration or checking code are displayed.

C 0 - CURRENT INPUT MINIMUM RANGE VALUE

- Connect the instrument to the calibrator as shown in Fig. 5.2.
- Set 0.000 mA DC on the calibrator (even if the minimum range value is 4 mA).
The display will show "C0 OFF".
Depress ▲ pushbutton to enable the calibration; then the display will switch to "C0 On".
- Wait few seconds, until the measurement has stabilized.
- Push the F pushbutton; the displays will blank and only the decimal points will be lit. When the calibration is completed the instrument will go automatically to the next parameter.

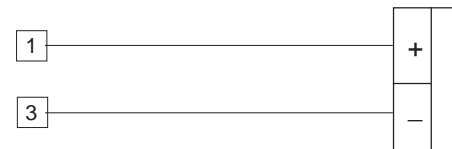

Fig. 5.2

C 1 - CURRENT INPUT MAXIMUM RANGE VALUE.

- a) Set 20,000 mA on the calibrator (see Fig. 5.2).
- b) Push ▲ pushbutton, the display will show "C1 On".
- c) Wait few seconds then push F pushbutton.
- d) Push the F pushbutton; the displays will blank and only the decimal points will be lit. When the calibration is completed the instrument will go automatically to the next step.

CURRENT INPUT CHECK

- a) The instrument will show a number showing the measured value in counts.
Set 20.000 mA on the calibrator, if C 1 calibration is correct the indication will be "25000" \pm 10 counts.
- b) Check the zero calibration by resetting the calibrator to 0.000 mA.
The resulting indication should give "00000" \pm 10 counts.
Check the linearity by setting the calibrator to 10.000 mA; the readout must be "12500" \pm 10 counts.
- c) Push F for the next calibration parameter.

C 2 - 0 - 5 V INPUT MINIMUM RANGE VALUE

- a) Connect the instrument to the calibrator as shown in Fig. 5.3.
- b) Set 0.000 V DC on the calibrator (even if the minimum range value is 1 V).
The display will show "C2 OFF".
Depress ▲ pushbutton to enable the calibration; then the display will switch to "C2 On".
- c) Wait few seconds, until the measurement has stabilized.
- d) Push the F pushbutton; the displays will blank and only the decimal points will be lit. When the calibration is completed the instrument will go automatically to the next parameter.



Fig. 5.3

C 3 - 0 - 5 V INPUT MAXIMUM RANGE VALUE.

- a) Set 5,000 V on the calibrator (see Fig. 5.3).
- b) Push ▲ pushbutton, the display will show "C3 On".
- c) Wait few seconds then push F pushbutton.
- d) Push the F pushbutton; the displays will blank and only the decimal points will be lit. When the calibration is completed the instrument will go automatically to the next step.

0 - 5 V INPUT CHECK

- a) The instrument will show a number showing the measured value in counts.
Set 5.000 V on the calibrator, if calibration is correct the indication will be "25000" \pm 10 counts.
- b) Check the zero calibration by resetting the calibrator to 0.000 V.
The resulting indication should give "00000" \pm 10 counts.
Check the linearity by setting the calibrator to 2.500 V; the readout must be "12500" \pm 10 counts.
- c) Push F for the next calibration

C 4 - 0 - 10 V INPUT MINIMUM RANGE VALUE

- a) Connect the instrument to the calibrator as shown in Fig. 5.4.
- b) Set 0.000 V DC on the calibrator (even if the minimum range value is 2 V).
The display will show "C4 OFF".
Depress ▲ pushbutton to enable the calibration; then the display will switch to "C4 On".
- c) Wait few seconds, until the measurement has stabilized.
- d) Push the F pushbutton; the displays will blank and only the decimal points will be lit. When the calibration is completed the instrument will go automatically to the next parameter.

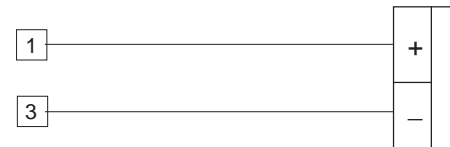

Fig. 5.4

C 5 - 0 - 10 V INPUT MAXIMUM RANGE VALUE.

- Set 10,000 V on the calibrator (see Fig. 5.4).
- Push ▲ pushbutton, the display will show "C5 ON".
- Wait few seconds then push F pushbutton.
- Push the F pushbutton; the displays will blank and only the decimal points will be lit. When the calibration is completed the instrument will go automatically to the next step.

0 - 5 V INPUT CHECK

- The instrument will show a number showing the measured value in counts.
Set 10.000 V on the calibrator, if calibration is correct the indication will be "25000" ± 10 counts.
- Check the zero calibration by resetting the calibrator to 0.000 V.
The resulting indication should give "00000" ± 10 counts.
Check the linearity by setting the calibrator to 5.000 V; the readout must be "12500" ± 10 counts.
- Push F for the next calibration parameter

C 6 - mA ANALOG RETRANSMISSION MINIMUM RANGE VALUE

NOTE : During calibration procedure the instrument will show C6, C7, C8 and C9 parameters only if analog retransmission is selected.

- Connect the instrument as shown in Fig. 5.5.
- Set J104, J105 and J107 on the option card as shown in fig. 5.6
- The display shows "C 6" and a number of counts.
- Using ▲ or ▼ pushbuttons, adjust the instrument output until 0.050 mA ± 0.005 mA is shown by the measuring device.
- Depress F pushbutton. The instrument memorizes the above value as zero.
The display will show now "C7" which means that the instrument is ready for next calibration step.

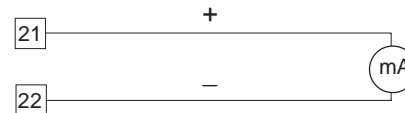

Fig. 5.5

NOTE: The minimum value must be calibrated at 50 mA even if the output is 4 - 20 mA.

Jumpers J104, J105 and J107 setting

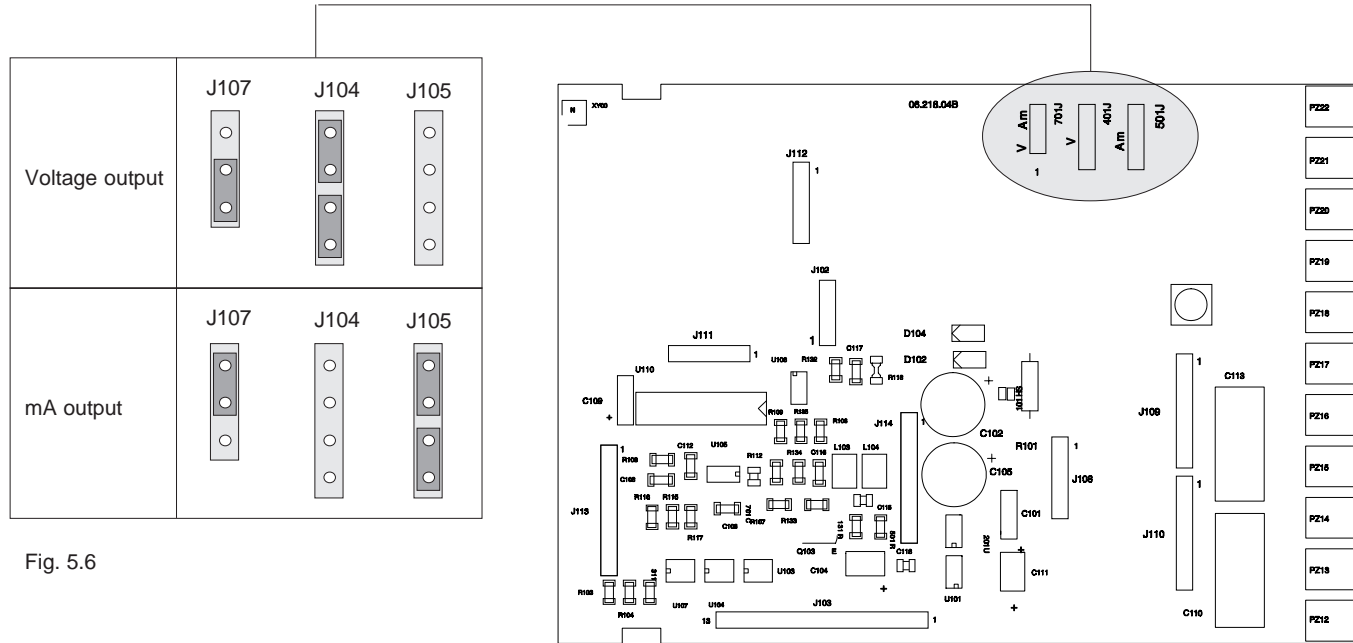

Fig. 5.6

**C 7 - mA ANALOG RETRANSMISSION
MAXIMUM RANGE VALUE**

- a) Push ▲ and ▼ pushbuttons until the output of the instrument is $20.000 \text{ mA} \pm 0.005 \text{ mA}$.
- b) Memorize this calibration by pushing F pushbutton.

**C 8 - 10 V ANALOG RETRANSMISSION
MINIMUM RANGE VALUE**

- a) Connect the instrument as shown in Fig. 5.7.
- b) Set J104, J105 and J107 on the option card as shown in fig. 5.6
- b) The display shows "C 8" and a number of counts.
- c) Using ▲ or ▼ pushbuttons, adjust the instrument output until $00.00\text{V} \pm 0.0025 \text{ V}$ is shown by the measuring device.
- d) Depress F pushbutton. The instrument memorizes the above value as zero.

The display will show now "C9" which means that the instrument is ready for next calibration step.

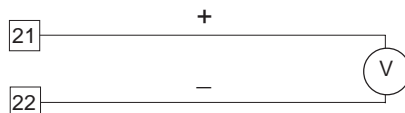

Fig. 5.7

NOTE: The minimum value must be calibrated at 0 V even if the output is 2 - 10 V.

**C 9 - V ANALOG RETRANSMISSION
MAXIMUM RANGE VALUE**

- a) Push ▲ and ▼ pushbuttons until the output of the instrument is $10 \text{ V} \pm 0.0025 \text{ V}$.
- b) Memorize this calibration by pushing F pushbutton.

With this last operation the instrument returns at the beginning of the calibration routine.
Switch off the instrument and set the dip switch V2 according to para. 4.1.

SECTION 6 DEFAULT PARAMETERS SETTING

6.1 PRELIMINARY

The instrument is delivered with a default parameters sets stored and usable, in every moment, for clear all the memories. Different parameters sets are provided for configuration, calibration and operative modes but the memorization follows the same procedure. During every particular working mode it is possible to load only the parameters of the specific mode.

6.2 DEFAULT PARAMETERS SETTING

Push ▼ pushbutton and, maintaining the pressure, push ▲ pushbutton.
The display will show "dFOFF".
Pushing ▲ pushbutton, on the display will appear "dF On".
Push F pushbutton to start default parameters loading.
During this routine the display will show "L.dAtA".
After loading routine the instrument will return to the initial status.

6.3 DEFAULT CONFIGURATION PARAMETERS

1	Power supply frequency	50 Hz
2	Input type	4-20 mA
2.A	Decimal point position	nO
2.B	Full scale readout	10000
2.C	initial scale readout	0
2.D	Square root extraction	nO
2.E	Readout digital filter	0.4 s
3	External contact function	Alarm manual reset
3.A	Contact status	Closed
4	Alarm 1 operative mode	High with automatic reset
4.A	Alarm 1 action	Reverse
4.B	Alarm 1 masking option	disable
4.C	Alarm 1 filter	Off
4.D	Alarm 1 hysteresis	0.1 %
5	Alarm 2 operative mode	High with automatic reset
5.A	Alarm 2 action	Reverse
5.B	Alarm 2 masking option	disable
5.C	Alarm 2 filter	Off
5.D	Alarm 2 hysteresis	0.1 %

Page 6.1

6	Serial interface address	00 (disable)
6.A	Baud rate	19200
6.B	Byte format	7 bits + even parity
7	Analog retransmission type	OFF (disable)
7.A	Retransmission minimum scale value	0
7.B	Retransmission maximum scale value	10000
7.C	Digital filter on the analog retransmission	Off

6.5 DEFAULT OPERATIVE PARAMETERS

Alarm 1 threshold	40 % of the readout span
Alarm 2 threshold	60 % of the readout span
Keyboard status	Unlock

6.4 DEFAULT CALIBRATION PARAMETERS

The default calibration parameters allow to verify the correct working of the instrument but they are not calibration parameters.

NOTE: After default calibration parameters loading, it is necessary to recalibrate the instrument.

SECTION 7 ERROR MESSAGES

7.1 OUT OF RANGE

The instrument shows the UNDER RANGE and the OVER RANGE with the following messages on the numerical display:



OVER RANGE



UNDER RANGE

During out of range indications, alarm status, peak detection and analog retransmission operate as in presence of the range limits.

NOTE: The out of range indication is shown when the input signal is 2% higher or 2% lower of the max. and min. scale values respectively.

To eliminate the OUT OF RANGE condition, proceed as follows:

- 1) Check the input signal source and the connecting line.
- 2) Make sure that the input signal is in accordance with instrument configuration. Otherwise, modify the input configuration (see chapter 3.2).
- 3) Send back the instrument to your supplier for a check.

7.2 OPEN INPUT CIRCUIT

This instrument is able to identify the open circuit for 4-20 mA, 1-5 V, 2-10 V inputs.

The open input circuit condition is shown by "OPEn" on the display. The instrument associates this status to under range condition.

NOTE: the open input circuit condition is shown when the input signal is lower than the minimum range value minus 4 % of the input span.

7.3 ERRORS

Diagnostics are made at instrument switch-on and during normal mode of operation.

If a fault condition (error) is detected, the display will show the message "Er" followed by the relative error code.

The following is a list of possible errors in numerical order.

Also causes, instrument output conditions and possible remedies are briefly described.

Same errors reset the instrument; if the error persist, send back the instrument to your supplier

7.4 ERROR DESCRIPTIONS

Er 1

The alarm threshold value are incompatible with the actual readout range or their values in memory are incorrect.
It may appear at instrument switching on in operative mode.
The instrument does not start to operate.
Push contemporarily ▲ and ▼ pushbutton and force the threshold values at the default value.
Set the desired threshold values.

Er 38

EAROM memory reading error.
It may appear at instrument switching on in operative mode.
The instrument does not start to operate.
The instrument remakes this check every 2 seconds.
If this error persists, send back the instrument to your supplier.

Er 39

EAROM memory writing error.
If this error appears during operative mode, it will be deleted automatically after 10 seconds.
The new values will be enabled but they will be lost at instrument switch-off.
If this error appears during configuration/calibration procedure, push F or R pushbutton to restart procedure.
If the error persists, send back the instrument to your supplier.

Er 101

Incorrect configuration data in EAROM memory.
It may appear at instrument switching on in operative mode.
The instrument does not start to operate.
It remakes this check every 2 seconds.
If this error persists, remake the configuration procedure.

Er 201

Incorrect calibration data in EAROM memory.
It may appear at instrument switching on in operative mode.
The instrument does not start to operate.
It remakes this check every 2 seconds.
If this error persists, remake the calibration procedure.

Er 216

Out of range during calibration.

The instrument detects an out of range signal or an open circuit condition during input calibration.

The instrument shows the error message for 6 seconds then it will return to the calibration point where the error was found.

The new calibration of this parameter will be lost, verify the input signal and redo the calibration procedure correctly.

Er 312

Autozero errors.

The instrument measures an internal autozero value too negative or too positive.

It may appear during the operative mode.

The instrument will not operate and will repeat this check 3 seconds.

If this error persists, send back the instrument to your supplier.

Er 313

The input calibration span is too great ($> 22 \text{ mA}$ or $> 5.5 \text{ V}$ or $> 11 \text{ V}$) or too small ($< 0.6 \text{ mA}$ or $< 150 \text{ mV}$ or $< 300 \text{ mV}$).

If this error appears during operative mode, the instrument will not operate and will repeat this check 3 seconds.

If this error appears during calibration check, the instrument needs a new calibration

Remake the calibration procedure.

If this error persists, send back the instrument to your supplier.

Er 402

This error may appear switch-on the instrument only.

The calibration and configuration parameters are not protected.

Go to configuration mode, select a parameter and push F pushbutton.

Return in operative mode.

If this error persists, send back the instrument to your supplier.







Ero Electronic s.r.l.

Via Nino Bixio, 47/49
20026 Novate Milanese (Milano)
Italy

Tel. (+39) 02354781
Fax. (+39) 023546625

A Siebe Group Company

Factories

ITALY

ERO ELECTRONIC S.r.l.
Via E. Mattei, 21
28100 Novara

MALTA

ERO ELECTRONIC (Malta) Limited
Tübingen Centre
F17, Mosta Technopark
Mosta MST 02

Branch Offices

BENELUX

ERO ELECTRONIC BENELUX S.A./N.V.
Rue du Val-Notre-Dame, 384
4520 MOHA (Wanze)
Tel.: 085-274080
Fax: 085-274081

BRAZIL

ERO ELECTRONIC DO BRASIL
Industria e Comercio Ltda
Rua Garibaldi, 659 - Conj. 202
90035-050 Porto Alegre - RS - Brasil
Tel.: 051-2214888
Fax.: 051-2214734

FRANCE

ERO ELECTRONIC Sarl
ZAC du Chêne
34, rue du 35ème Régiment d'Aviation
69673 BRON Cedex
Tel.: 0478267979
Fax: 0478267800

GERMANY

ERO ELECTRONIC GmbH
Ottostrasse 1
D-65549 Limburg
Tel.: 06431-95680
Fax: 06431-57493

SOUTH AFRICA

ERO ELECTRONIC S.A.
P.O. Box 43112
2042 INDUSTRIAL
Tel.: 011-4742278
Fax: 011-4749404

SWITZERLAND

ERO ELECTRONIC AG
Kempitalstrasse 27/A
8320 FEHRALTORF
Tel.: 01-9542220
Fax: 01-9543284

Representatives

CHINA

TIANJIN VEGA COMPANY Ltd
95 Zhi Cheng Road
Hebei District
300232 Tianjin PRC
Tel.: 022-26273296
Fax.: 022-26273297

UNITED KINGDOM / EIRE

EUKERO CONTROLS LTD
Unit 1 Waterside Business Centre
Railhead Road - Isleworth
Middlesex TW7 7BY
Tel.: 0181-5684664
Fax: 0181-5684115

U.S.A.

AMERICAN ERO ELECTRONIC CORP.
365 Bateman Circle
P.O. Box 3608
BARRINGTON ILL. 60010
Tel: 847-382-0881
Fax: 847-382-0240