

Digital Cam Switch Unit

CamCon DC300

for Siemens S7 300 PLC



Digitronic Automationsanlagen GmbH

Steinbeisstraße 3 · D - 72636 Frickenhausen · Tel. (+49)7022/40590-0 · Fax -10
Auf der Langwies 1 · D - 65510 Hünstetten-Wallbach · Tel. (+49)6126/9453-0 · Fax -42
Internet: <http://www.digitronic.com> · E-Mail: mail@digitronic.com

For your attention

This instruction manual relates to the CamCon DC300 from 10/2003 and the S7 DC300 software version 1.20. The CamCon DC300 run on all S7 300 CPU (not S7-318 with extended I/O range) and IM153 device state 6/2002. Note the restrictions with F-devices and the IM153 device. The company Digitronic Automationsanlagen GmbH reserves the right to make changes which present an improvement of the quality or functionality of the device without prior notice. The instruction manual was created with great care, although it may not be error-proof. We would be grateful for any communication relating to any errors you may have found.

UP-date

You can also obtain this instruction manual on the Internet at <http://www.digitronic.com> in the latest version as PDF file.

Qualified personnel

This device may only be started and operated by qualified staff. By qualified we mean personnel who are entitled to handle, to earth and to lable devices, systems and power circuits in accordance with the technology safety standards.

Liability

(1) The supplier is liable for damages caused by himself or by the owner of the rights up to the sum of the sales price. He is not liable for loss of profits, forfeited savings, intermediate and successive damages.

(2) The above mentioned limits to liability do not apply to insurance of named characteristics and damages which were caused deliberately or through negligence.

Protection

The CamCon DC300 and this instruction manual are protected by copyright. All rights are reserved. Neither the CamCon DC300, nor this document may be copied as a whole or partially, photocopied, reproduced, translated or transferred to electronic media of any kind or into machine readable format without prior written permission by the company Digitronic Automationsanlagen GmbH.

Note: We have examined the devices of the CamCon series for year 2000 compatibility and have not found any adverse effects on any functions.

Note: CamCon is a registered trademark of the company Firma Digitronic Automationsanlagen GmbH.

Note: The devices of the CamCon series comply with the standards for electromagnetic compatibility: EN 55011, EN 55022, EN 55024 Part 2, EN 50082 Part 2, ENV 50140, VDE 0843 Part 2, VDE 0843 Part 4, VDE 0871, VDE 0875 Part 3 ("N"), VDE 0875 Part 11, VDE 0877 Part 2, IEC 801 Part 3, IEC 801 Part 2, IEC 801 Part 4, IEC 801 Part 5.



(c) Copyright 1992 - 2004 / File: DC300_E.DOC

Digitronic Automationsanlagen GmbH
Auf der Langwies 1
D-65510 Hünstetten - Wallbach
Tel. (+49)6126/9453-0 Fax. (+49)6126/9453-42
Internet: <http://www.digitronic.com>
E-Mail: mail@digitronic.com

Table of Contents

1. Introduction	8
2. Operating Principles	9
2.1. Speed Compensation	10
2.1.1. Measuring delay time for Speed Compensation	12
2.1.1.1. Measuring delay time through actual differences	12
2.1.1.2. Measuring delay time by means of different measuring points.....	12
2.1.2. Speed Compensation using off-centre pressure, e.g. brake functions.....	13
2.1.3. Separate delay time for Speed Compensation of switch-ON and switch-OFF points	14
2.2. Time - Cam	14
3. Assembly.....	15
3.1. Measurements	16
4. Electrical connections	17
4.1. Terminal assignment of the outputs.....	17
4.2. Terminal assignment of the inputs.....	17
4.3. Power supply of the CamCon	18
4.4. Terminal connections of the SSI measuring system.....	18
4.5. Terminal connections in the incremental measuring system.....	18
4.6. Terminal connections of the serial RS485 interface	19
4.6.1. Terminating resistors of the serial RS485 interface.....	20
4.7. Clampinc allocation of the serial RS232 interface (option).....	21
4.8. External interface (option).....	21
4.8.1. Pin assignments of the external interface.....	21
4.8.2. External interface with cable length of 0.4 to 300m	21
4.9. The measuring system.....	22
4.9.1. SSI Measuring system input	22
4.9.2. Parallel measuring system input.....	22
4.9.3. Incremental measuring system input.....	23
4.9.3.1. Incremental measuring system input with 5V RS422 level.....	23
4.9.3.2. Incremental measuring system input with 24V PNP level.....	23
4.9.3.3. Incremental Hiperface measuring system input with SINCOS level	24
4.9.4. Analog measuring system input.....	24
4.9.5. PLL measuring system input.....	25
4.9.6. Timer as a measuring system.....	25
4.9.7. RS232 as a measuring system	25
4.10. The outputs	26
4.11. The inputs	26
4.12. Precautionary measures for welding work	26
4.13. Status displays.....	27
4.13.1. Status LED	27
5. General programming information	28
5.1. Outline of key functions.....	29
5.2. Menu selection.....	29
5.3. Selection of a menu point	29
5.4. Text input	30
6. Initial Operation.....	31
6.1. Projecting the S7 CPU for CamCon DC300	32
7. Operation of the CamCon.....	33
7.1. The main menu.....	33
7.2. The standard display.....	33
7.2.1. Changing the display.....	33
7.2.2. Program change	34
7.2.3. Program name	34

7.3. Cam programming	35
7.3.1. Output selection for programming	35
7.3.2. Program selection for programming	36
7.3.3. Programming the delay time/speed compensation.....	36
7.3.4. Programing Time-Cams.....	37
7.3.5. Programming the output name	38
7.3.6. Cam Input	38
7.3.7. Adding cams	39
7.3.8. Cam Teach - In	39
7.3.9. Cam Search.....	39
7.3.10. Cam deletion.....	40
7.3.11. Output (cam track) deletion	40
7.3.12. Copying programmed outputs (cam tracks).....	41
7.3.13. Shifting cam tracks	41
7.3.14. Deleting programs.....	42
7.3.15. Copying programs.....	42
7.3.16. Examples for cam programming.....	43
7.3.16.1. First cam programming.....	43
7.3.16.2. Programming additional cams on an output	44
7.3.16.3. Deletion of a particular cam	45
7.3.17. Programming analog cams.....	46
7.3.17.1. Creating the first analog cam	47
7.3.17.2. Adding an analog cam	47
7.3.17.3. Changing the analog cam	47
7.4. Unit configuration (system setting).....	48
7.4.1. Measuring system	48
7.4.1.1. The standard measuring systems.....	48
7.4.1.2. The actual position hysteresis.....	48
7.4.1.3. Controlling the measuring system.....	49
7.4.1.4. The electronic gear	50
7.4.1.4.1. Electronically changing the rotation direction.....	50
7.4.1.5. The display format of the actual position	50
7.4.1.6. Configuration of a special measuring system	51
7.4.1.6.1. SSI - measuring system.....	51
7.4.1.6.2. Parallel - Gray measuring system.....	52
7.4.1.6.3. Incremental - measuring system.....	52
7.4.1.6.4. Multiturn measuring system with electronic gear	53
7.4.1.6.5. PLL measuring system	54
7.4.1.6.6. Timer way simulation (time emitter).....	54
7.4.1.6.7. RS232 measuring system.....	55
7.4.1.6.8. AG615 - Single - Multiturn - Measuring system	55
7.4.1.6.9. SIM - measuring system simulator	56
7.4.1.6.10. HIPER i.e. incremental - measuring system with Roll - Over - funktion.....	56
7.4.1.7. Deleting the special measuring system	57
7.4.2. The measuring offset.....	58
7.4.2.1. Zero offset with rotatory movements.....	58
7.4.2.2. Measuring offset with a linear moved system	58
7.4.2.3. Zero offset with linear movements.....	58
7.4.2.4. Actual position preset.....	59
7.4.3. The speed adjustment	60
7.4.3.1. The speed factor	60
7.4.3.2. The display format of the speed display	60
7.4.3.3. Range adjustment of the speed display.....	60
7.4.3.4. Accuracy of the speed display	61
7.4.3.5. Display, Type	61
7.4.4. Cable length / Cycle time	62
7.4.4.1. The cable length	62
7.4.4.2. The cycle time of the CamCon.....	62
7.4.5. The special outputs.....	62

7.4.5.1. The security output.....	62
7.4.5.2. The output of the actual position.....	63
7.4.5.3. Direction output.....	63
7.4.5.4. The standstill output.....	63
7.4.5.5. The hysteresis.....	63
7.4.5.6. The analog speed output.....	64
7.4.5.7. Configuration of the analog cams.....	64
7.4.5.8. The analog position output.....	66
7.4.6. System upgrading.....	66
7.4.6.1. Setting the inputs.....	66
7.4.6.2. Setting the outputs.....	66
7.4.6.3. Setting the outputs with speed compensation.....	66
7.4.6.4. Setting the keyboard lock.....	66
7.4.6.5. Error - acknowledging Input (EQ).....	66
7.4.6.6. Input for enableing Outputs.....	66
7.4.6.7. Setting the external program selection.....	67
7.4.6.8. Setting the program selection mode.....	67
7.4.7. Masterprogram.....	68
7.5. Unit configuration.....	69
7.5.1. User key allocation.....	69
7.5.1.1. Creating a new user key.....	69
7.5.1.2. Deletion of a user key.....	70
7.5.1.3. Checking the key configuration.....	70
7.5.2. Complete deletion.....	71
7.5.3. Unit configuration.....	72
7.5.3.1. Setting the serial interface.....	72
7.5.3.1.1. The "Cam-BUS" communication mode.....	72
7.5.3.1.2. The "Standard" communication mode.....	72
7.5.3.1.3. The "Multiuser" communication mode.....	72
7.5.3.1.4. The "S5 - L1" communication mode.....	72
7.5.3.1.5. The "3964(R)" communication mode.....	72
7.5.3.1.6. Input of the unit number.....	73
7.5.3.1.7. Programming via remote.....	73
7.5.3.2. Additional device options.....	73
7.5.3.2.1. PLC Logic Module.....	73
7.5.3.2.1.1. Examples for using the PLC logic module.....	73
7.5.3.2.2. PLC Logic Module with text display.....	74
7.5.3.3. Analog outputs.....	75
7.5.3.3.1. Clearing the integrated analog outputs.....	75
7.5.3.3.2. Adjusting the integrated analog outputs.....	75
7.5.3.3.3. External analog outputs.....	75
7.5.3.4. Locking EEPROM memory.....	76
7.5.3.5. Process alert respective Interruptfunktion.....	76
7.5.4. Language.....	77
7.5.5. Configure user.....	77
7.5.5.1. User text.....	77
7.5.5.2. User-Menu/OP-functions.....	78
7.5.6. Configure Hardware.....	78
7.5.6.1. CP16 Module.....	78
8. Device info.....	79
8.1. Stack Info.....	81
9. Error messages and removal of errors (FAQ).....	82
9.1. Problem: Display shows "No contact to unit: XX".....	82
9.2. Problem: "Pos - Err:1".....	82
9.3. Problem: "Pos - Err:2".....	82
9.4. Problem: "Pos - Err:3".....	83
9.5. Problem: "Pos - Err:5".....	83
9.6. Problem: An "Pos-Error:" occurs during operation.....	83
9.7. Problem: "RAM-Full" = RAM memory is full.....	83

9.8. Problem: The EEPROM memory is full.....	84
9.9. Problem: Outputs will not activate.....	84
9.10. Problem: "Out - Error".....	84
9.11. Problem: Error in the EEPROM.....	84
9.12. Problem: "Error ???".....	84
9.13. Problem: "Clear....".....	85
9.14. Problem: The S7 CPU goes into Stop or invokes OB121.....	85
9.15. Problem: The S7 CPU does not go into RUN.....	85
10. Menu outline.....	86
11. Calculation EEPROM cam storage.....	87
12. Calculation the RAM storage-requirement for CamCon.....	88
13. Communication between S7 and CamCon DC300.....	89
13.1. Installation of the S7 Software.....	89
13.2. Required Blocks and Networks.....	89
13.3. OB1.....	90
13.4. FB51 - Main Module.....	90
13.4.1. Parameter of the FB51.....	91
13.5. FC51 - I/O Copy Program.....	94
13.6. FC52, 53, 54 and 55 - Subroutines of FB51.....	94
13.7. OB100 - Startup block.....	94
13.8. OB40 - Process Interrupt Function or Interrupt Function.....	94
13.9. DBxx - Data block for cam data.....	95
13.9.1. DBxx range 1 = Status.....	95
13.9.2. DBxx range 2 = Cams table.....	96
13.9.3. DBxx range 3 = Delay Times.....	96
13.9.4. DBxx range 4 = RK512 Table.....	97
13.10. High-speed Actual Value and Speed Value Transmission.....	98
14. CamCon data transfer generell.....	99
14.1. Question sequence.....	99
14.1.1. Answer sequence, related to questions.....	99
14.2. Command sequence.....	99
14.2.1. Command acknowledgement.....	99
14.3. Acknowledgement for unknown question or command.....	99
15. Possible commands.....	100
15.1. Request on 0x01.....	100
15.2. Error-reset of the CamCon camswitch 0x02.....	100
15.3. Programmchangel of the CamCon camswitch 0x03.....	100
15.4. Reading a CamCon camswitches' camtrack 0x04.....	101
15.5. Programing the Cam-track of a CamCon camswitch 0x05.....	101
15.6. Reading the CamCon camswitches' delay time 0x06.....	102
15.7. Programming a CamCon camswitches' delay time 0x07.....	102
15.8. RK512 Commands.....	103
15.8.1. RK512 Reading a command.....	103
15.8.2. RK512 Writing commands.....	103
15.8.3. List of possible RK512 commands.....	104
16. Technical data of the CamCon.....	106
17. Key word table.....	107

1. Introduction

Electronic Cam Switch Units have been successfully used in industry for a long time. Experiences collected in close liaison with users over the years have been included in the development of the CamCon series. The result is a compact digital cam switch unit which is user friendly and reliable to a high degree. The following characteristics testify the excellence of the CamCon:

- * Tested and reliable hardware
- * Short-circuit-proof outputs
- * Graphic liquid crystal display with 128x64 pixels in the CamCon DC50,51.
- * Large and clearly visible 7-Segment display for program, position and speed on CamCon DC30,33 and 40.
- * Any number of cams per output can be programmed.
- * Up to 32000 Programs for product administration
- * Master, for example: machine cams
- * Optimising switch points when machine is in operation
- * Compensation of mechanical delay time of switch components for switch-ON and switch-OFF points can be set in steps of 100µs separately (DTC = delay time or Speed Compensation).
- * Position - Triggert - Time - Cams
- * Power supply 24V DC +/- 20%
- * Mounting of suspension rails to EN 50022 on CamCon DC16 and 90
- * Switchboard panel standard casing 144 x 144 x 63mm to DIN 43700 on CamCon DC33,40 and 51
- * S5 Components group for S5 115U, 135U and 155U on CamCon DC115
- * S7 Components group for S7 300 on CamCon DC300
- * AB Components group for ControlLogix[®] 1756 on CamCon 1756-DICAM
- * S5 Switch-ON via PG interface with L1 - Bus on CamCon DC16,40,50,51 and 90
- * PLC Logic Module (optional)
- * Shift register (optional)
- * OP - Functions
- * Analog outputs (optional)

Cam switch units are used wherever switching operations are periodically repeated. Digital cam switch units are an optimum replacement of mechanical units and offer in addition many other advantages, such as:

- * Simplification of mounting and adjustment operations
- * Repeatable adjustment facility
- * Standardised for almost all areas of application
- * Reliability
- * High switch speed
- * Speed Compensation
- * Product administration for quick format change

2. Operating Principles

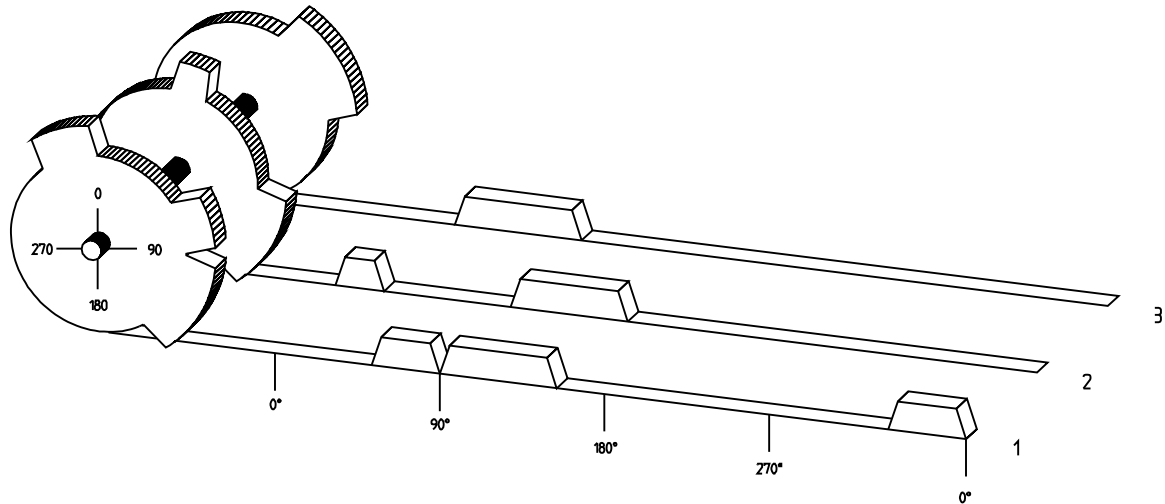

Diagram: Principles of a Cam Switch Unit

A principle for better comprehension of the function of a Cam Switch Unit is here presented. It has 3 outputs with the following cams:

Output 1:	Cam 1:	Switch-ON position	60°	Switch-OFF position	85°
	Cam 2:	Switch-ON position	95°	Switch-OFF position	145°
	Cam 3:	Switch-ON position	325°	Switch-OFF position	355°
Output 2:	Cam 1:	Switch-ON position	5°	Switch-OFF position	20°
	Cam 2:	Switch-ON position	95°	Switch-OFF position	145°
Output 3:	Cam 1:	Switch-ON position	30°	Switch-OFF position	85°

The positions of the output signals, here presented as three tracks, occur when the three cam disks turn anti-clockwise past a sensor, which scans the cams on the 0°-axis.

In a mechanical cam switch unit, the switch interval, i.e. the range between switch-ON and switch-OFF position are determined by the length of the cam. The length and the position of the cam can only be varied marginally and this is mechanically highly demanding and time consuming. With CamCon such adjustments can be realised in a fraction of time; in addition, there can be any number of tracks. A measuring system which is fitted to the device reports the position to the CamCon. The CamCon compares it with the programmed switch-ON and Switch-OFF positions of all outputs. If the position lies in the range of a programmed switch-ON / switch-OFF position (cam), then the respective outputs are active.

2.1. Speed Compensation

Each mechanical switch component (e.g. shield, magnetic valve) has a delay time, i.e. the time between the start signal and the actual switching of the contacts. In processes where positioning is executed on a moving system, this can cause problems. If such a process is driven with different speeds, different positions are caused. To avoid this happening, new timings for the switch signals of each speed would have to be calculated.

In order to illustrate the complicated issues surrounding delay time or speed compensation, this will be shown on the example of a packaging machine. In the process shown in the diagram, a glue point has to be placed in an exactly defined spot on a moving paper track.

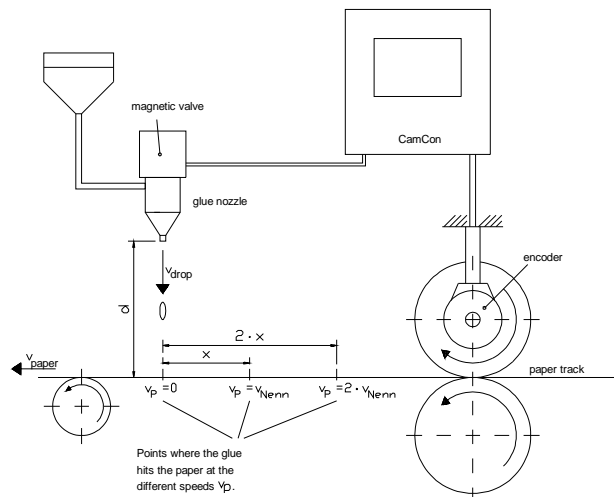

The system has the following parameters:

- v_p - Speed of the paper track
- v_T - Falling speed of the drop of glue
- d - Distance between the glue nozzle and the paper track
- T_{MV} - Delay time of the magnetic valve

Without speed compensation the following would happen:

As soon as the measuring system has reached a certain position, the CamCon sends a signal to the magnetic valve. The glue nozzle opens for a short time during which a drop of glue ejects. Between the start of the impulse and the exit of the drop time passes, which is mainly caused by the delay time of the magnetic valve T_{MV} . A further delay is caused by the time which the droplet needs to pass the distance between the glue nozzle and the surface of the paper.

This flight time is calculated as follows:

$$t_{Flight} = \frac{d}{v_T}$$

In total there the delay time is $t_{Flight} + T_{MV}$. During this time the paper track moves on by a specific distance x .

It would now be possible to move the position, where the magnetic valve is switched on, forward by a specific amount, so that the glue droplet hits the same spot again as during standstill. In this way a speed compensation is created which works only at a specific speed of the paper. As soon as the speed of the device and consequently that of the paper track is, for example, doubled, the hit point of the glue droplet is shifted by the distance x , so that, without any speed compensation, it would move backward by double the distance ($2 \cdot x$) in total.

The automatic speed compensation of the CamCon makes it now possible to drive processes with variable speed; CamCon registers the speed of the device continuously and adjusts the cams which determine the switch time points "On Line" depending on the speed. This has the effect that the outputs for the switch components are switched ON or OFF earlier. The direction of the movement is of no significance in this instance.

A small example in figures was designed to elucidate:

Supposing the drive cylinder with the measuring system has a circumference of 360mm, so that one millimeter of the circumference corresponds to exactly one angle degree of the measuring system.

The device has the following parameters:

$$\begin{aligned}v_{\text{droplet}} &= 20\text{m/s} \\d &= 20\text{cm} \\T_{\text{MV}} &= 20\text{ms}\end{aligned}$$

This results in the following flight time of the droplet:

$$t_{\text{Flight}} = \frac{d}{v_T} = \frac{0,2\text{m}}{20\text{m/s}} = 10\text{ms}$$

The total delay time is then $T_{\text{dead, altogether}} = T_{\text{MV}} + t_{\text{Flight}} = 20\text{ms} + 10\text{ms} = 30\text{ms}$

During this time the paper track moves on by the distance $x = v_{\text{paper}} \cdot T_{\text{total delay}} = 1\text{m/s} \cdot 30\text{ms} = 30\text{mm}$. In order to compensate the delay time, the switch point for the magnetic valve must be moved forward by 30°.

If the speed of the device and consequently that of the paper is doubled v_{paper} , then the distance x is also doubled by the speed of the paper track. In this case the switch point must be moved by 60°.

Note: Please take into account in these explanations that delay time is of a fixed size, which is determined by the mechanical constants of the set and switch components and by the dimensions of the construction and therefore does not change!

If the total delay time of 30ms was programmed into the respective output of CamCon, then the glue droplet would always hit the right spot, regardless of the speed.

2.1.1. Measuring delay time for Speed Compensation

Several ways of measuring delay time of a relay or valve are available.

2.1.1.1. Measuring delay time through actual differences

First the switch-ON point of a valve or relay is programmed. We assume that the programmed switch point lies at 200 degrees in this case. If the machine is driven with a speed of for example 40 rpm, a shift occurs due to delay time. This shift is then measured and, in this example, will amount to 40 degrees.

Warning: For the calculation of the shift the programmed delay time in the cam switch unit must be set to zero!

The delay time of the switch component is now calculated as follows:

$$\text{Delay time (in sec.)} = \frac{\Delta \text{ way (in } ^\circ \text{)} * 60 \text{ (sec./min.)}}{\text{speed (in rpm)} * 360 \text{ (} ^\circ\text{/turn)}}$$

$$\text{Delay time (in sec.)} = \frac{40 * 60}{40 * 360} = 0.1667 \text{ sec.}$$

The resultant delay time is then entered into the cam switch unit.

See Chapter "7.3.3. Programming the delay time" an page 35.

2.1.1.2. Measuring delay time by means of different measuring points

First the switch point is calculated at a speed of, for example, 50 rpm. We assume that the programmed switch point lies at 200° in this case. The second measurement is taken at a speed of 80 rpm. The necessary switch point must be set to 160°, if the exact switch point is to be also achieved at 80 rpm.

Warning: For the calculation of the two switch points the programmed delay time in the cam switch unit must be set to zero!

The delay time of the switch component is then calculated with the following formula:

$$\text{Delay time (in sec.)} = \frac{\Delta \text{ way (in } ^\circ \text{)} * 60 \text{ (sec./min.)}}{\Delta \text{ speed (in rpm)} * 360 \text{ (} ^\circ\text{/turn)}}$$

$$\text{Delay time (in sec.)} = \frac{40 * 60}{30 * 360} = 0.222 \text{ sec.}$$

The resultant delay time is then entered into the cam switch unit.

See Chapter "7.3.3. Programming the delay time" an page 35.

Since the entered delay time shifts the switch point, the previously programmed cam must be changed. For the calculation of the exact switch-ON position, the difference to the speed 0 rpm (here using 50 rpm) must be added to the first measured switch-ON point (here 200°). The difference is calculated with the following formula:

$$\Delta \text{ way (in degrees)} = \frac{\text{dead time (in sec.)} * \Delta \text{ time (in min}^{-1}\text{)} * 360 \text{ (degrees/rotations)}}{60 \text{ (sec./min.)}}$$

$$\Delta \text{ way (in degrees)} = \frac{0.222 * 50 * 360}{60} = 66.6 \text{ degrees}$$

The switch-ON point of the cam is now shifted from 200° by approx. 67° to 267°.

2.1.2. Speed Compensation using off-centre pressure, e.g. brake functions

The Speed Compensation of the CamCon Cam switch unit works using a linear function. If, for example, the speed doubles, then the shift of the compensated cam changes and also moves forward by twice the amount. If the ram on an eccentric press should be brought to a standstill at the exact upper stop point, the brake action of the press under different speeds results in a quadratic function. The Speed Compensation can therefore only find an approximation of the exact switch point for the stopping of the press by adjusting the line of the cam lines to the brake curves in the working range of the press.

In the graphic on the right the curved line represents the brake point of the ram in relation to the speed.

For the calculation of the parameters to be programmed please proceed as follows:

- Define the working range (e.g. 20-50 rpm) and determine two measuring points which have to be specified in the working process (e.g. 30 and 40 rpm).
- Now let the machine run at 30 rpm and program or optimise a cam **without** Speed Compensation so that, at switch-OFF, the ram comes to a halt in top stop. Note the switch-ON point of the cam (e.g. 340°).
- Now let the machining work with 40 rpm and program or optimise one cam **without** Speed Compensation so that, at switch-OFF, the ram comes to a halt in top stop. Once again, note the switch-On point of the cam. (e.g. 332°).
- Now calculate the delay time, taking into account the distance and speed difference, using this formula:

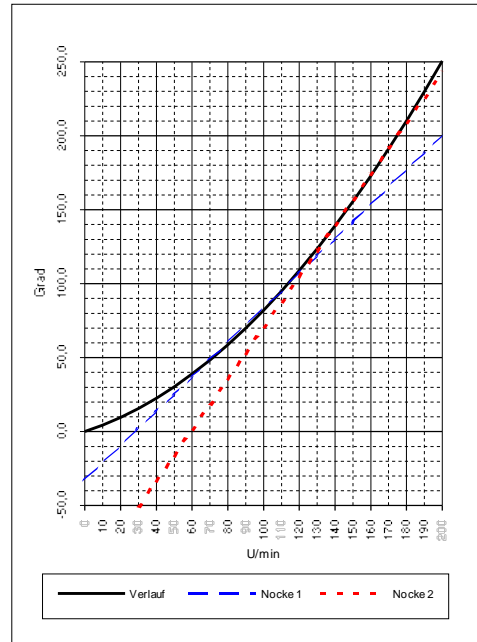

$$\text{Delay time (in sec.)} = \frac{\Delta \text{ way (in } ^\circ \text{)} * 60 \text{ (sec./min.)}}{\Delta \text{ Speed (in rpm.)} * 360 \text{ (} ^\circ \text{/turn)}} = \frac{340-332 * 60}{40-30 * 360} = 0.133 \text{ sec.}$$

- The calculated delay time is now entered into the cam switch unit.
- Since the switch-OFF point has shifted through the entered Speed Compensation, the previously programmed cam must be changed first. For the calculation of the exact switch-ON position, the difference to the speed 0 rpm (here 30 rpm) must be added to the first measured switch-ON point (first measuring point here 340°) The difference is calculated with the following formula:

$$\Delta \text{ way (in } ^\circ \text{)} = \frac{\text{delay time (in sec.)} * \Delta \text{ Speed (in rpm.)} * 360 \text{ (} ^\circ \text{/turn)}}{60 \text{ (sec./min.)}} = \frac{0.133 * 30 * 360}{60} = 23.94^\circ$$

- The switch-ON point of the cam has now shifted from 340° by approx. 24° to 364°.

As a result a cam with a switch-ON point of 4° and a speed compensation of 0.133 sec has been calculated. This is entered in the cam switch unit as switch-OFF cam of the press.

Note: If the degree of accuracy is no longer sufficient when switch-OFF is done with one cam, two or several outputs can be switched in parallel and the cam of those is then adjusted to the required working range. For the calculation of two switch-OFF cams divide the working range in 5 parts with 4 measuring points and then calculate the delay time value and the cam value with the same formula as described above. For the calculation of the first cam, use the measuring points 1 + 2 and for the calculation of the second cam use the measuring point 3 + 4.

Through this association of the linear cam functions to the brake functions it is now possible to switch OFF the cam via the entire working range of the press in the top stop.

2.1.3. Separate delay time for Speed Compensation of switch-ON and switch-OFF points

For CamCon devices of Software from 3/2002 Speed Compensation is now available for separate switch-ON and switch-OFF points. This is necessary since some valves need longer to switch OFF than to switch ON.

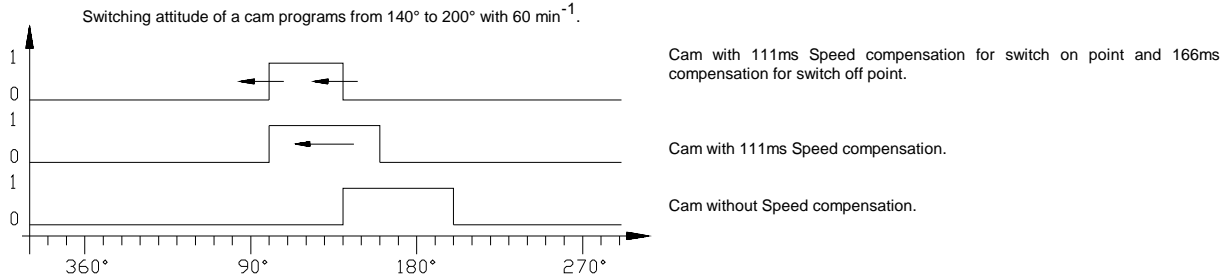

For the calculation of both delay times the same formulæ are used as for a *normal* compensation. See Chapter "2.1.1. Measuring delay time for Speed Compensation" on page 11 for entering delay time see Chapter "7.3.3. Programming the delay time" on page 35.

Attention: If the switch-off-point of a Cam overtakes the switch on point at rising speed, the result will be an non-defined signal.

2.2. Time - Cam

With normal cam becomes with increasing plant speed switch-on time ever more briefly. If controlling a glueing-station, the result would be an insufficient amount of spreaded glue.

A Time - cam however has with each plant speed a firm temporal length, so that exactly the same amount of glue could be spread at changing speeds. The switch-on point of the Cam on a *normal* as well as on a Time-Cam is appointed by a position-dependent Position value and a delay-time/speed compensation.

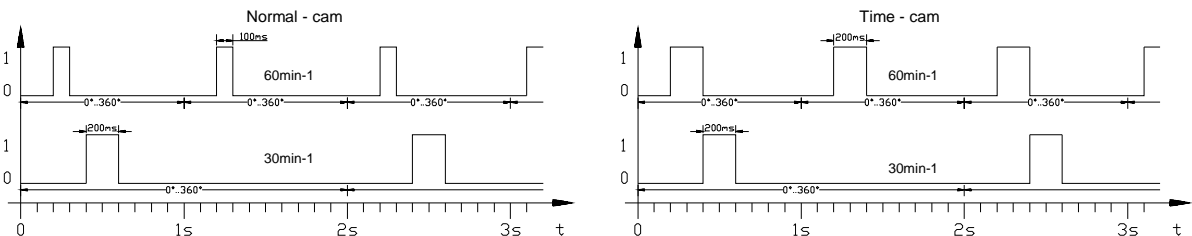

For CamCon devices of software releases after 3/2002 Time Cam is also available for devices without PLC - Logic - Module.

For entering a Time - Cam see Chapter "7.3.4. Programing Time-Cams" on page 36.

3. Assembly

- * All assembly work and cable connections are to be done in an idle state!
- * Refer to the manual, "S7-300 Automatiion System, Set-up and CPU Data ", order no.: 6ES7 398-8AA01-8AA0.
- * Switch the S7 CPU to Stop and disconnect the power supply of the sub-rack, in which you wish to install the CamCon DC300.
- * A maximum of 8 S7 subassemblies (SM, FM, CP or CamCon DC300) may be inserted in an S7 BUS to the right of the S7 CPU or in an expansion rack.
- * The current consumption (5V) of all subassemblies on an S7 sub-rack may not exceed the maximum current delivery of the S7 CPU or of the IM module. You must refer to the manual for the S7. The current consumption of the CamCon DC300 is typically 450mA.
- * A bus connector is attached to the DC300 subassembly. You plug these into the backplane bus port of the subassembly left of the DC300. If other subassemblies are supposed to be assembled to the right of the CamCon DC300 Module, plug the bus connector of these into the connector of the DC300.
- * ! If using errorproof F - subassemblies in your 7, the CamCon DC300 must not be placed between the F-CPU and an F-subassembly.
- * ! If using the DC 300 at an IM153 - ET200M - switching, the Cam outputs 33-48 can only be used, if the CamCon's PLC-Logic module is activated, for an enableing of the outputs by the S7 is impossible.
- * Mount the DC300 on the mounting rail and screw the device tightly with the cylinder screw to the bottom part of the casing in the mounting rail.
- * The DC300 subassembly is grounded through the grounded sub-rack of the S7.
- * The connecting cable for the measuring system and the serial interface must be laid shielded and the shield must be connected to earth on both ends. For this, you need the shield termination element of S7, order no.: 6ES7 390-5AA00-0AA0, and the shield connection clamp, order no.: 6ES7 390-5CA00-0AA0. These are not included with the CamCon DC300. Secure the shield termination element with the two M5 screws to the mounting rail directly underneath the DC300 subassembly. Guide the connecting cable of the measuring system from behind under the termination element and clamp the uncovered shield braiding of the connecting cable with the shield connection clamp.
- * Now, insert the 40-pole connector plug with the order no.: 6ES7 392 - 1AM00-0AA0 (**Note:** not included with the CamCon DC300) into the subassembly and wire the CamCon DC300 according to the pin configuration Chapter "4. Electrical connections" on page 16.
- * After all the cable connections have been made, the initial operation can proceed. See Chapter "6. Initial Operation" on page 30.

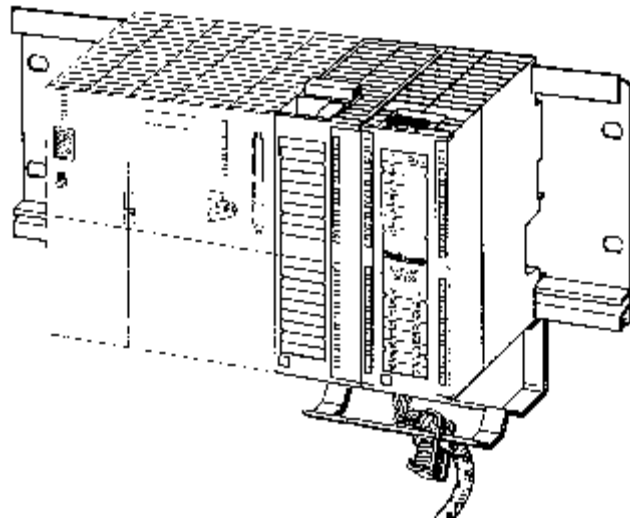

Note: For the installation of the DC300 in Step 7, programming interface, please see the Chapter "6.1. Projecting the S7 CPU for CamCon DC300" on page 31.

Note: You may order the shield termination element, the shield connection clamp and the 40 - pole connector plug as a complete set from Digitronic under Order No.: DC300/ZB.

3.1. Measurements

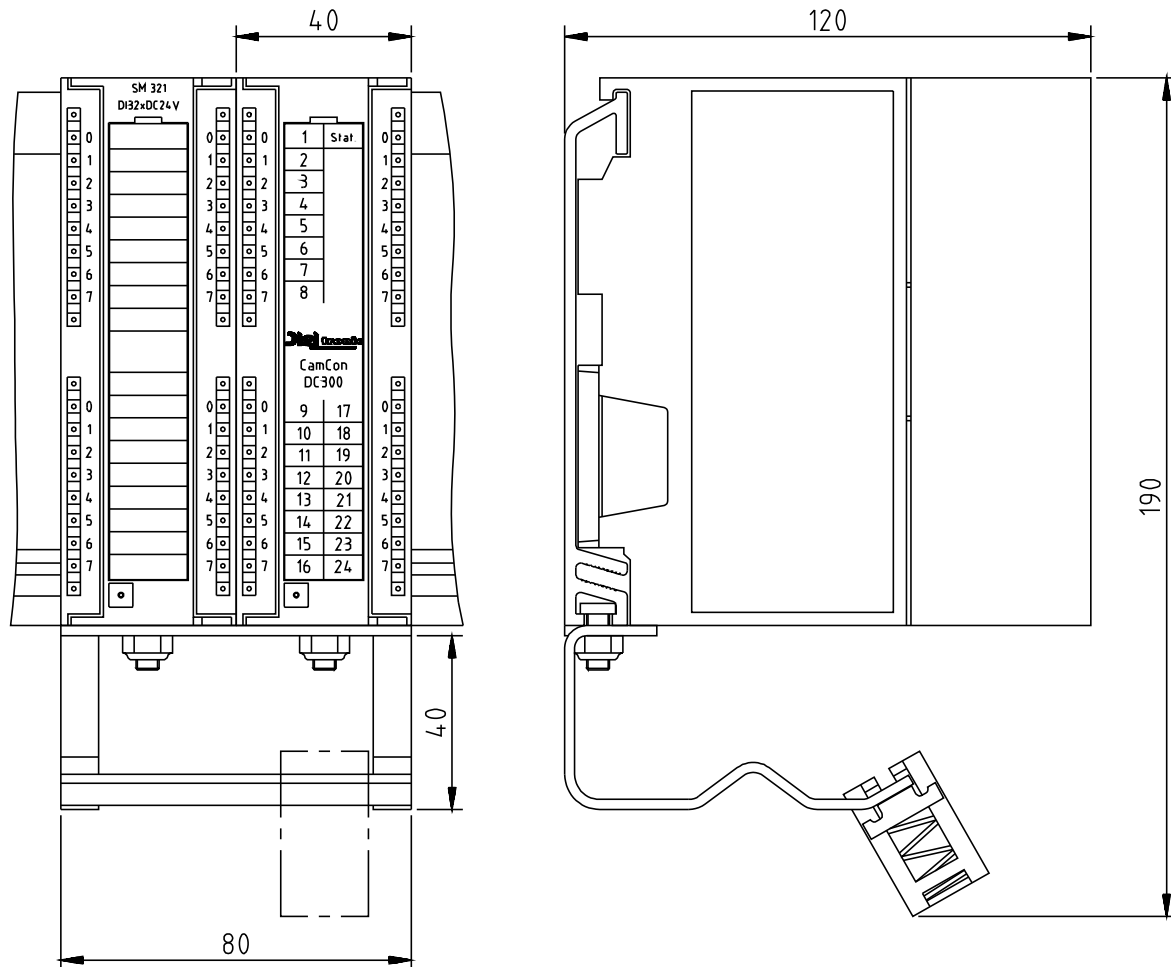

The diagram shows a CamCon DC300, a Siemens output module SM321 with shield termination element and shield connection clamp.

4. Electrical connections

Before you begin with wiring, please consult the following chapters: "4.10. The outputs" on page 25, "4.11. The inputs" on page 25 and "4.9. The measuring system" on page 21.

4.1. Terminal assignment of the outputs

Terminal 1: +24V power supply outputs 1 - 8
Terminal 2: Output 1
Terminal 3: Output 2
Terminal 4: Output 3
Terminal 5: Output 4
Terminal 6: Output 5
Terminal 7: Output 6
Terminal 8: Output 7
Terminal 9: Output 8
Terminal 10: 0V

Terminal 11: +24V power supply Outputs 9 - 16
Terminal 12: Output 9
Terminal 13: Output 10
Terminal 14: Output 11
Terminal 15: Output 12
Terminal 16: Output 13
Terminal 17: Output 14
Terminal 18: Output 15
Terminal 19: Output 16
Terminal 20: 0V

Terminal 31: +24V power supply Outputs 17 - 24
Terminal 32: Output 17 / Input 8
Terminal 33: Output 18 / Input 7
Terminal 34: Output 19 / Input 6
Terminal 35: Output 20 / Input 5
Terminal 36: Output 21 / Input 4
Terminal 37: Output 22 / Input 3
Terminal 38: Output 23 / Input 2
Terminal 39: Output 24 / Input 1
Terminal 40: 0V

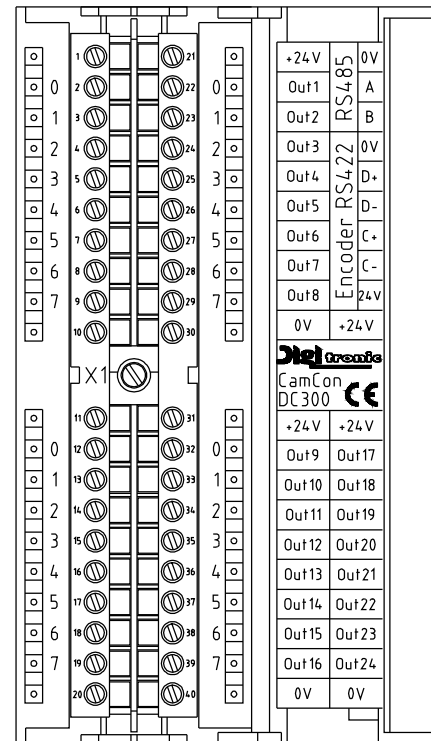

4.2. Terminal assignment of the inputs

The connecting terminals of inputs 1 - 8 and outputs 17 - 24 are used twice. If, for example, output 24 is set, input 1 is also active.

Attention: The powersupply at terminal 31 must also be connected if the outs 17 - 24 are used as inputs only. **F**

Terminal 31: +24V power supply Outputs 17 - 24 or inputs 1-8
Terminal 32: Input 8 / Output 17
Terminal 33: Input 7 / Output 18
Terminal 34: Input 6 / Output 19
Terminal 35: Input 5 / Output 20
Terminal 36: Input 4 / Output 21
Terminal 37: Input 3 / Output 22
Terminal 38: Input 2 / Output 23
Terminal 39: Input 1 / Output 24
Terminal 40: 0V

Note: The terminals 10, 20, 24 and 40 are connected to one another.

4.3. Power supply of the CamCon

Terminal 30: +24V power supply for measuring system and internal hardware.

The CamCon DC300 is powered by the bus of the S7 with 5V (approx. 350mA current consumption). In addition, the peripheral equipment of the DC300 must be externally supplied with power since it is electrically isolated from the S7 BUS. There is no electrical isolation for the serial interface. +24V power supply at Terminal 30 is needed for the basic operation of the peripheral equipment (external interface and measuring system (encoder)). The power supply of the outputs must be connected for each output block, since, for better current distribution, these are not connected to one another. 4 status LEDs indicate contact with each individual distribution voltage.

4.4. Terminal connections of the SSI measuring system

Terminal 24: 0V power supply of the SSI measuring system (angle encoder)
Terminal 25: Data A or Data +
Terminal 26: Data B or Data -
Terminal 27: Clock A or Clock +
Terminal 28: Clock B or Clock -
Terminal 29: +24V DC power supply of the SSI measuring system (angle encoder)

+24V	0V
Out1	A
Out2	B
Out3	0V
Out4	D+
Out5	D-
Out6	C+
Out7	C-
Out8	+24V
0V	+24V



4.5. Terminal connections in the incremental measuring system

Terminal 24: 0V power supply of the incremental measuring system (angle encoder)
Terminal 25: A impulse
Terminal 26: B impulse
Terminal 27: Clear 1
Terminal 28: Clear 2
Terminal 29: +24V DC power supply of the incremental measuring system (angle encoder)

+24V	0V
Out1	A
Out2	B
Out3	0V
Out4	A
Out5	B
Out6	C1
Out7	C2
Out8	+24V
0V	+24V



The signals Clear 1 and Clear 2 are for the setting to 0 as standart AND connected. Their function can be changed by the software. See also chapter "7.4.1.6.3. Incremental - measuring system" on page 51.

Note: Terminals 10, 20, 24 and 40 are connected to one another.

Note: Terminals 29 and 30 are connected to one another.

4.6. Terminal connections of the serial RS485 interface

The CamCon DC300 usually comes with a serial RS485 interface. This is used for programming through a PC or a CamCon DC50/51 terminal. The cable length for this RS485 interface is limited to a maximum of 1000m. Please refer to the chapter "7.5.3. Unit configuration" on page 71.

- Terminal 21: 0V Signal ground, also internal ground S7 bus.
- Terminal 22: A (+)
- Terminal 23: B (-)

Important: The RS485 interface to the S7 CPU is not isolated. A wrong connection or wrong voltage may destroy the entire S7 SPS.

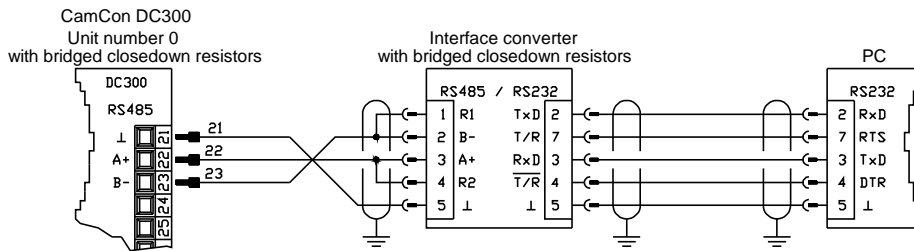
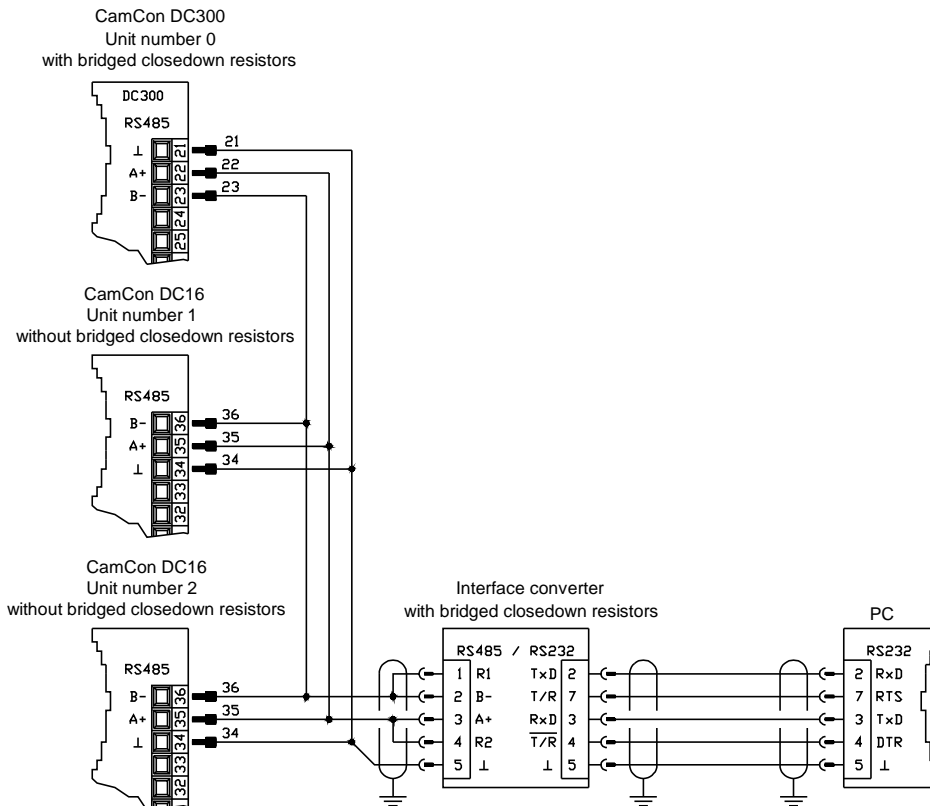
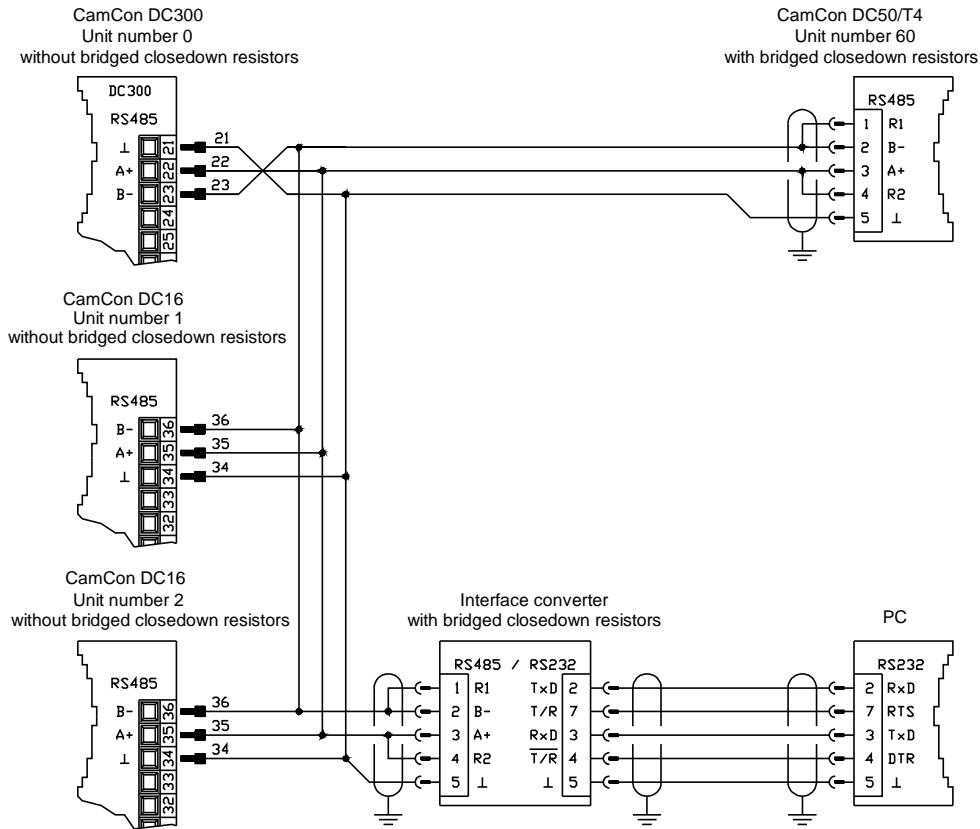

Illustration : Point to point operation, DC300 and PC



Illustr.: Mixed operation, DC300, DC16 and PC

Please note: In the RS485 interface, the ends of the data line must be wired with closedown resistors. There are two DIP switches in the CamCon DC300 for this purpose that are to be set before starting. These may be closed only at the start and at the end of a cross-linked chain or an individual device, as well as an interface converter (Pin 1 with 2 and Pin 3 with 4). In the CamCon DC300, these are closed at the factory; they must consequently be opened for multiple machine operation.



Illustr.: Mixed operation, DC300, DC16, DC50/T4 and PC

4.6.1. Terminating resistors of the serial RS485 interface

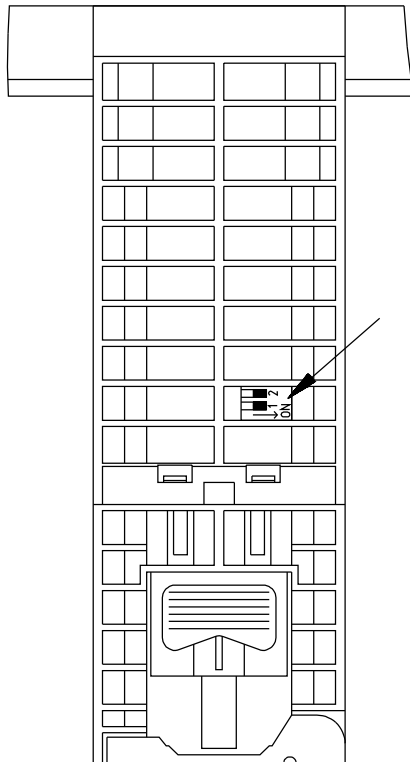

To be able to switch the terminating resistors of the CamCon DC300 on or off, a two-pole DIP switch can be set by means of a screwdriver on the top side of the subassembly. If the switches are closed (ON), the RS485 line is terminated with a resistance of 390/150/390 Ohms. The switches may only be both closed (ON) or both open, or the asymmetrical load will otherwise interfere with the data transmission.

Illustr.: Top side of CamCon DC300

4.7. Clamping allocation of the serial RS232 interface (option)

Since december 2002 the CamCon DC300 can be equipped optionally with an RS232 interface. The maximum wiring distance is limited to 10m. Please absolutely regard chapter "7.5.3. Unit configuration" on page 71.

Clamp: 21: 0V Signal GND
Clamp: 22: RxD
Clamp: 23: TxD

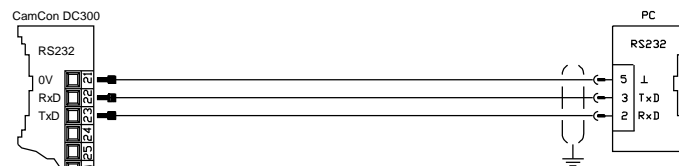

Attention: The RS232 interface is not free of potentials towards the CPU. A wrong wiring respective a wrong voltage may cause the destruction of the entire S7.

4.8. External interface (option)

If the external interface is also ordered together with the CamCon DC300 (indicated with an X at the end of the order number), you will later have the option of expanding the CamCon through a CamCon DC16/IO or DAC16 module.

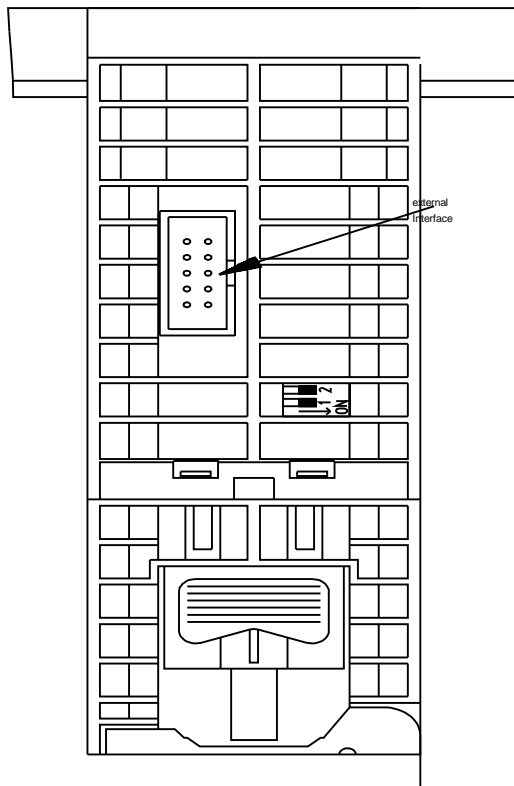

The extension modules are clipped on to a mounting rail NS 35 / 7.5 (DIN 50022) NS 35 / 15 (DIN 50022) NS 32 (DIN 50035) in the control box and are connected with the DC300 through a 10-pole flat twin cable. This cable is not included, and must be ordered separately. The CamCon expansion module must be built in right next to the S7 because the maximum cable length of 40cm may not be exceeded. The external interface of the CamCon DC300 is connected to the CamCon module using the 10-pole pin plug "ext.Int.IN", and, through the output "ext.Int.OUT", can be connected at this module to another CamCon module. The data transfer is isolated through opto-couplers.

4.8.1. Pin assignments of the external interface

Pin	1,4,7,10:	earth
Pin	2:	TxD -
Pin	3:	TxD +
Pin	5:	CLK -
Pin	6:	CLK +
Pin	8:	RxD -
Pin	9:	RxD +

Illustr.: top side of CamCon DC300

4.8.2. External interface with cable length of 0.4 to 300m

The maximum cable length of the external interface is 300 metres. For this, a shielded 6-pole data cable with lead stranded in pairs and an adapter cable of 10-pole flat twin cable on a 9-pole DSUB connector is required. The shielding of this cable must be connected to earth on both sides.

4.9. The measuring system

The measuring system is designed to record the necessary actual values (positions) for the Cam Switch Unit. Many different measuring system can be linked with the CamCon.

See chapter "4. Electrical connections" on page 16 and for adjustment of the measuring system to the software of the CamCons please also consult Chapter "7.4.1. Measuring system" on page 47.

Note: Please also consult the instruction manual for your measuring system.

4.9.1. SSI Measuring system input

Systems with a synchronous series interface = SSI. The SSI interface is widely used in industry for absolute single and multi-turn angle encoder. At this interface the CamCon supplies the measuring system with 24Volt. For the purpose of data reading the CamCon sends a stroke signal (clock) with RS422 level to the measuring system. This answers synchronously with the data output of the position in the grey code. The frequency of the pulse signal depends on the length of the cable to the measuring system and can be set in the CamCon.

Note: The data record corresponds to the Stegmann SSI Standard!

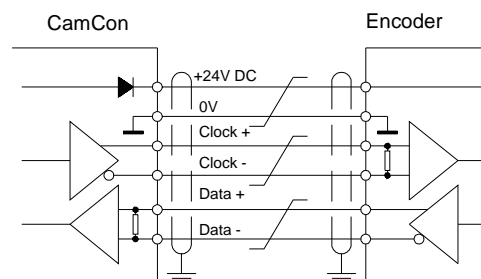
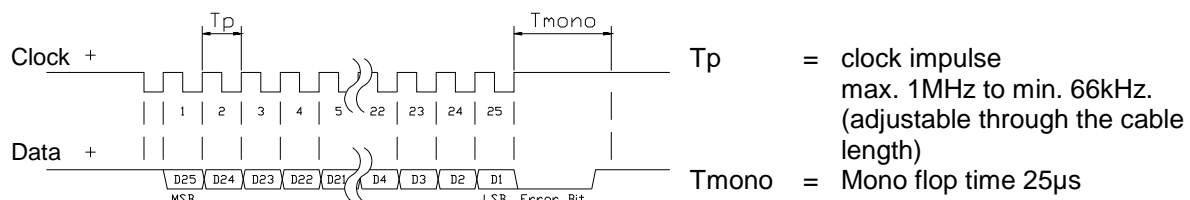

Please note:

Use a screened dual strand connection cable. Do not place the cable parallel to a high voltage cable. If possible, lay the screening down on both sides.

4.9.2. Parallel measuring system input

Systems with parallel 24V data leads, e.g. single turn - angle encoder or via a transformer with parallel data output.

In this instance a gray or binary encoded value is attached to the free inputs of the CamCon and this will be read as actual value. Since the connection cable are quite expensive and the EMV - compatibility is limited, this interface type is rarely used in industry nowadays.

Note: Since the outputs are partly switched parallel to the inputs in CamCon DC16, DC115, DC300 and CamCon 1756-DICAM, these must not be programmed under any circumstances and this reduces the number of available outputs.

Warning: Reading a binary encoded value into the CamCon is only permitted after consultation with the Service department of the company Digitronic.

4.9.3. Incremental measuring system input

Systems with 90° phase shift signals such as turning angle encoders, glass measuring rods or flow measuring devices.

At the present time incremental measuring inputs for the CamCon DC16/50/51/115/300 and DC1756 are available as an option. We differentiate between three signal levels:

- 24V PNP Signal inputs (Order number Option: J)
- 5V RS422 Signal inputs (Order number Option: I)
- Hiperface Signal inputs (Order number Option: H)

Note: For the CamCon DC16 and DC300 only the version with 24V PNP signal is available. For the CamCon 1756-DICAM the version with 24V PNP signal and Hiperface Signal is available. If a different signal level is necessary, this can be converted externally with the INCDRV converter.

In all cases the CamCon supplies the measuring system with 24Volt/DC or in CamCon DC115 optionally with 5 or 24Volt/DC. As a counting signal the measuring system gives out two impulses at a time shifted by 90° (A + B). These are counted in the CamCon and are evaluated as position values. In addition, for each rotation another zero impulse (Clear 1) is given out for synchronisation purposes. In order to stop synchronisation (zero setting) of the counter, a further clear signal (Clear 2) is available on the CamCon.

The signals Clear 1 and Clear 2 are to standard AND linked and can be changed in their function with the software. See Chapter "7.4.1.6.3. Incremental - measuring system" on page 51

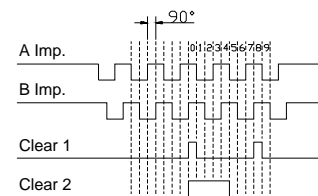

4.9.3.1. Incremental measuring system input with 5V RS422 level

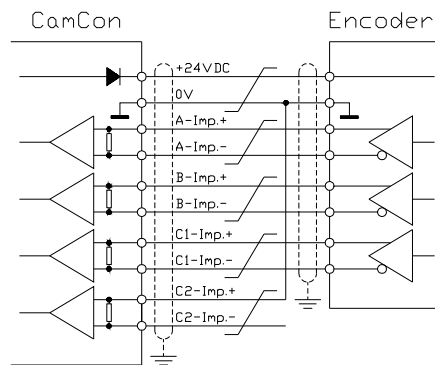

If the 5V RS422 system is used, all signals of the measuring system input must be active, otherwise the input conditions are undefined. If no signal is available for one of the two Clear inputs, then this input must be switched to mass on the (+) signal in order to switch the input to low. The inputs of the measuring system can be activated with a maximum voltage of 5V. Please pay attention to the power supply of the angle encoder which can be 5Volt as well as 24Volt. Only the CamCon DC115 can at present provide a voltage of 5Volt for the supply of the angle encoder.

4.9.3.2. Incremental measuring system input with 24V PNP level

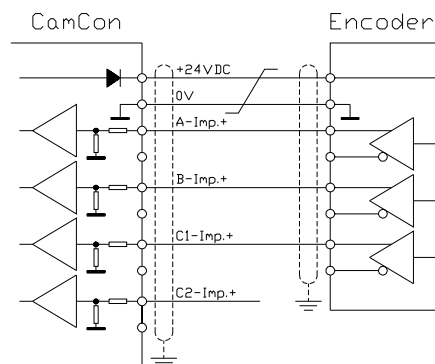

If a 24V PNP signal is used for data input, then only the (+) signals of the inputs may be connected. The (-) signals must stay inactive in this case. The connection of such a measuring system requires a change of the internal switch system and must therefore be stated on the order form.

Note: At the incremental input of the CamCon DC16, DC300 and DC1756 no (-) signals are available.

4.9.3.3. Incremental Hiperface measuring system input with SINCOS level

The Hiperface measuring system is a feedback system for servo-motors of the company Stegmann.

It is a mixed system and consists of an absolute measuring system and an incremental measuring system. The absolute measuring system sends its values via RS485 interface to the counter. The incremental measuring system works with analog sine - and cosine interface with a resolution of 512 or 1024 impulses per revolution.

The CamCon with the Hiperface signal input (option: H) reads only the incremental sine - and cosine signal. The signals are converted and counted in the CamCon into normal incremental measuring system signals.

Since the absolute measuring system of the Hiperface interface is not used and no clear - signals are available, the CamCon must be initialized after each restart.

This must be done by the preset input of the CamCon. See for this to chapter 7.4.2.4. Actual position preset on page 58.

Note: The maximum number of revolutions per minute is 3000 min^{-1} with 512 Impulse per revolution. The maximum number of revolutions per minute is 1500 min^{-1} with 1024 Impulse per revolution.

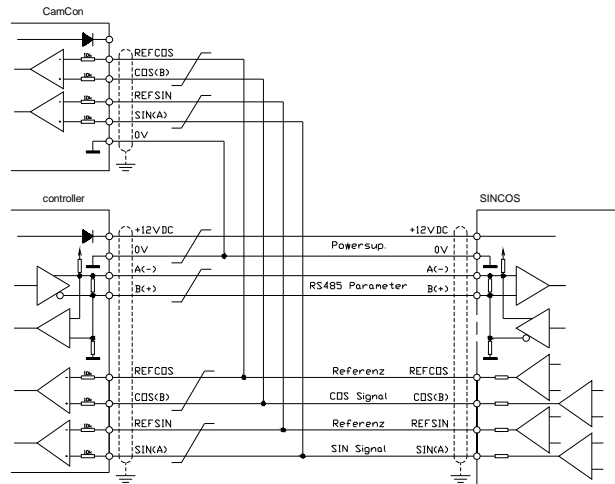

4.9.4. Analog measuring system input

These are systems which receive their actual value through conversion of current or voltage signal, such as temperature or pressure sensors.

For the recording of analog signals the analog to SSI conversion module AWA/SSI in 8 and 12 bit resolution is available for the CamCon. This module is connected to the SSI of the CamCon and is switched ON through the selection of the analog measuring system in the menu "Measuring system".

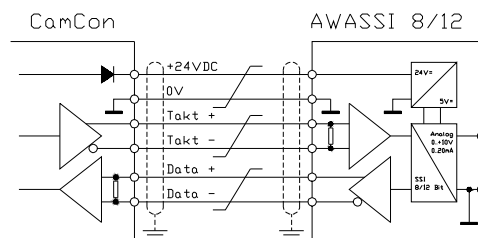

4.9.5. PLL measuring system input

Systems with Phase - Lock - Loop data recording. In these systems the actual value is found through interpolation of initiator impulses. This measuring system is applied to machines with constant speed and with a cyclic pulse.

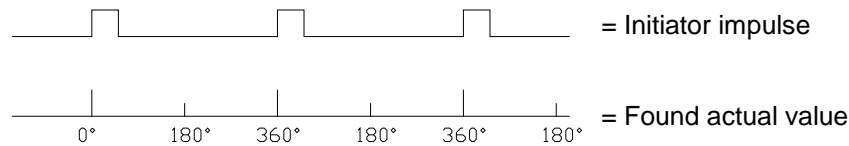

The Initiator can be connected to any free input of the CamCon.

Note: For CamCon DC115 a special input is available on the 25pol. SUB-D plug.

See also chapter "7.4.1.6.5. PLL measuring system" on page 53.

4.9.6. Timer as a measuring system

Systems which are controlled by elapsed time. In this case the CamCon makes a time available with a time basis of minimum 1 ms as actual value. Through laying on of input signals it is possible to influence the elapsed time. This measuring system is applied to machines with a fixed time scanner as a control feature, e.g. washing machines.

See also chapter "7.4.1.6.6. Timer way simulation" on page 53.

4.9.7. RS232 as a measuring system

Systems, receiving their actual position through the RS232 interface, e.g. for a junction of a Stegmann POMUX linear scale to a RS232 data output.



Warning The activation of this measuring system blocks the RS232 interface for programming. This measuring system is only reasonable with a CamCon DC50/51.

4.10. The outputs

The CamCon DC300 has 24 short circuit-proof outputs. They supply 24Volt high - active signals to the S7 BUS and are isolated. The +24V power supply of the output blocks 1-8, 9-16 and 17-24 are separate from one another for purposes of load sharing; consequently, each output block must be supplied from the outside with +24V. The outputs supply a constant current of 0.5A for each channel. Please read the chapter, "7.4.6.2. Setting the outputs" on page 65.

Please note: Outputs 17 - 24 share the terminals with the inputs 1 - 8.



Important: For inductive loads, the inductance must be wired with a recovery diode.

4.11. The inputs

The CamCon DC300 has 8 inputs. These inputs work with highly active 24V signals and are isolated from the S7 BUS.

Please note: The inputs 1 - 8 share the terminals with the outputs 17 -24.

The input wiring:

The input resistance is about 5.7 KOhm.

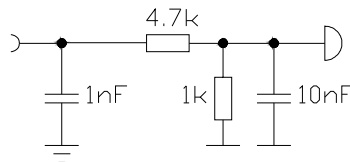

The inputs of the CamCon have not been covered with functions by the factory. The user would have to do this himself in the process of setting system data of the CamCon depending on his requirements. See chapter "7.4.6. System upgrading" on page 65, chapter "7.4.1. Measuring system" on page 47, chapter "7.4.6.7. Setting the external program selection" on page 66 and chapter "7.4.6.4. Setting the keyboard lock" on page 65.

4.12. Precautionary measures for welding work

Attention: For the duration of welding operations carried out at the machine, the connecting wires concerning the data exchange from the measuring system to the CamCon and the power supply as well as the grounding connections and inputs and outputs have to be separated from the CamCon.



4.13. Status displays

The CamCon DC300 has several status displays. These include: 24 output displays, 4 displays for power supply, one display for error messages and one display for the status of the internal peripheral equipment of the CamCon DC300.

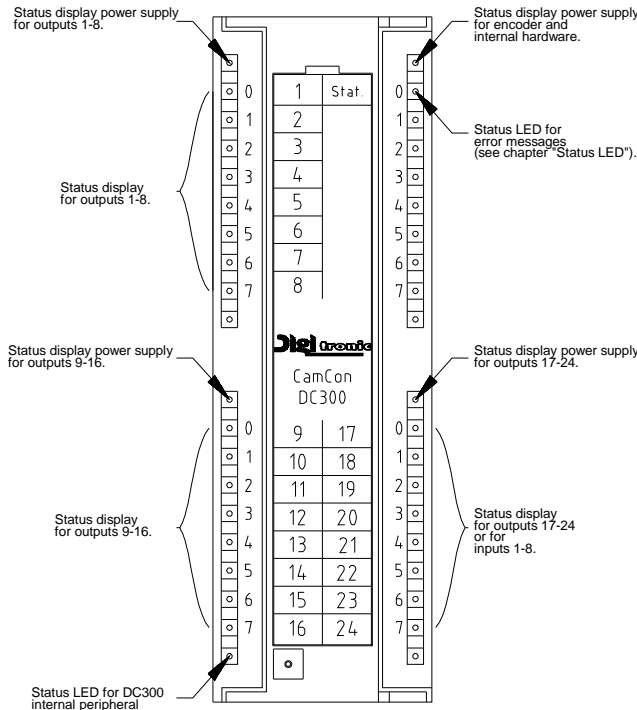

The status LED of the internal peripheral equipment indicates that the CPU is responding to the inputs and outputs. If this does not light up, there is an error message or a restart, or the DC300 cannot be started.

4.13.1. Status LED

The status LED of the CamCon shows the different blinking intervals of the the device state. This way, the operation state of the device can be seen without a PC or a terminal.

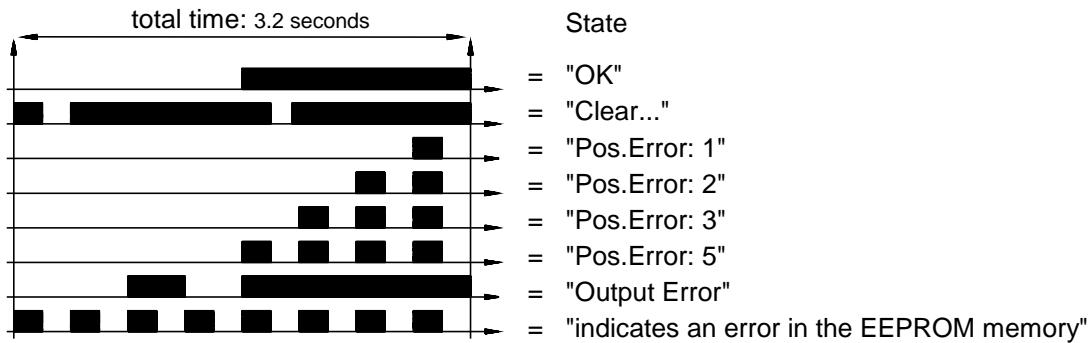

See also chapter "9. Error messages and removal of errors (FAQ)" on page 81.

5. General programming information















To program CamCon units without integrated input devices (CamCons DC16/90 and CamCon DC115) you can use any IBM or compatible PC as well as the DIGISOFT programmingset order number Best.Nr.: PC/SET/WIN. This set includes all necessary cables and an RS232-RS485 level-transformer (Comuca).

There is also the possibility to do the programming with a CamCon DC50/51 or a CamCon CT10 terminal. All of the following operations and functions have references to the inputs made with the PC software or the CamCon DC50/51 (CT10) terminal, i.e. the key commands of the PC or the CamCon DC50/51 terminal are transmitted to the CamCon unit via the serial interface. As a return, the display of the CamCon unit is sent to the PC or the CamCon DC50/51 terminal.



The programming through the S7 300 CPU is described in the chapter, "13. Communication between S7 and CamCon DC300" on page 88. The programming of the parameters and the cams is possible through the S7 BUS as well as through the serial interface. It therefore makes no difference whether the data is programmed through the serial interface or through the S7 CPU.

Note: Through the function block FB51 and its subcomponents FC52,53,54 and 55 of the S7, it is possible to program the CamCon DC300 without having to connect a PC or a CamCon terminal to the RS485 interface. However, the programming of the optional SPS logic module of the CamCon is still currently not included.







5.1. Outline of key functions

	cursor down
	cursor up
	cursor to the left, shifting cams
	cursor to the right, shifting cams
	choose cam activation point, character selection during text input, (or PC 'PageUp' key)
	choose cam deactivation point, character selection during text input (or PC 'PageDown' key)
	input of cams, special measuring systems, character during text input
	place holder for display formats, reset during error messages, special functions
	Escape: leaving the current menu, returning to the next higher menu
	deletion of cams, outputs, programs and single characters during text input
	deletion of single characters during text input
	confirm input and save data
	changes the algebraic sign during data input
	comma
	numeric keys for data input









5.2. Menu selection



You can select a desired menu by pressing the corresponding numeric key or by moving the cursor (the black beam) on the menu name with keys  and  and pressing the  key.







5.3. Selection of a menu point

The input in the single menus is subdivided into menu points. These are active (or selected), if the display is inverted. The selection of these menu points is made with keys , ,  and  and a confirmation of your choice with the  key. You can always cancel an input by pressing the  key. If you pressed a wrong key, the unit shows a hint of the keys you can use in this menu and their functions.

5.4. Text input

With menu points, in which texts have to be implemented, the  and  keys function together with the  and  keys like a coordinate control. You select the desired position for the first character, using the  and  keys. Then you can choose the character with the  and  keys, by going up and down through the alphabet or the ASCII characters. If you move the cursor to the right with the  key, character entered prior to this will appear in the new position of the cursor, simplifying making repeated inputs of the same character.

If you have made an error you can go back to the wrong character to correct it, using the  key or the  key. This will cause the other characters to become erased. To abandon the input press the  key.

Attention: The software for the text input at the CamCon has changed since EPROMS of 1/97. The selection of desired characters is now realized with keys  and . With keys  and  you can now position the cursor anywhere in the previously entered text. You can overwrite characters, insert characters by pressing the  key or delete characters with keys  or .

Note: The text input is also possible directly via PC.

6. Initial Operation

After the assembly and before switching on for the first time, check the wiring of the device. Please see Chapter "4. Electrical connections" on page 16.

Note: For inductive loads, the outputs must be wired with a recovery diode.



After switching on the power supply on the S7 sub-rack, the device responds through a short flickering of the LED status (Stat.). Afterwards, the internal examination and startup of the system follows (e.g., the check sum of the EEPROMs and of the EPROMs is determined). This requires a few seconds. After terminating this process, the S7 BUS is initialized. The S7 CPU waits independently (up to 65 seconds, adjustable in the hardware definition of the S7 CPU) in the STOP state until this initialization process of the DC300 is completed.

After first activating the supply voltage, the program memory is not in a defined state. So when first using the CamCon unit you have to put a complete deletion into operation as follows:

1. Press the **ESC** key, you leave the standard display and enter the main menu:
2. Select the menu point "Unit configuration", the request to enter your user code is displayed on the LCD:

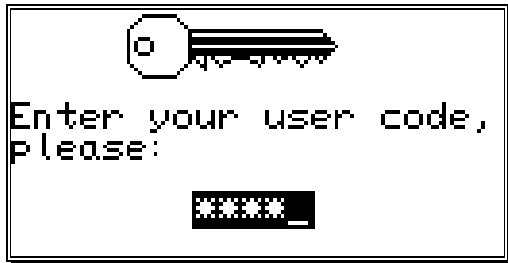
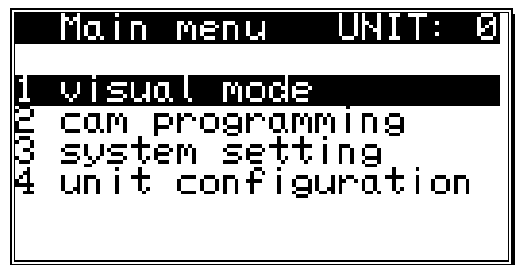

3. Enter your user code. If you have not programmed your own key, use the standard key number "5693"!

4. Press the **CR** key to confirm your user code. If a false code is entered, "Wrong user code!" is shown on the display. In this case, press any key, and reenter the code. The display returns to the main menu after about 30 sec., if no numbers are entered or the input is not confirmed with the **CR** key.

After the correct user code is entered, the display shows the configuration menu.

5. Select the menu point "Format unit", the following question is displayed:

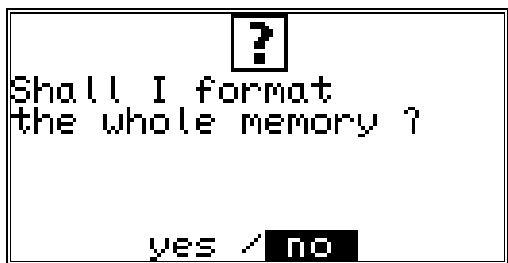
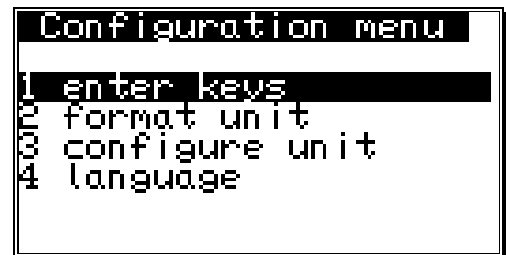

6. Move the cursor to "yes" with the **←** key.
7. Press the **CR** key.

After about 5 sec. the display returns to the configuration menu. This waiting time depends on the size of the used EEPROM, since the memory has to be formatted. With the use of a 32k - EEPROM it is increased to approximately 2 min. After this time the complete deletion is finished. All cams are erased, all system registers have the standard value.

Now you can begin with the system setting.

To make your device operable, you have to set a minimum number of parameters on your CamCon. This is the recommended order of the parameterization. You can find the necessary information in the corresponding chapters.

- 1) System setting, System upgrading See chapter "7.4.6. System upgrading" on page 65.
- 2) System setting, Cable length See chapter "7.4.4.1. The cable length" on page 61.
- 3) System setting, Measuring system See chapter "7.4.1. Measuring system" on page 47.
- 4) Unit configuration, hardware configuration, See chapter "7.5.6. Configure Hardware" on page 77.

If you have adjusted the inputs according to the corresponding chapters, the CamCon is ready and no more error messages should occur. Of course we recommend to go through the whole system setting menu to receive a maximum of user ability and comfort.

After the system setting you can begin with the cam programming.

6.1. Projecting the S7 CPU for CamCon DC300

For the process described in the previous chapter for deleting and parameterizing the CamCon subassembly, a PC with RS485 interface must first be connected. However, this can be omitted if the data is programmed through the S7 communication program. For this purpose, the CamCon DC300 with the S7 hardware configuration must first be inserted into the configuration table of the S7 CPU.

Start the the S7 software and open the project you want. Open the file Hardware, and afterwards, the hardware catalogue. In the hardware catalogue, select the menu item "S7 300" and open it by double-clicking on it. From the heading FM300, select "FM352 CAM MODULE", order number: 6ES7 352-1AH00-0AE0, and insert this into the sub-rack of your CPU. In this case, the assembly or card slot of the DC300 must be noted (see also the manual of your S7 CPU). The CamCon DC300 displays an analog representation of the subassembly for the S7 300 CPU; this always requires a 16-byte peripheral range. If you installed the DC300 directly to the right of the S7 CPU on the support, the FM352 module must be filed in line 4 and the base address is at 256. The further to the right the card slot of the DC300 is in the BUS, the further up in the table the module must be filed and the higher the base address. You must now open the subassembly by double-clicking on the appropriate line. Note this address for future input in the parameter "ADR" when invoking the FB51 and FC51 of the communication software. The input and output addresses must always be the same. If you transferred the hardware table to your S7 CPU, there should no longer be any error messages on the CPU.

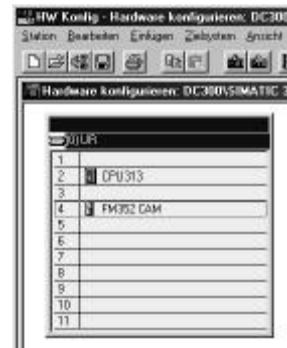

Note: Starting with version 6 of the DC300 software, the IM153 of the ET200M series will also be supported. Here, the "FM352 CAM MODULE" will also be inserted into the decentralized sub-rack as a hardware component. Please regard that the Cam outputs 33 - 48 can not be enabled via the S7 in the IM153. For this purpose switch off the enabling function by switching on the CamCon's PLC-Logic-module.

After the successful configuration, the communication software must now be inserted into your project and be parameterized. In this regard, please see the chapter 13. "Communication between S7 and CamCon DC300" on page 88.

7. Operation of the CamCon

7.1. The main menu

The programming always starts at the main menu. No matter in which state of programming you are, you can always reach the main menu by pressing the **ESC** key (several times, if necessary).

By pressing the corresponding number or by selection with keys **▼** and **▲** and a verification with the **CR** key, you can enter the submenus.

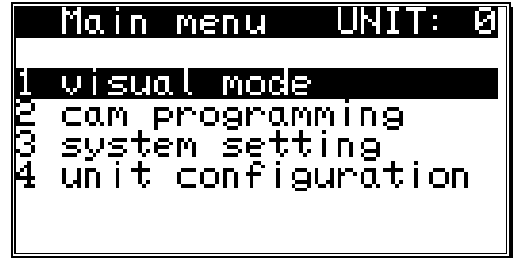

7.2. The standard display

You reach the submenu for the display for normal operation of the cam controller via the main menu point "Visual mode" or by pressing the **ESC** key (at the main menu).

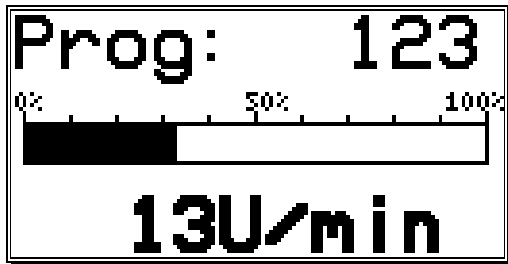

In the display menu, the active program number, the relative speed as a bar (e.g. for an analog speed output) and the current actual position, respectively the absolute speed (with higher rotational numbers), are displayed. If the measuring system is put into a slow motion the respective actual position is shown on the display. With increasing rotation velocity the device switches at a defined point (5%) to a display showing the current speed in the desired representation; a negative direction in the rotation is shown through a negative sign in front of the

displayed value.

The configuration of the speed display is done in the system setting menu. Here you can e.g. disable the automatic change of the display, by selecting a certain display type (see chapter "7.4.3. The speed adjustment" on page 59).

7.2.1. Changing the display

If you want to receive status information of in- and outputs during operation, you can switch through the several status displays, using keys **◀** and **▶**. The display then shows an outline of operation for inputs and outputs:

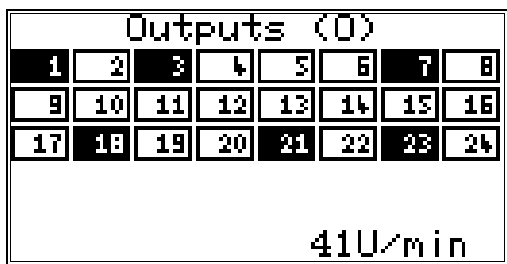

Output display

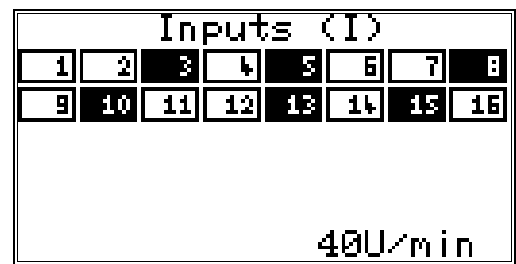

Input display

As soon as an in- or output activates, its field on the display turns black.

In the lower righthand corner of the display, you can see the current position or the absolute speed at a faster movement.

7.2.2. Program change

With the CamCon you are capable of storing several programs. To choose one of these programs you have to be in the standard display. The selection of a desired program is done as follows:

1. Press the **CR** key, the display shows the request for your user code.
2. Enter your user code.
3. Press the **CR** key, the cursor goes to the menu field of the program number.

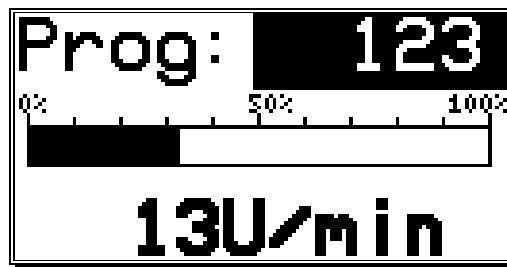

4. Enter program number with the numeric keys
5. Press the **CR** key to complete your input

The CamCon will change programs according to the program selection parameters you entered. If the process takes longer than one second, the display will blink until the selection is complete see chapter "7.4.6.8. Setting the program selection mode" on page 66.

7.2.3. Program name

With the CamCon you can assign a text to the stored programs. This is recommended when important information needs to be linked to the program number (e.g. a toolnumber or the name of a product). The input of the program name is done as follows:

1. Press the **CR** key, the display shows the request for your user code
2. Enter your user code
3. Press the **CR** key, the cursor goes to the menu field of the program number
4. Press the **#** key, the cursor goes to the text input of the program number

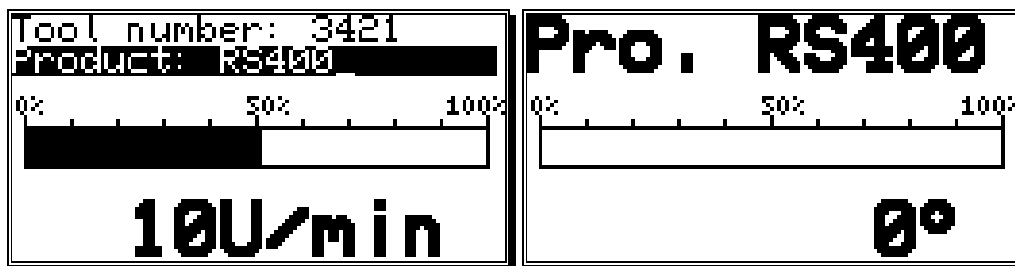

Here you can enter a name for your program (see chapter "5.4. Text input" on page 29).

5. Confirm your input with the **CR** key

The presentation of the program name changes with the length of the input text. 2 lines with 21 characters each or 1 line with 10 characters can be displayed.

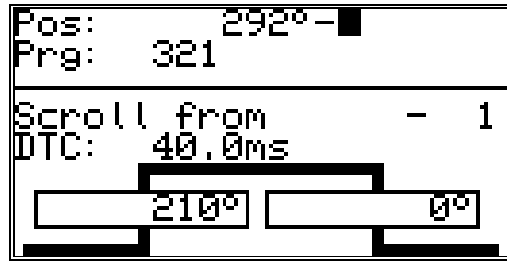

7.3. Cam programming

To get to the actual cam programming select "**Cam programming**" in the main menu. The display switches to the programming menu:





The upper part shows the current actual position, the switched state of the selected output and the chosen program. The lower part displays an output with programmed cams and their activation and their deactivation points. If no input is made within two minutes the CamCon automatically returns to the main menu for reasons of safety.

7.3.1. Output selection for programming

You can select the desired output by pressing the  and  keys.

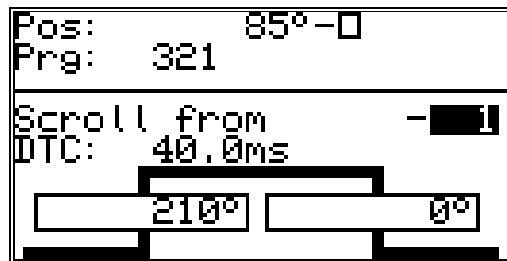
By pressing the  key you reach the direct input of the output number.



With the numeric keys you can select the number of the output you want to select. Confirm your selection with the  key.

7.3.2. Program selection for programming

You reach the input of the output number by pressing the **CR** key. You skip this by pressing the **▲** key and enter the program selection for the programming.

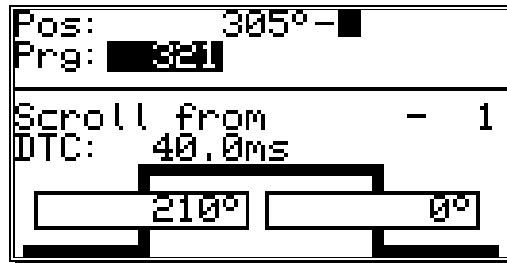

Enter the number of the desired program by using the numeric keys. Confirm your input with the **CR** key.



A change in the program number does not lead to a change in the momentarily active cam program. This means: You can program a program while another program operates the outputs.

7.3.3. Programming the delay time/speed compensation

You reach the input of the output number by pressing the **CR** key. You skip this by pressing the **▼** key and enter the delay time you want to compensate.

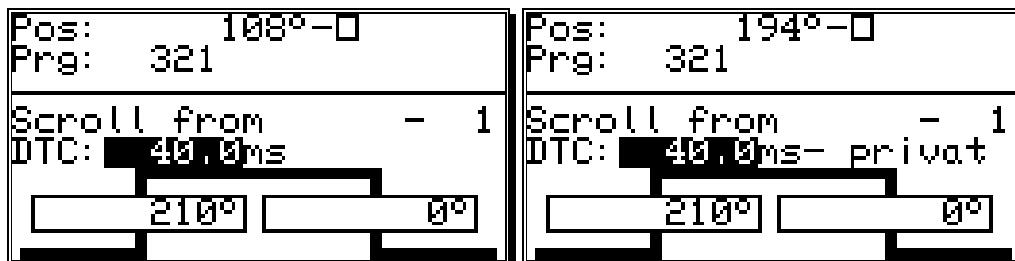

With the numeric keys you can enter the delay time that you need to compensate.

By pressing the **▼** key while entering, the effects of the speed compensation for the switch-on- and switch-off-point will be switched separately and the second delay time value can be fed in.

This separated speed compensation can be deleted by pressing **DEL** while entering the second delay time value.

Attention:

If the offswitchpoint overtakes the onswitchpoint at rising speed, the result will be a non-defined signal.

By pressing the **#** key with the input you can limit the effect of the delay time to the program you are programming (private). A renewed pressing of the **#** key takes on the standard speed compensation for this program.

Confirm your input by pressing the **CR** key.

References to the way speed compensation works can be found in chapter "2.1. Speed Compensation" on page 9.

7.3.4. Programing Time-Cams

By pressing **CR** you get to enter the starting number, which can be adopted by confirming with key **▼**. After that, you are put forward to entering the delay time.

Attention: When programing a Cam, the specific output must have a switched speed compensation. Also see chapter "7.4.6.3. Setting the outputs with speed compensation" on page 65.

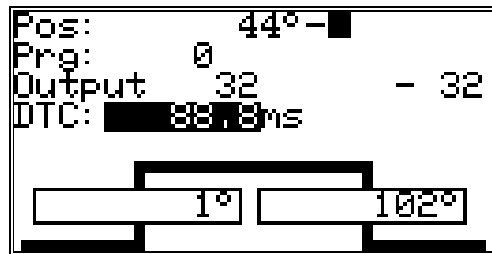

Using the numeric keys you can enter the delay time. Press while entering followed by pressing to switch on your way-Cam, so that you are able to enter the switching time in steps of 0.1 ms.

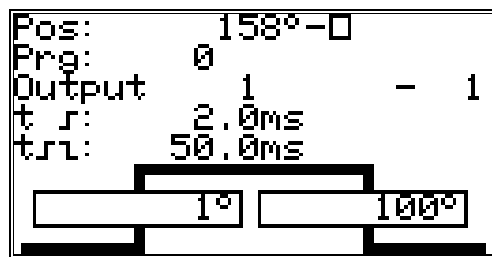

Pressing **DEL** while entering the switching time will switch of the Cam.

Attention:

If the next Cam switching point reaches a Cam that is not yet switched off, both Cams will be summed up as one.

Pressing **#** while entering delay time or switching-time values can limit the effects of these values on the program that is worked on (private). A second **#** key will switch off the private input. This function can be switched on or off separately for delay- and switching time.

A **CR** key will confirm these values and quit the input-section.

7.3.5. Programming the output name

You reach the input of the output number by pressing the **CR** key. You skip this by pressing the **◀** key and enter the input of the output name of this output.

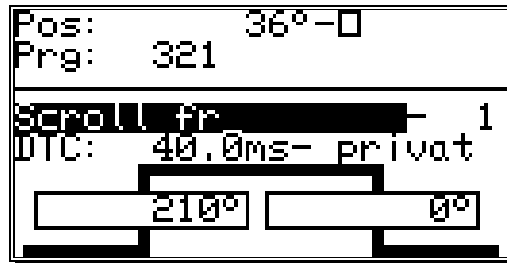

Here you can enter the output name via text input see chapter "5.4. Text input" on page 29.

7.3.6. Cam Input

By pressing the **↵** key you start the input of a cam. On the display the field for the cam activation point (left bar) is underlined in black, while a stylized cam blinks in the range of the two bars. With the numeric keys you enter the position for the cam activation point.

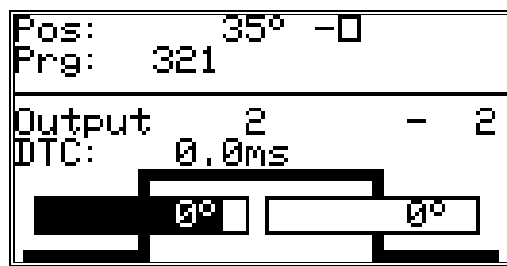

After you confirm your selection with the **CR** key, the field for the cam deactivation point is underlined in black. Simultaneously, the dropping flank of the stylized cam starts to blink.

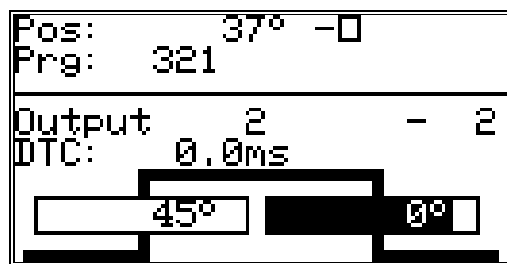

Enter the value for the cam deactivation point with the numeric keys and finish your input with the pressing of the **CR** key.

Remember: The maximum expansion of a cam can never reach a full rotation. For the programming of such a cam you have to program a security output (see chapter "7.4.5. The special outputs" on page 61).

7.3.7. Adding cams

In case you want to program additional cams on this output, you have to use the **INS** key. When you press this key the following is displayed on the display:

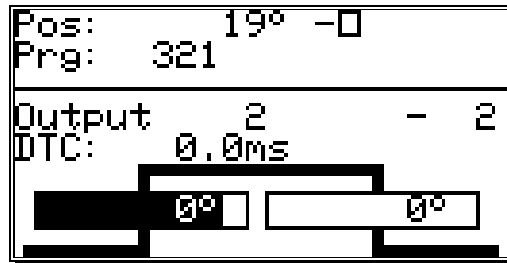

Here you can enter the positions for the activation and the deactivation point for the cam, as is described in the chapter "7.3.6. Cam Input". If you enter a cam that overlaps with an already existing cam, you create a single, greater cam.

Example: The previously configured cam lies between 50 and 120 degrees. If you now create a new cam between 90 and 180 degrees, these two cams are combined into a new cam from 50 to 180 degrees.

7.3.8. Cam Teach - In

If you are in an input field of an activation or deactivation point during cam programming, you can assume the current actual position for the field by pressing the **#** key. The actual position is displayed and brought up to date until the **J**, **L**, **CR** or **ESC** key is pressed to confirm the value or to abort the input.

7.3.9. Cam Search

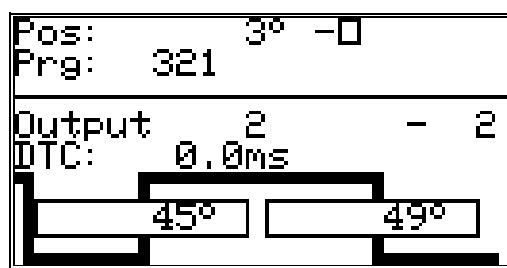

With the **◀** and **▶** keys you can call up and control the programmed cams. With each activation a single cam is displayed, and its neighbouring cams are shown as their flanks on the edges of the display.





The increasing course of the cam curvature on the right edge of the display points to another cam that is positioned between the cam deactivation point (180°) and the higher border of the measurement range (e.g.:359°). The left flank hints to the presence of additional cams between the cam activation point (45°) and the lower border of the measurement range (e.g.:0°).

With the **◀** and **▶** keys you can determine whether there are other programmed cams.

7.3.10. Cam deletion

If you want to completely erase a cam, select the cam using the  and  keys and press the  key, causing the following question to be displayed:



To delete the cam, move the cursor to "yes" with the  key, and press the  key to confirm your choice.

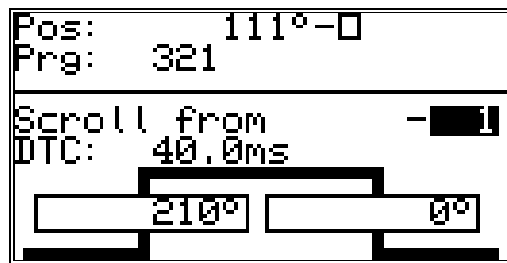

7.3.11. Output (cam track) deletion

If you want to completely erase an output (cam track), you have to press the  key to enter the input of the output number.

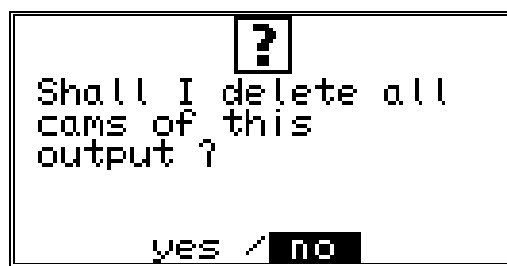

Now you can enter the number of the output you want to delete with the numeric keys. Press the  key and the following question is displayed:



Move the cursor to "yes" with the  key and press the  key to confirm your input.

7.3.12. Copying programmed outputs (cam tracks)

With the CamCon you have the option to copy all the cams you have programmed on one output to additional outputs. First press the **CR** key to enter the input of the output number. Select the output that you want to copy to the previous selected output with the numeric keys. Press the **#** key to start the copying process. The following question is displayed:

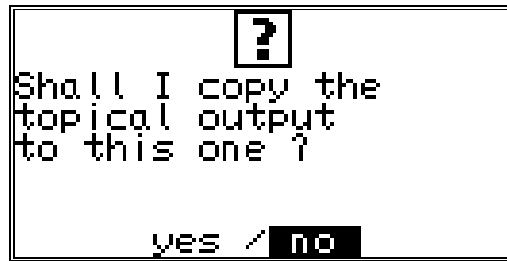

Move the cursor to "yes" with the **←** key and press the **CR** key to confirm your input. This starts the copying process. After a short while the new output will appear on the display.

7.3.13. Shifting cam tracks

With the CamCon you have the option to shift all the programmed cams of one output, using the **←** and the **→** key.

Press the **↵** or the **↵** key to enter the input of the activation or the deactivation point.

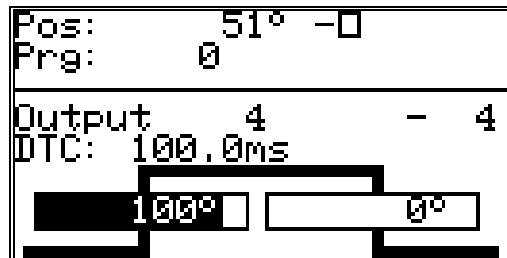

If you now press the **←** key or the **→** key, all the cams of this output are shifted by one increment. In this case the cams are directly taken over into the memory without the use of the **CR** key (unlike before). The shifting process is ended by pressing either the **CR** key or the **ESC** key.

7.3.14. Deleting programs

If you want to erase a whole program, you have to press the **CR** key to enter the input of the output number. Skip it by pressing the **▲** key, and you enter the program selection for programming.

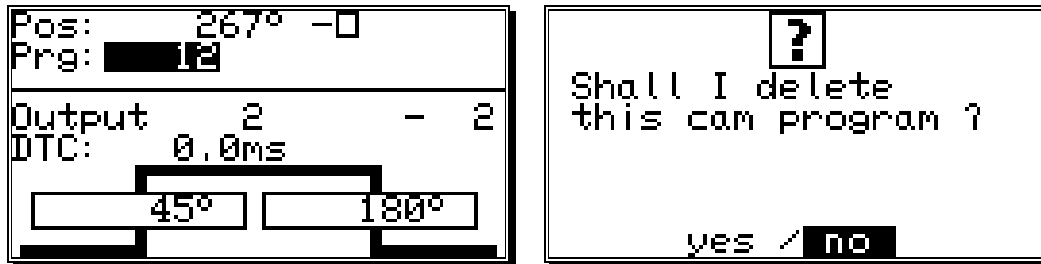

Enter the number of the program that you want to delete with the numeric keys. Press **DEL** and the display shows the security precaution question for the deletion of programs. Move the cursor to "yes" with the **◀** key, and press the **CR** key to delete the program.

7.3.15. Copying programs

With the CamCon you also copy whole programs. This is done as follows:

1. Press the **CR** key, the cursor moves to the input of the output number.
2. Press the **▲** key, the cursor moves to the input of the program number.
3. Select the program you want to copy using the numeric keys.
4. Press the **CR** key to confirm your selection.
5. Press the **CR** key, the cursor moves to the input of the output number.
6. Press the **▲** key, the cursor moves to the input of the program number.
7. Using the numeric keys, select the program onto which you want to copy the previously selected program.
8. Press the **#** key, to start the copying process. The display shows the question:

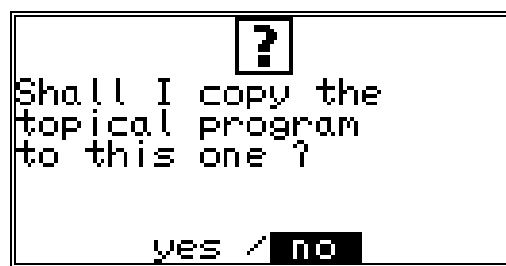

9. Move the cursor to "yes" with the **◀** key and press the **CR** key to confirm your input.

This finally initializes the copying process, and after a short while the new program appears on the display.

7.3.16. Examples for cam programming

7.3.16.1. First cam programming

Task: After a complete deletion of the program memory and a successful initialization of the system, a cam shall be programmed for output 4 from 100° to 200° with a speed compensation of 100ms

```
Pos: 123° -■
Prg: 0

Output 1 - 1
DTC: 0.0ms

-----
```

```
Pos: 231° -□
Prg: 0

Output 1 - ■
DTC: 0.0ms

-----
```

```
Pos: 51° -□
Prg: 0

Output 4 - 4
DTC: 100.0ms

-----
```

```
Pos: 51° -□
Prg: 0

Output 4 - 4
DTC: 100.0ms

100° □ □°
```

```
Pos: 183° -□
Prg: 0

Output 4 - 4
DTC: 100.0ms

100° □ 200° □
```

```
Pos: 185° -■
Prg: 0

Output 4 - 4
DTC: 100.0ms

100° □ 200° □
```

Solution:

1. Choose the main menu point "Programming".
2. Enter your user code and press the **CR** key, to have the programming menu displayed.
3. Press the **CR** key and enter "4".
4. Press the **▼** key, the cursor moves to the field for speed compensation.
5. Enter the value "1000" with the numeric keys.
6. Press the **↵** key to enter the cam activation point. The cursor moves to the input field for the cam activation point. Simultaneously, a stylized cam starts blinking.
7. Enter the value "100" for the cam activation point with the numeric keys.
8. Press the **↵** key. The cursor moves to the input field for the cam deactivation point.
9. Enter the value "200" for the cam deactivation point with the numeric keys.
10. Press the **CR** key to confirm your input. The first cam is now programmed.
11. You can leave this menu any time by pressing the **ESC** key.

7.3.16.2. Programming additional cams on an output

Task: Program an additional cam from 300° to 330° in program 0, on output 4 with the cam from 100° to 200°.

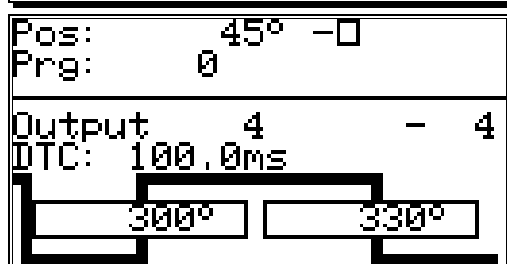
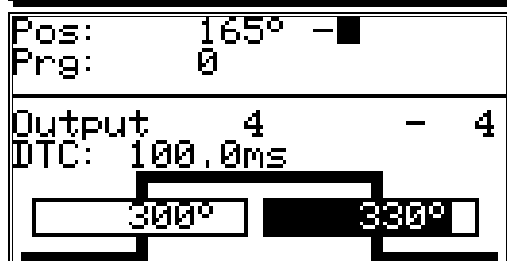
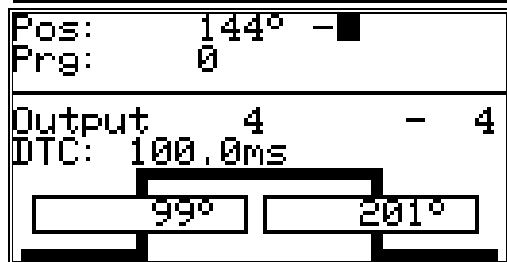
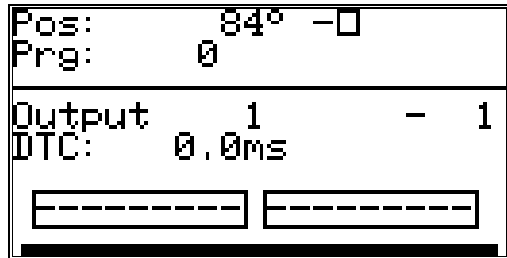

Solution

1. Select the menu point "programming" in the main menu.
2. Enter your user code and press the **CR** key. The programming menu is displayed:
3. Select output 4 with the **▲** key or press **CR**, enter "4" and press the **CR** key again.
4. Press the **INS** key to enter the cam activation point for an additional cam. The cursor moves to the input field for the cam activation point; a stylized cam starts to blink simultaneously.
5. Enter the value "300" for the cam activation point by using the numeric keys.
6. Press the **L** or the **CR** key. The cursor moves to the input field for the cam deactivation point.
7. Enter the value "330" for the cam deactivation point by using the numeric keys.
8. Press the **CR** key to confirm your input. The second cam is programmed.

The display shows the newly programmed cam as well as the cam between 100° and 200° as a flank on the left edge of the display.

9. You can leave this menu at any time by pressing the **ESC** key.

7.3.16.3. Deletion of a particular cam

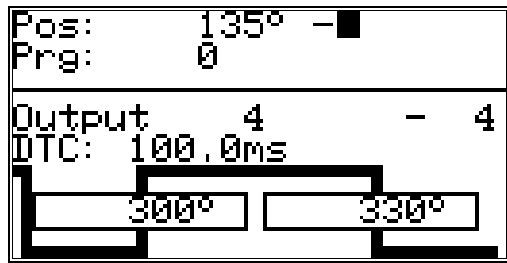
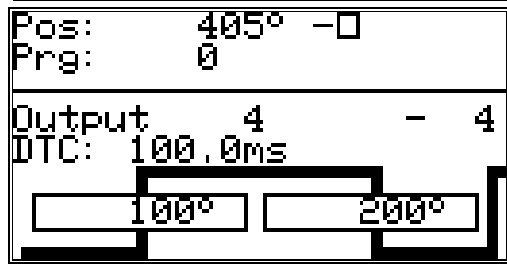
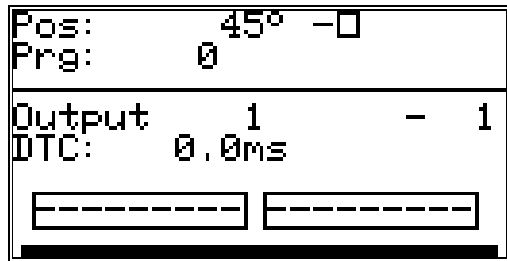

Task: In program 0 the inserted cam between 300° and 330° shall be erased.



Solution:

1. Select the menu point "cam programming" in the main menu.
2. Enter your user code and press the **CR** key. The programming menu is displayed.
3. Select output 4 with the **▲** key or press **CR**, enter "4" and press the **CR** key again.
4. Select the inserted cam with the **▶** key.
5. Press the **DEL** key. The display shows the following question:
6. Using the **◀** key, move the cursor to "yes".
7. Press the **CR** key to confirm your input. The cam between 300° and 330° is erased.

7.3.17. Programming analog cams

If your CamCon is equipped with analog outputs, and you have activated the option of analog cams (see chapter "7.4.5.7. Configuration of the analog cams" on page 63), the last "normal" output will be displayed as the first analog output after pressing the . If several analog outputs are programmed, you can choose the next output number by pressing the  key.

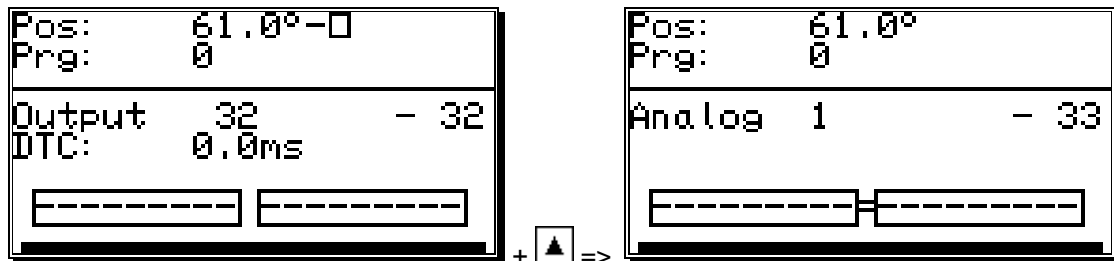

The output numbers of the analog cam outputs are always added to the numbers of "normal" outputs and this number can be selected directly from the programming menu. If you have configured e.g. 32 cam outputs, the number of the first analog cam starts at the output 33. The output number of the analog cam changes automatically when you change the number of "normal" outputs (see chapter "7.4.6.2. Setting the outputs" on page 65).

The programming of the analog cam is **mostly** done as described in the chapters for "normal" cam programming (see chapter "7.3. Cam programming"). For analog outputs, you do not program a position as a deactivation point, but an analog value. If several such values are programmed at different positions and the measuring system starts to move, CamCon controls the analog output in such a fashion, that a curve is done, corresponding with the drawing below.

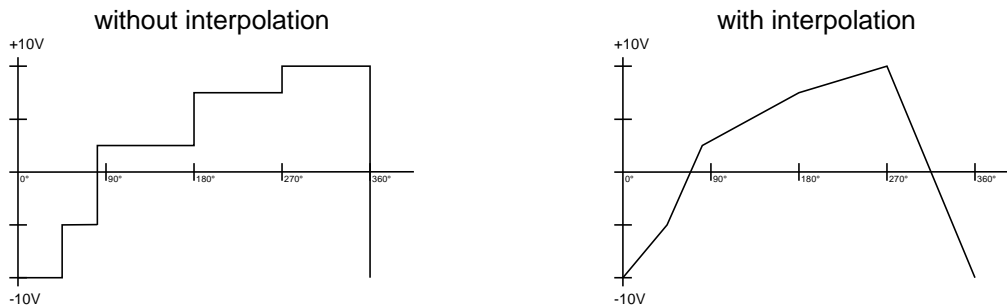

Through interpolation of the definition points, CamCon can adjust the values and present a curve, corresponding to the above right drawing.

7.3.17.1. Creating the first analog cam

To program your first analog cam, choose the program and the desired output for programming (see chapters: "7.3.2. Program selection for programming" and "7.3.1. Output selection for programming"). Press the **↓** key and enter the position value for the first definition point. Now press the **CR**, enter the analog value and confirm your input with the **CR** key.

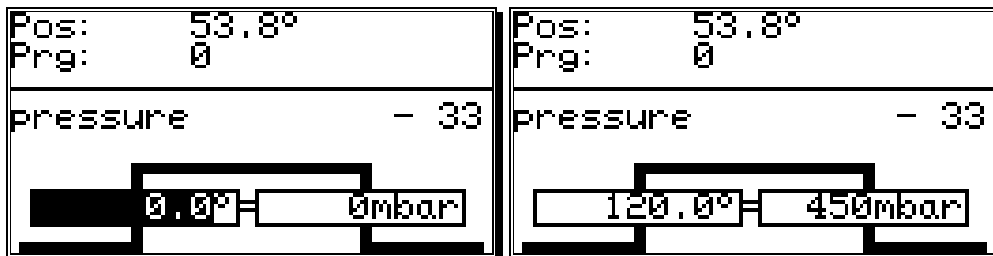

Note: As long as only one cam is programmed on a cam track, the programmed analog value is emitted for the whole way of the measuring system.

7.3.17.2. Adding an analog cam

To add another definition point, choose a desired output, press the **INS** key and enter a new position value. Press the key **CR**, enter the analog value and confirm your input with the **CR** key.

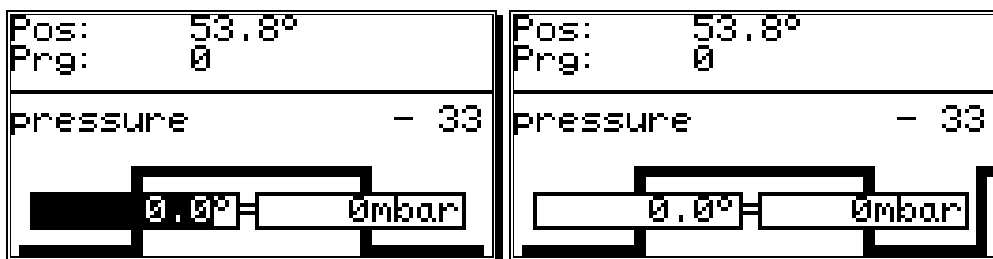

Further cams are added with the same procedure.

7.3.17.3. Changing the analog cam

To change or delete an analog cam, proceed as described in chapters "7.3.9. Cam Search", "7.3.10. Cam deletion" and "7.3.11. Output (cam track) deletion".

Note: The programming of a delay time, the copying of an analog cam track and the shifting of the complete cam track is not possible at the time.

7.4. Unit configuration (system setting)

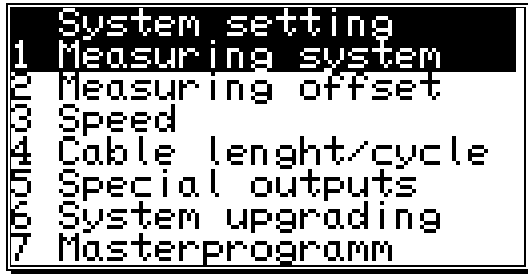

Before you are able to use this device, you have to give it all the information about the parameters of your measuring system. Select the menu point "**System setting**" in the main menu. The display shows the system setting menu:

7.4.1. Measuring system

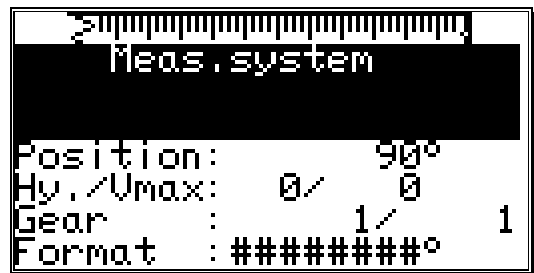

When you select the menu point "**Measuring system**", the display changes to the measuring system menu:

Here you can configure the measuring system, the resolution, the electronic gear, the actual position hysteresis, the rotation direction and the display format of the actual position, as well as a special measuring system. Additionally, the menu point "**Position:**" always shows the actual position of the CamCon. See also chapter "4.9. The measuring system" on page 21.

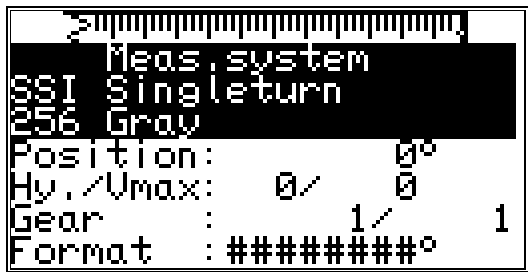

7.4.1.1. The standard measuring systems



The display gives the resolution of the measuring system in steps per rotation. Generally the CamCon works with a rotation angle coder that has a resolution of 360 steps per rotation. In this case a change in the input value is superfluous. Otherwise the CamCon can be adjusted to the measuring system with the  and  keys. You can choose between the following predefined resolutions, that are all in accordance with common rotation encoders: 256, 360, 512, 1000, 1024,

2048, 4096 and 8192 steps. Should you not be able to set values in higher resolution ranges, it is because there is not enough memory available. If this is the case you have to extend the memory of the device. Also, you can configure two analog SSI changer modules, AWA/SSI/8 and AWA/SSI/12, for the gathering of analog signals. These modules are connected to the SSI port of the CamCon.

Note: Should you not be able to set values in higher resolution ranges, it is because there is not enough memory available. You will need to upgrade the memory of your device. See also chapter "12. Calculation the RAM storage-requirement for" on page 87.

7.4.1.2. The actual position hysteresis

At the menu point "**Hyst.**" you enter the actual position hysteresis.

This value is needed to suppress the flashing of the outputs during uneven data gathering. The exact value can only be determined through experiments, though it should be as small as possible or always "0". The hysteresis can be between 0 and 1/4th of the total resolution, but can never exceed 255 impulses.

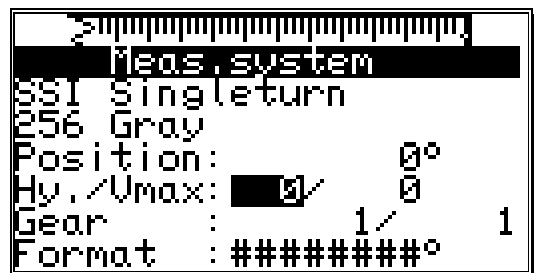

7.4.1.3. Controlling the measuring system

The option "Vmax" of the menu enables entering the tolerated steps per cycle of the actual value.. This enables controlling a measure-system.

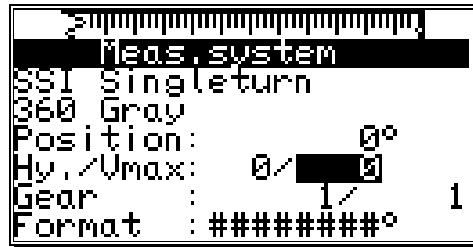

The required value is calculated of the CamCon's actual cycle-time, the measuring system's physical resolution and the device's Speed.

Note: The resolution needs to be a physical measure, e.g. if for a measuring system 4096 Impulses are calculated to 3600 by a (3600/4096)gear, the resolution must be set to 4096.

Example: Cycle time = 0.5ms / resolution = 360 / speed of machine = 180 min⁻¹.

$$\text{Value} = \frac{\text{resolution} * \text{plant speed}}{60 * 1000} * \text{Cycle time} + \text{margin}$$

$$\frac{360 * 180}{60 * 1000} * 0.5 + 5 = 5.54 \approx 6$$

The result is rounded and filled in "**Vmax**"

If the CamCon detects a step of more than 6 impulses at the actual value an error report "**Ist-Err:5**" is shown.

If a zero is filled in here, the controll is deactivated, and a maximum of 9999 is possible.

7.4.1.4. The electronic gear

In the menu point "**Measuring system**" a factor for a measuring range transformation can be entered. Through this the physical measuring range e.g. of a rotation encoder is transformed into a new, for the user effective visible measuring range. Generally this transformation has the relation 1:1. The first value represents the multiplier of the actual position, while the second value stands for the divisor through which the result of the previous multiplication is divided. The result of this operation is the display value. A negative value in the field of the multiplier changes the direction of the rotation of the measuring system. To switch the algebraic sign press the \pm key during the input of the multiplier.

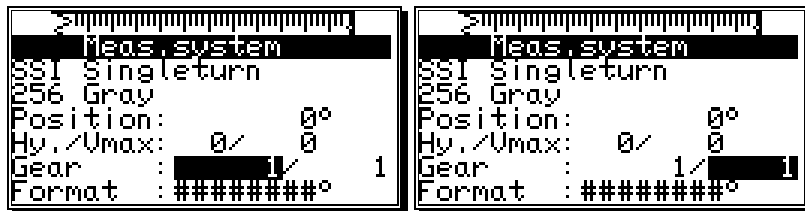

Example: At a full rotation of a rotation encoder with 360 steps per rotation a machine proceeds for 1000mm. If the display of the position is to be shown in mm rather than in angular lines, you have to reset the gear with the factor **1000 / 360**. The display will no longer change in single steps, since the resolution remains unaffected. If you choose e.g. **100 / 360**, the actual position is calculated down to a proceeding range of 100. The position display is carried out in cm, but a floating point representation is not possible.

7.4.1.4.1. Electronically changing the rotation direction

The direction of the rotation of the measuring system is set at the multiplier of the electronic gear by changing its algebraic sign. Press the \pm key during the input of the multiplier. See the chapter "7.4.1.4. The electronic gear".

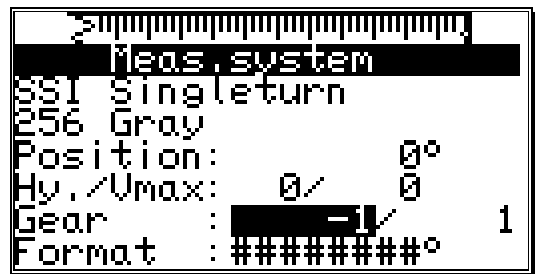

7.4.1.5. The display format of the actual position

In this menu point you can set the format for the display of the actual position.

The three # are the place holders for the number value of the display. You can enter additional comments and the unit of the measured value, e.g. mm, cm or inch with linear systems. See chapter "5.4. Text input" on page 29. If you want to display a decimal point, you can insert one between the place holders (e.g.: ###.#mm).

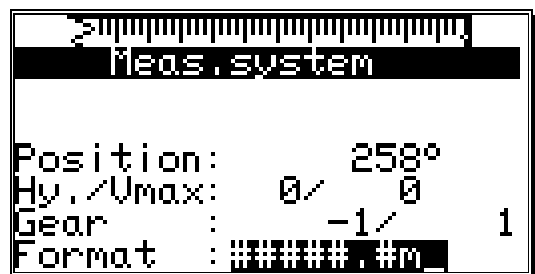

7.4.1.6. Configuration of a special measuring system

You have the possibility with CamCon to configure a special measuring system, according to the following steps:

1. To configure the special measuring system press the **INS** key. The menu for the input of a new measuring system appears on the the display.
2. Enter the measuring system description. See chapter "5.4. Text input" on page 29.
3. Presss the **CR** key to end the input of the first line. The cursor moves to the next line.
4. Enter additional text (if desired).
5. Press the **CR** key to end the text input. The cursor moves to the next menu point, "**Measuring system**".
6. Select the type of the measuring system with the **◀** and **▶** keys.
7. Press the **CR** key to confirm your input. Now the menu for the measuring system chosen by you is created. The following chapters discribe the different measuring systems and their settings.

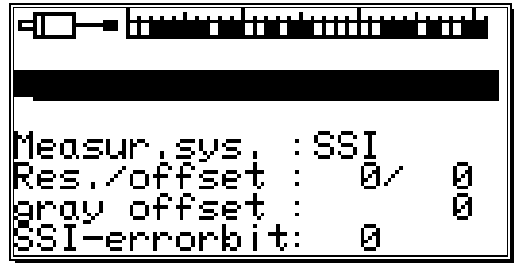

7.4.1.6.1. SSI - measuring system

If you selected "**SSI**" for your special measuring system in the measuring system input, the following menu is created:

1. Enter the bit number of the resolution of the SSI measuring system
A resolution of e.g. 500 impulses corresponds with 9 bits.
2. Now enter the position of the lowest-situated bit (LSB).
In our example the LSB would be on 9th position. You can get more specific information from the manufacturer of your measuring system.
3. Now enter the cut of the measuring system code.
In our example this would be $(512 - 500) / 2 = 6$.
4. Finally you have to enter the position of the SSI - errorbit of the measuring system. With standard rotation encoders of the firm Stegmann this position is 14. Always transfer a 0 to this position.
5. Press the **CR** key to confirm your inputs and exit this menu.

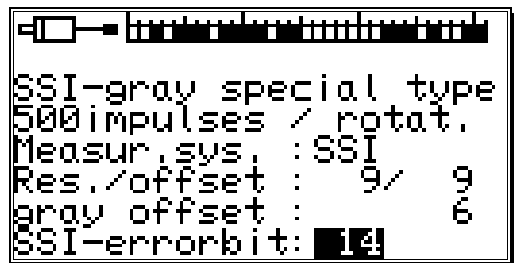

Attention: *The position of the data bits can be seen in the graphic in the upper part of the display. You can determine the positions of the LSB, HSB and errorbits quite easily by moving the measuring system.*

7.4.1.6.2. Parallel - Gray measuring system

If you selected "PARAL." for your special measuring system in the measuring system input, the following menu is created:



1. Enter the resolution of the parallel gray measuring system.
Here e.g. 500 impulses.
2. Now declare the input of the lowest-situated bit (LSB).

In our example the position of the LSB would be at input 7. With a resolution of 500 impulses 9 bits of resolution are needed. The CamCon automatically determines the position of the remaining inputs once it knows the position of the LSB; they are determined in increasing order. In our example inputs 7 to 16 would be allocated with the bits of the rotation encoder.

3. With **Mode** you can choose the encoding of an parallel measure system by pressing and : you can choose between **Gray** = Gracode and **Bin.** = Binarycode zur Verfügung.

Attention: Parallel binary encodings shall only be used as an exception. Please implicitly contact your custoimers service.

4. Press the key to confirm your inputs and exit this menu.

7.4.1.6.3. Incremental - measuring system

If you selected "INC" for your special measuring system in the measuring system input, the following menu is created:

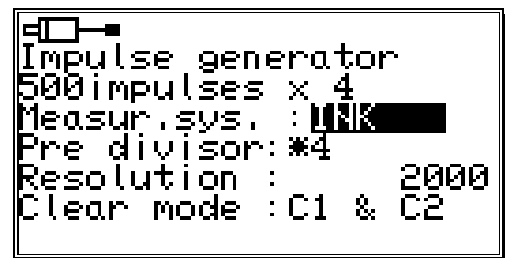

1. Enter the value of the prescaler (predivisor) with the and keys. The prescaler divides or multiplies the incoming impulses from the measuring system with the defined value. The following scalers can be entered: "*4", "*2", "*1", "/2", "/4", "/8", "/16", "/32", "/64", "/128", "/256", "/512".

Here the prescaler is set to "*4". This means that a measuring system with a resolution of 500 impulses supplies the device with 2000 impulses.

2. Now you enter in the field of the resolution the maximum number of needed impulses. This value is the maximum resolution, that can be evaluated by the CamCon. If more impulses than this maximum resolution are counted, the CamCon reports the error message "Pos Err:3". In this case the maximum resolution has to be reset with a higher value or the actual position has to be set to zero through a clear signal.

3. In the field "**Clear mode**" you set the functions for the two extra inputs C1 and C2 with the and the key. Here you have the choice between eight possible functions.

- "C1 & C2" If input C1 is high and C2 is high, the counter is set to zero.
- "/C1 & C2" If input C1 is low and C2 is high, the counter is set to zero.
- "C1 & /C2" If input C1 is high and C2 is low, the counter is set to zero.
- "/C1 & /C2" If input C1 is low and C2 is low, the counter is set to zero.
- "C1 : W" If input C1 is high, the counter is set to zero.
- "/C1 : W" If input C1 is low, the counter is set to zero.
- "C1 : W" If input C2 is high, the impulses of the measuring system are no longer counted.
- "/C1 : W" If input C2 is high, the impulses of the measuring system are no longer counted.
- "C1 : W" If input C1 is high, the counter is set to zero.
- "/C1 : W" If input C2 is low, the impulses of the measuring system are no longer counted.
- "C1 : W" If input C1 is low, the counter is set to zero.
- "/C1 : W" If input C2 is low, the impulses of the measuring system are no longer counted (W = Wait).

"C1 or $\hat{a}C2$ " Counter is set to 0, If input C1 is high or a signal at input C2 changes from low to high.

"C1 or $\hat{a}C2$ ". Counter is set to 0, If input C1 is high or a signal at input C2 changes from high to low.

7.4.1.6.4. Multiturn measuring system with electronic gear

If you selected "MULTI" for your special measuring system in the measuring system input, the following menu is created:

This measuring system is needed when using a multiturn encoder with a non-binary number of rotations.

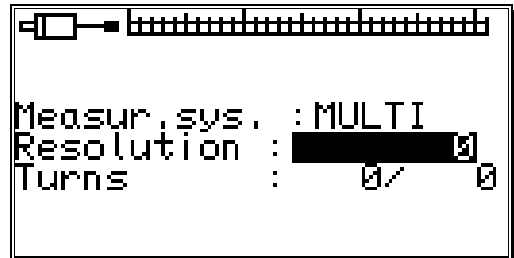

Example 1: You have a rotation plate with an electronic gear rate of 3 to 1, i.e. the encoder rotates 3 times for every rotation of the plate. These three rotations correspond with 360 impulses (360 degrees). You need to make the following inputs:

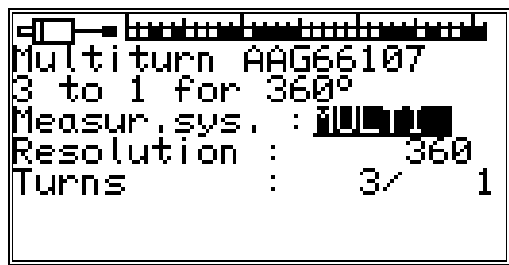

1. Enter the total resolution needed.
Here 360 impulses (360 degrees).
2. Enter the total number of rotations.
Here 3 turns.
3. Enter the divisor for uneven translation rates.
Here 1.
4. Press the key to confirm your inputs and leave the menu.

Example 2: You have a rotation plate with an electronic gear rate of 12.5 to 1, whereas the encoder turns 12.5 times for every rotation of the plate. These 12.5 rotations correspond with 3600 impulses (360.0 degrees). The following inputs are necessary:

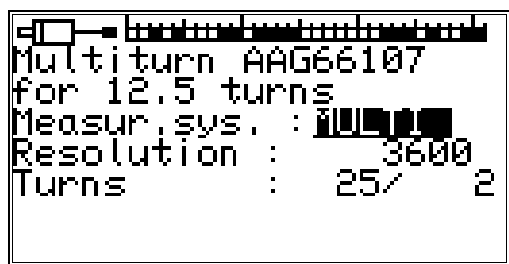

1. Enter the total resolution needed.
Here 3600 impulses (360.0 degrees).
2. Enter the total number of rotations.
Here 25 turns.
3. Enter the divisor for uneven translation rates.
Here 2.
4. Press the key to confirm your inputs and leave the menu.

Attention: This measuring system only works in connection with multiturn encoders with a resolution of 4096 x 4096 impulses (Type: AAG66107 or AAG626).

Note: With this measuring system the encoder may not be moved more than 512 rotations in a cold state.

7.4.1.6.5. PLL measuring system

If you selected "PLL" for your special measuring system in the measuring system input, the following menu is created:

The PLL measuring system determines the way out of temporal interpolation of a measuring impulse. If you e.g. have installed an initiator on a rotation plate and want to determine the current position at a constant velocity without having to install another measuring system, the PLL measuring system is the right choice.

```

┌───┐
PLL measuring system
5 initiators 360°
Measur.sys. : PLL
Impulse/in.: 360/ 15
Init./c-inp: 10/ 16
Window/outp: 100/ 1
    
```

1. Enter the number of steps from initiator impulse to initiator impulse.
2. Now enter the input of the initiator impulse.
3. Now you have to enter the number of initiator impulses per total rotation.
4. Select the input for the clear impulse.
With the PLL measuring system you have the possibility to incase several initiators per total rotation. To receive a zero point you need a zero initiator that can be hooked up to the selected input. If you do not want to use a zero initiator, just enter a "0" here.
5. Then you enter the synchronous window.
If a step error is determined that is larger than the set value, the system enters the asynchronous mode.
6. Now you have to enter the output for the synchronous window that signalizes the synchronous state. If you do not want such an output, just enter a "0" in this line. This output becomes active after the PLL measuring system has been in the synchronous mode for 16 cycles.

Press the CR key to confirm your inputs and exit this menu.

7.4.1.6.6. Timer way simulation (time emitter)

The timer way simulation makes it possible to generate ways (or time related actual positions) time based and without the use of a measuring system. The cam switch unit then behaves similar to the control of a washing machine. For this option you have to select "TIMER" in the special measuring system menu and the following system is set up:

```

┌───┐
Timer
100 impulses in 2 sec
Measur.sys. : TIMER
Impulsetime: 0.020
Resolution : 100
Stop-input : 1
Clear-input: 2
    
```

1. First enter the time between the steps. The finest resolution of the CamCon is 1ms.
In our example we chose 20 ms.
2. Now enter the total number of steps.
We chose 100 steps for our example, so the whole process will be repeated after 2 seconds (20 ms x 100 steps = 2 seconds).
3. After this you have to enter the input for the stop signal.
This will enable the time emitter system. A high signal at this input releases the timer, and the timer is stopped by a low signal. If you do not want a stop input just enter a "0".
4. Finally you have to enter the input for the clear signal.
With this signal the time emitter system can be reset to 0. A high signal at this output causes the timer to remain at "0". If you do not want a clear input, just enter a "0" in the corresponding line.
5. Press the CR key to confirm your inputs and exit this menu.





7.4.1.6.7. RS232 measuring system

The RS232 way gathering is needed, if the measuring system used by you does not contain any of the interfaces described in the previous chapters.

To use this system you have to select "RS232" in the special measuring system menu and the following menu is set up:

```

RS232 way gathering
with Stegmann Pomux
Measur. sys. : RS232
Baud rate: 19200,8,n,1
Comm. prot: POMUX203BCD
Resolut. : 0
Pre divis: 0
    
```

1. First you have to enter the baud rate using the  and  keys.
2. The data transfer protocol can be set with the  key and the  key as before. At the moment only the data transfer protocol of a Stegmann Pomux 203BCD is available.
3. The resolution gives the value in which the actual position of the measuring system is moving.
4. The prescaler (predivisor) divides the resolution to enable the setting of the measuring system in devices with lower memory.
5. Press the  key to confirm your inputs and exit this menu.



Attention: This measuring system may only be used on a CamCon DC50/51, since it blocks the serial interface, making the programming via a PC or a terminal impossible!

7.4.1.6.8. AG615 - Single - Multiturn - Measuring system

Having selected "AG615" in the special measuring system-menu, the following menu appears.

The AG615 - Single - Multiturn - measuring system creates a multiturn- i.e. utility measuring system out of an AAG615 - 8192 Singleturn - measuring system.

As a result several rotations i.e. turns at the Single - Multiturn - Measuring system CamCon per rotation of the AG615 appear.

```

AAG615-8192
Single-Multi
Measur. sys. : AG615
Resolution : 3* 360
    
```

1. Give in the number of rotations i.e. turns that shall be created at the CamCon first (e.g. 3).
2. Then enter the resolution that the CamCon shall display or process per turn (e.g. 360).
3. Confirm your inputs using the  key and leave the menu.

Example: For a value of 3 * 360 the CamCon will count thrice from 0 to 359 if the AAG615 encoder does one rotation along the shaft.

7.4.1.6.9. SIM - measuring system simulator

Having selected "SIM" in the measuring system menu, the following menu appears:

```

Encoder Simulator
SIM 8192
Measur.sys. : SIM
Impulses/s : 16384
Resolution : 8192
Stop-input : 0
Clear-input : 0
    
```

The SIM - measuring system - simulator enables creating ways or time actual values without measuring system, i.e. on time-basis. On the contrary to timer - measuring systems a higher speed is possible.

1. First enter the speed i.e. number of impulses per second (e.g. 16384).
2. Now enter the complete number of steps (e.g. 8192).
3. Now select an out put for the "Stop" signal. Thereby, the simulator may be enabled. A high signal at this input sets the simulator to run, a low signal stops the smultor. If you do not want an Stop-input, simply enter a "0" here.
4. Finally enter the clear signal's input. With this function, you are able to enable the simulator. A "high" signal at this input leaves the simulator at "0". If you do not want a clear-input, simply enter a "0" here.
5. Use the **CR** key to confirm youre inputs and leave the menu.

Example: With a resolution of 8192 and a speed of 16384 impulses per second a simulated speed of 120 revolutions per minute is set.

7.4.1.6.10. HIPER i.e. incremental - measuring system with Roll - Over - funktion

Having selected "HIPER" in the measuring system menu, the following menbu appears.

```

Inkremental HIPER
Measur.sys. : HIPER
Pre Multipl: 5
Pre divisor: 7
Resolution : 360
Clear mode : C1 & C2
    
```



This special measuring system is used if the CamCon is equipped with an incremental measuring system input and an odd resolution of a gear would cause an adding measuring failure.

1. Enter the gear reaktion first by the multiplier and devisor (e.g. 5 / 7).
Note: Every change of edges is counted = quadruplication
2. Now enter the total number of steps i.e. incremets that can be counted by the CamCon (e.g. 360). If more impulses are counted than set as resolution here, the CamCon restarts counting at zero. If the movement measuring system was set to "linear" at the menu configuration way, the CamCon switches to "Clear....". In this case the resolution has to be set greater or the actual value is set to zero, setting a clear signal.
3. In the filed "**Clear mode**" you can set the functions of the additional inputs C1 and C2 using the keys **◀** and **▶**. You can choose between 8 different types of functions: "C1 & C2", "/C1 & C2", "C1 & /C2", "/C1 & /C2", "C1 : W", "/C1 : W", "C1 or áC2" und "C1 or âC2". See also chapter "7.4.1.6.3. Incremental - measuring system" on page 51.
4. Use the **CR** key to confirm youre inputs and leave rthe menu.

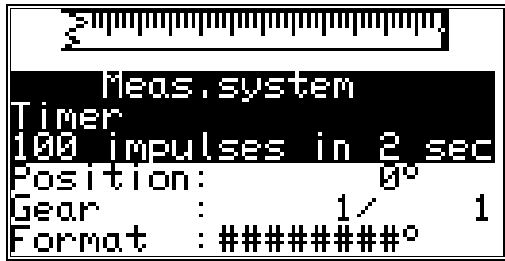

7.4.1.7. Deleting the special measuring system

The special configuration of the measuring system can be removed as follows:

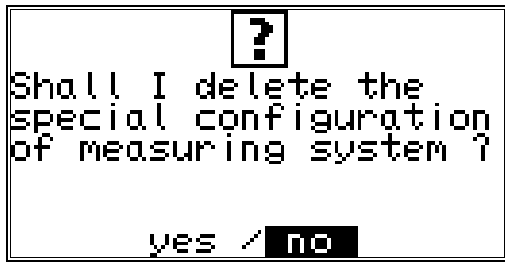

1. Select the menu point "**Measuring system**" in the configuration menu. The following menu is displayed:
2. Select the special measuring system with the  and  keys.
3. Press the  key, and the following question is displayed:



4. Move the cursor to "yes" with the  key and confirm your choice by pressing the  key.

This deletes all settings of the special measuring system.

7.4.2. The measuring offset

If you selected the menupoint "Measuring offset" in the system setting menu, the measuring offset menu appears on the menu:

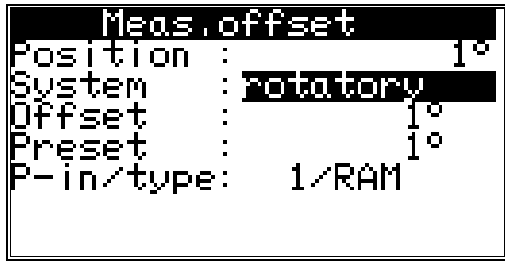

Here you can indicate, using the and keys, whether your controlling system is a rotatory (e.g. an eccentric press) or a linear (e.g. a knee lever press) moved system.

You confirm your input with the key.

7.4.2.1. Zero offset with rotatory movements

If you have chosen a rotatory movement, you can now carry out the input of the offset

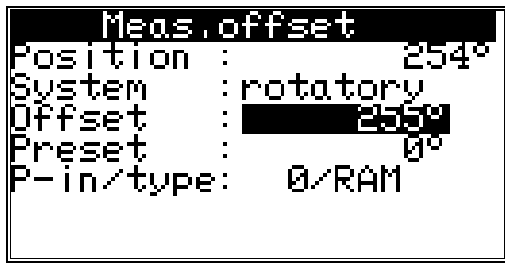

The offset is subtracted from the physical position. This makes it possible for you to shift the zero point.

7.4.2.2. Measuring offset with a linear moved system

If you have chosen a linear movement, you can now carry out the input of the moving range and the offset.

At the menu point "Start" you enter the desired begin of the proceeding range. You even have the possibility to enter negative values.

The "End" value of the measuring range changes automatically and determines the total proceeding way of the measuring system with its position. Here an input is not possible.

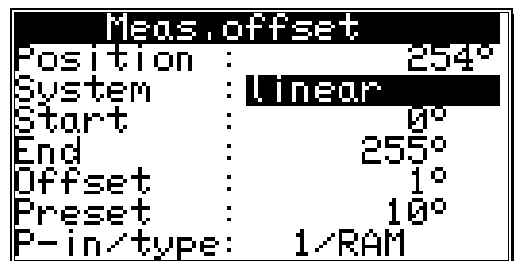

Attention: If the range between start value and end value is under- or overshoot during the way gathering of the measuring system, the CamCon switches off with the error message "Pos.Err 3".

7.4.2.3. Zero offset with linear movements

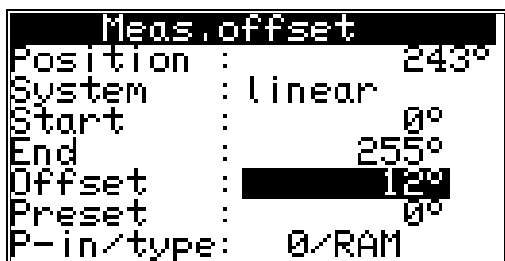

If you have chosen a linear movement, you can now carry out the input of the offset.

In the menu point "Offset" you enter the zero offset of the measuring system. The offset is subtracted from the physical position. This makes it possible for you to shift the zero point.

Note: If the rotation direction of the electronic gear is negative, the offset must be set to a value smaller than zero (e.g. -359). See chapter "7.4.1.4.1. Electronically changing the rotation direction" on page 49.

7.4.2.4. Actual position preset

In the measuring offset menu you have the possibility with the rotary system and the linear system to set the actual position to a new value by creating a new input (preset).

By setting the preset value to zero, you can generate an external zero signal, e.g. to synchronize the cycle of the machine and the actual position of the CamCon.

```

Meas.offset
Position : 243°
System   : linear
Start    : 0°
End      : 255°
Offset   : 12°
Preset   : 13°
P-in/type: 0/RAM
    
```



When you have entered the preset value, the device requests the input number of the preset signal with which the preset is supposed to be initiated. Enter the number next to the "P-In"-put line.

```

Meas.offset
Position : 243°
System   : linear
Start    : 0°
End      : 255°
Offset   : 12°
Preset   : 13°
P-in/type: 5/RAM
    
```

```

Meas.offset
Position : 243°
System   : linear
Start    : 0°
End      : 255°
Offset   : 12°
Preset   : 13°
P-in/type: 5/EEPROM
    
```

Afterwards select, using the keys  and  in the input field "type", the mode of storage of the preset value. Here you have two possibilities:

- "RAM" storage.

Here the preset value is copied into the RAM memory of the device. This means that after switching the device off and on again, the shifting of the actual position equals the zero offset or the offset is no longer available.

- "EEPROM" storage.

Here the shifting of the actual position is copied into the RAM and into the EEPROM memory of the device, making it safe to shut off the device without losing your data.

Attention: *You should only store your data in the EEPROM memory, if the triggering of the preset just occurs rarely and is absolutely required. This is because of the fact that an EEPROM only has a limited number of writing cycles: 100000). Shooting over this maximum number of writing cycles leads to the destruction of the EEPROM and the loss of the program data of the CamCon.*

Note: The preset input will be read in real-time since the software of the 21.5.2002. Therefore, a synchronisation of a device already running is impossible.

Pressing  you can leave the menu.

7.4.3. The speed adjustment

If you selected the menu "Speed" in the system setting menu, the speed adjustment menu appears on the display:

You can use it to optimally adjust the speed of the device to the speed of the gear.

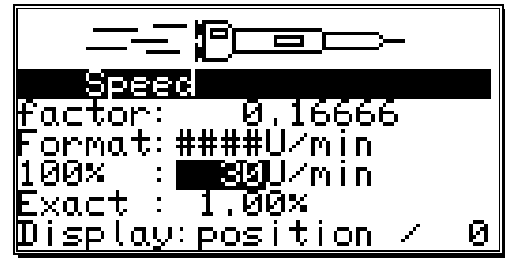

7.4.3.1. The speed factor

Normally the speed is displayed through the number of increments or impulses per second, an output of the measuring system. If you want the speed displayed e.g. in rotations per minute or in the number of pieces per minute, you have to enter a randomizing factor.

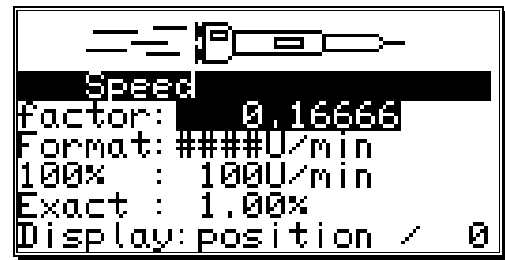

Example 1: A rotation encoder with 512 steps supplies 512 increments per minute, which means that the gear runs with 1 rotation per minute. The CamCon measures $512/60 = 8,533$ increments per second. To receive a display in rotations per minute enter the factor $1/8,533 = 0,1172$.

Example 2: A rotation encoder with 360 steps supplies 360 increments per minute, which means that the gear runs with 1 rotation per minute. The CamCon measures $360/60 = 6$ increments per second. Enter a factor of $1/6 = 0,16666$ to have the display remain in rotations per second.

Note: The speed factor is influenced by inputs in an electronic gear. Also see chapter "7.4.1.4. The electronic gear" on page 49.

7.4.3.2. The display format of the speed display

When you have adjusted the speed range with the factor, you can enter the presentation format of the display, using the and keys (see chapter "5.4. Text input" on page 29).

The # symbols are place holders for the displayed value. If e.g. the highest value is lower than 1000 and only has three digits, you only enter three # symbols. If you want a decimal point displayed, just insert it between the symbols (e.g. : ###.##). Press the key, and the cursor moves to the next menu point.



7.4.3.3. Range adjustment of the speed display

In this menu point you enter the maximum speed of your gear or the speed of your movement. This input is used to adjust the speed display.

An input of e.g. 1000 rotations per minute means that at +/-1000 rotations per minute the maximum analog output voltage, (100%) +/-10V, is reached.

This scale also applies to the speed bar that is shown in the middle of the standard display. Its length is the current speed compared to the entered reference speed in percent. Furthermore this is the point of the speed where the standard display switches from the position to the current speed. This point always lies at 5% of the here entered value, for 1000 rotations per minute it lies at 50 rotations per minute.

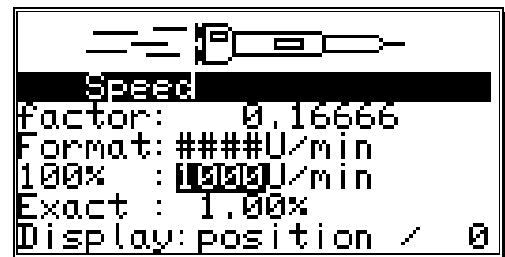

7.4.3.4. Accuracy of the speed display

During operations the speed display usually fluctuates by a certain value. These fluctuations are accounted for in the measuring principle for the speed, since it is a scanning system.

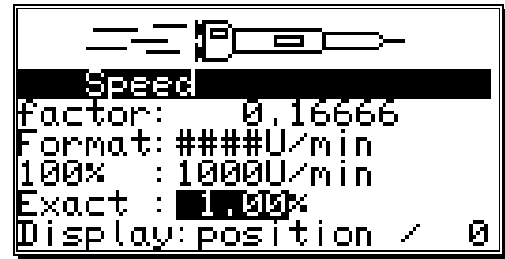

In the menu point "Exact" you can limit these fluctuations to a maximum value. It is a damping through a low pass that results in a smoothing of the display, which means that an averaging process is put into operation. The lower the input value is, the quieter is the speed display. In practice, you will always find a compromise between the dynamics of the display and its readability.

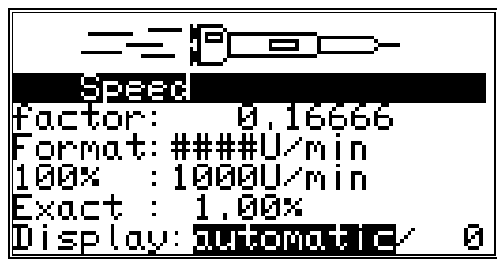

Note: The "Exact" value also corresponds to the speed value, which is provided by an CP16 or CamCon DC115 of an PLC.

7.4.3.5. Display, Type



If you want to prevent the automatic switching at the 5% of the maximum speed in the "Display" menu point, you can select one of the three different display types with the  key and the  key.

- "Automatic" At the 5% point the display is switched from the position display to the speed display. This bar display shows the speed in percent.
- "Speed" Only the speed is shown on the display. The bar display shows the speed in percent.
- "Position" Only the position is shown on the display. The bar display does not show the speed, but it displays the position between 0% and 100% e.g. 0% = 0 Degree / 50% = 180 Degrees / 99% = 359 Degrees.

In addition to the three display types, you can also select the desired display type through an input. The display type has to be set to either "Speed" or "Position", and the number of the input has to be entered in the field behind. When input is passive, the set display type is displayed. When you supply a signal, the display changes from "speed" to position or from "position" to "speed".

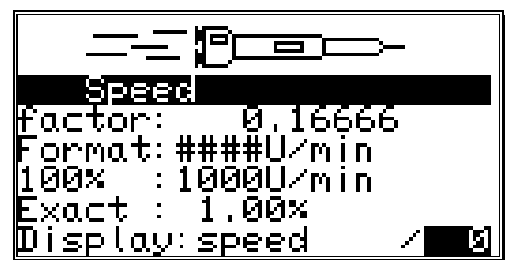

Press the  key to confirm your inputs and exit this menu.

7.4.4. Cable length / Cycle time

If you selected the menu "Cable length/Cycle time" in the system setting menu, the following menu is set up on the display:

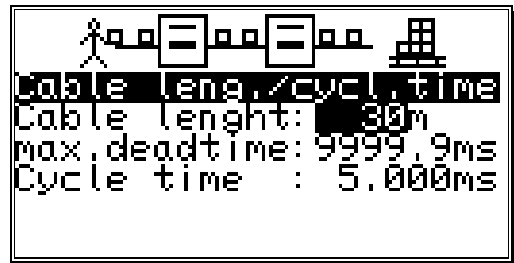

7.4.4.1. The cable length

In this menu point you can set the conduction length between the SSI measuring system and the CamCon, as well as between external input or output extensions and the CamCon, in meters. This is necessary, since the cable length determines the maximum possible speed of serial data transmission. The larger the set cable length, the larger is the cycle time of the transmission and the slower is the data traffic. The cable length can be set to a maximum of 1000m.

Attention!! With cables exceeding 300m in length use a corresponding measuring system as well as extensions with a changed mono-flop-time.

7.4.4.2. The cycle time of the CamCon

Normally the CamCon operates with the shortest possible cycle time. It is displayed as long as the cursor is not on the menu field "Cycle time". With an input in the menu field "Cycle time" this time value can be changed.

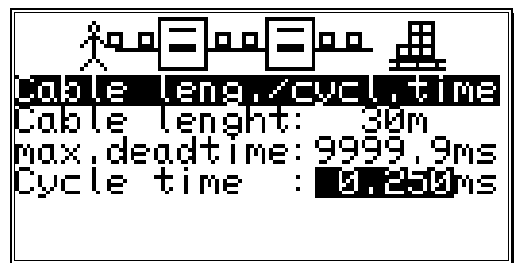

This might become necessary, if e.g.:

- you are programming a large number of outputs with delay time or with a high measuring system resolution and need longer single delay times. These depend on the available memory and the cycle time (see chapter "12. Calculation the RAM storage-requirement for" on page 87). A noticeable change occurs only when the set value lies above the current cycle time. For this reason the display also shows the maximum possible speed compensation.
- you connect a measuring system that allows the readout of the data only once in a given time.

Press the **CR** key to end your input and exit the menu.

7.4.5. The special outputs

If you selected "Special outputs" in the system setting menu, the special outputs menu appears on the display:

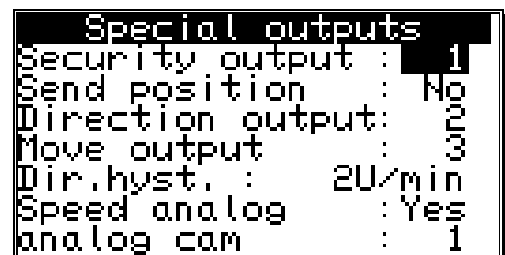

7.4.5.1. The security output

To have the possibility to supervise the CamCon e.g. after short circuits on the output channels or mistakes in the measuring system, you can program a circulation cam for a single output, so that this output is switched off at the occurrence of a mistake and serves as a security output. With a program change, the security output is reset for a short time (see chapter "7.4.6.8. Setting the program selection mode" on page 66).



A "0" in the input field defines that no security output has been programmed..

7.4.5.2. The output of the actual position

The CamCon offers the possibility to put the physical actual position out to outputs. It is used when several CamCon need the same actual position (Master Slave connection). To be able to use this option, the number of the programmed outputs has to be lower than the number of the actually available ones (see chapter "7.4.6.2. Setting the outputs" on page 65. The output of the bit with the lowest value will occur after the last programmed output. The other bits follow in increasing order.

```

Special outputs
Security output : 1
Send position  : gray
Direction output: 2
Move output    : 3
Dir.hyst.     : 2U/min
Speed analog  : Yes
analog cam    : 1
    
```

With the  and  keys you can choose 4 possible output formats:

- "No" = No output of the actual position.
- "Gray" = Output of the actual position in the gray code.
- "Bin." = Output of the actual position in the binary code.
- "Exp." = Output of the actual position in the gray code only for CamCon DC115.

Confirm your input with the  key.

7.4.5.3. Direction output

To be able to recognize the direction of the movement of a machine with different movement directions, you can program an output that switches on at a positive and off at a negative movement.

```

Special outputs
Security output : 1
Send position  : Gray
Direction output: 2
Move output    : 3
Dir.hyst.     : 2U/min
Speed analog  : Yes
analog cam    : 1
    
```

7.4.5.4. The standstill output

The CamCon offers the possibility of a standstill surveillance. Here you can define an output that is switched on when the actual speed is greater than the at "dir Hyst." entered value and that switches off when the speed drops below that value again.

```

Special outputs
Security output : 1
Send position  : Gray
Direction output: 2
Move output    : 3
Dir.hyst.     : 2U/min
Speed analog  : Yes
analog cam    : 1
    
```

7.4.5.5. The hysteresis

To be able to use the options of movement direction surveillance and standstill surveillance correctly, you have to set the hysteresis. This value is needed to suppress the jittering of the outputs at small changes in speed. This value can only be determined through experiments, but it should be as small as possible.

```

Special outputs
Security output : 1
Send position  : Gray
Direction output: 2
Move output    : 3
Dir.hyst.     : 2U/min
Speed analog  : Yes
analog cam    : 1
    
```



7.4.5.6. The analog speed output

```

Special outputs
Security output : 1
Send position  : Gray
Direction output: 2
Move output    : 3
Dir.hyst.     : 2U/min
Speed analog   : Yes
analog cam    : 1
    
```

CamCon emits a voltage (proportional to the speed) on the first analog output (pin 2 at CamCon DC50), 0 to -10V with a negative rotation direction and 0 to +10V with a positive rotation direction, if the menu point "Speed Analog" is set to "yes".

The output voltage reaches its maximum of 10V, when the 100% value, described in chapter "7.4.3. The speed adjustment", is surpassed.

You can deactivate this function by setting the menu point to "no" with keys  and , and confirming it with the  key.

Note: At the time, there are no integrated analog outputs available for CamCon DC16 and DC90. You can add analog outputs by connecting a CamCon DAC16 digital - analog - converter module to the external interface of the CamCon.

Note: To clear the integrated analog outputs please see chapter "7.5.3.3.1. Clearing the integrated analog outputs" on page 74.

7.4.5.7. Configuration of the analog cams



```

Special outputs
Security output : 1
Send position  : Gray
Direction output: 2
Move output    : 3
Dir.hyst.     : 2U/min
Speed analog   : Yes
analog cam    : 2
    
```

With a CamCon cam controller you have the possibility to make an output of free programmable analog values (cams) dependent on the position. You enter the number of analog outputs in the menu point "Analog cams", that you want to program via the CamCon. In most cases, this will also be the number of your analog hardware outputs.

Note: If the menu point "Speed Analog" is set to "yes", the first analog output is used to display the speed, and the number of possible analog outputs is decreased by one.

When you enter the number and press the  key, you enter the input of the specific settings for the analog cams:

First you choose the number of the analog output with keys  and .

Press the  key to confirm the number and change the display to the input of the display format.

```

analog outputs
Nr.      : 1
Format   : ####.##%
Minimum  : -100.00%
Maximum  : 100.00%
Dis.Input : 0
Dis.Wert : -100.00%
Interpol. : Yes
    
```

```

analog outputs
Nr.      : 1
Format   : #####.##%
Minimum  : -100.00%
Maximum  : 100.00%
Dis.Input : 0
Dis.Wert : -100.00%
Interpol. : Yes
    
```

Here you enter your desired format, as described in chapter "5.4. Text input" on page 29. It is e.g. possible to make the input in percent "#####.##%" (standard), in voltage "###.###V", in bar "#.###mbar" or in Ampere "##.###mA". The double-crosses are just placeholders for the real numerical values. The scaling of the input values is done in menu points "Minimum" and "Maximum".

```

analog outputs
Nr.      : 1
Format   : ##.###mA
Minimum  : 4.0000mA
Maximum  : 20.0000mA
Dis.Input : 0
Dis.Wert : 4.0000mA
Interpol. : Yes
    
```

When you confirm the format with the **CR**, you enter the input for the minimum value.

Note that CamCon always calculates with an accuracy of 16 Bit. The minimum value is the bit value 0 (e.g. -10V or 4mA) and the maximum value is the bit value 65535 (e.g.+10V or 20mA). The values should be entered according to the purpose of the device. If e.g. an CamCon DAC16/I module (current output) is connected to the

external display, the input can be made in milliampere, or the milliampere value corresponds to a physical pressure - or speed, this value can also be entered in bar or meters per second (see values in figure above).

Note: The integrated analog outputs of the CamCon DC40, 50 and 115 all work with an accuracy of 8 Bit. The output of the analog cam values is recalculated from 16 bit to 8 bit in this case.

After the minimum and maximum values have been confirmed with the **CR** key, the com inputs in the programming menu are restricted to the range between minimum and maximum and recalculated, if necessary.

The output of the analog value can be stopped by setting an input to a specific value. For this purpose enter the input number in the menu point "**Dis.inp.**" (Disable Input), with which the analog value is set to the "**Dis.val.**" (Disable Value). The "Dis.value" must be within the range of minimum and maximum. The "Dis.val." is automatically set as a default value, if no cam has been programmed on the analog output.

When the "Dis.val." is confirmed you can activate ("yes") or deactivate ("no") the interpolation of the analog value with the keys **◀** and **▶** in the menu point "**Interpol.**". If this value is set to "yes", CamCon interpolates the programmed values from definition point to definition point.

Example:

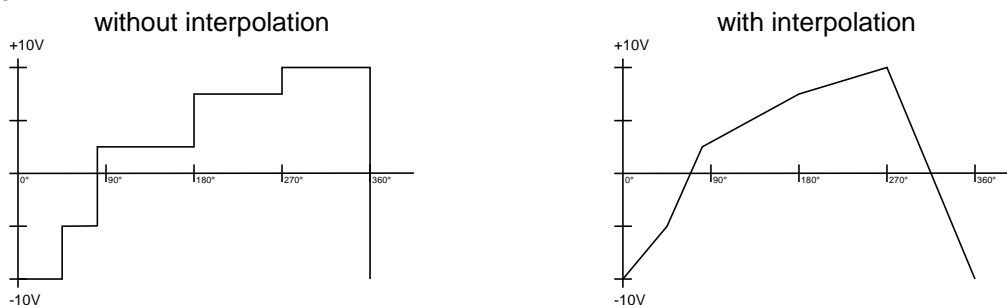

By pressing the **CR** key, the input of the interpolation is confirmed, and you move back to the selection of the number of the analog output. Here you can choose the number of the next analog output with the keys **◀** and **▶** and proceed with the input of the values as before.

When the input is finished, you can leave the menu by pressing the **ESC** key.

For the input of the cam values please see chapter "7.3.17. Programming analog cams" on page 45.

7.4.5.8. The analog position output

The analog position output of the CamCon can be programmed with a software version of at least DC50.20, by the input of an analog cam. Herefore you program an analog cam, that emits -10V at an actual position of 0 degrees and +10V at an actual position of 359 degrees (see chapter "7.3.17. Programming analog cams" on page 45).

7.4.6. System upgrading

If you selected the menupoint "**System upgrading**", the following menu appears on the display:

```

System upgr.
Inp.: 8   Outp: 32
DTC outputs: 32
K-lock-inp.: 0 EQ 0
Enable-Eing. : 0
Prog.-select-Input: 0
NoP.: 1 Typ: on pos.
change at : 0°
    
```

7.4.6.1. Setting the inputs

Here you can enter the number of inputs available to the CamCon. This number of inputs should always be exactly the same as the number of electrical inputs, since the short circuit detection of the CamCon reacts to the number of inputs.

7.4.6.2. Setting the outputs

Here you can enter the number of outputs available to the CamCon. This number of outputs should not be greater than the number of electrical outputs, since this only results in a waste of memory and cycle time. If you want to make an output of the actual position at the outputs, you have to decrease the number of outputs by the corresponding number of bits (see chapter "7.4.5.2. The output of the actual position" on page 62).

7.4.6.3. Setting the outputs with speed compensation

Here you can enter the number of outputs with speed compensation available for the CamCon. The number of outputs should not be greater than the maximum number of the absolute necessary outputs; otherwise only memory and cycle time are wasted.

7.4.6.4. Setting the keyboard lock

Assigning a +24VDC level to the programmed input pin will disable the keyboard. After this it is not possible to program or initialize the device any more. Resetting the value to "0" will enable the keyboard again.

7.4.6.5. Error - acknowledging Input (EQ)

A positive edge (+24V DC) at the input number shown here leads to acknowledging an error-notice at the CamCon "Pos-Error": 1,2,3 and 5 **but not** an output error"

7.4.6.6. Input for enableing Outputs

A signal (+24V DC) at the input-number shown here enables Cam-outputs, an 0 signal locks Camoutputs. If this value is set to "0", the "enableing function is inactive and the Cam-outputs are permanently enabled.



Note: If a PLC-Logic-module is switched on, this effects rather the "0"-outputs but the Cam-outputs "N".

Note: Using a CamCon with direct PLC-attachement via CP16 or CP340 respective a CamCon DC300 and 1756-DICAM, these enableing-functions should be switched off (0), for the PLC-enableing-function takes on their function.

7.4.6.7. Setting the external program selection

With the CamCon you have the possibility to externally select the desired program number through the inputs. Here you enter the number of programs that can be selected externally, and this simultaneously predefines how many inputs will be used for this purpose. Then the input for the take over impulse is stated. The program number is created as a binary number at the inputs after the take over impulse. The bit with the lowest value is the input after the take over impulse, all others then follow it in an increasing order. Because of this the inputs for program selection are completely relocatable.. With an impulse (+24V) the program is selected at the input of the take over impulse. This impulse has to be created at least 20 ms after the program number and has to be at least 20 ms long.

7.4.6.8. Setting the program selection mode

You can change programs in several ways. Here you have the possibility to determine the desired way to change the programs with keys  and . You can select between:



- "**slow**" Here the selected program is built up cam after cam. This type of program changing requires the least memory, but a complete change of programs during a full run can lead to complication with the machine. In this case the security output of the CamCon is switched off for a short time.
- "**direct**" Here the selected program is built up cam after cam in an intermediate memory and changes the full program at once. This type of program changing requires the double amount of memory for the cam build up, but the outputs are always defined in every cycle. The security output of the CamCon will not be switched off in this case.
- "**on position**" The program is built up in the same way as in the "direct" type, but here the CamCon waits with the program change until the machine has passed a certain position and then makes a complete program change. This type of program changing also requires the double amount of memory for the cam build up, but the outputs are always defined in every cycle. The security output of the CamCon will not be switched off in this case.

7.4.7. Masterprogram

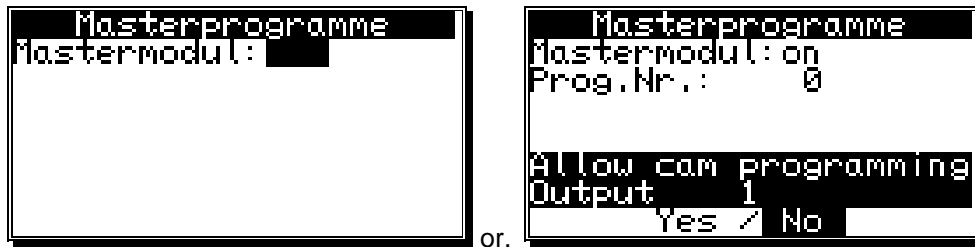
Having selected "Masterprogram" in the menu "system config" you will get to the following display.



Here you are able to define Cams for different products and programmes. They could be necessary if your plant produces different types of products that have only very little differences concerning their Cam-adjustment. You are able to save a lot of storage for Cams (EE-Prom), because these mastercams do not need to be programmed multiple.





If you wish to use this funktion, at first the "Mastermodule" must be switched "on" using key , that has to be confirmed by pressing .



Now enter the masterprogramnumber by wich the Mastercams will be saved. You can use every programnumber from 0 to 32767.

Having confirmed the masterprogramnumber by pressing , you have to define which Output or Camtrack shall be used as Mastercam.



Here you can switch the outputs access to the masterprogram on (YES) or off (NO) by pressing  and . The keys  and  are used to select the favoured Outputmuber or Camtrack. Pressing  quits the input.

Example:

Having adjusted the masterprogramnumber 32767 on and switched output 1 on YES, a Cam in Program 32767 programed for output 1 will be also editet, if automaticprogram is set to 0. Cams in Programm 0 programed for output 1 will be ignored though.

To program a Mastercam, switch to menu "programming" and choose your favoured outputnumber. If you are not in the Masterprogram while putting in Cams, the system automatically switches to Masterprogram so that you can change a Mastercam.

Note: In putting in Cams in the "Programming"-menu the only possibility to change Mastercams, if your logged in with an user key, that has access to "System config". This disables a user at the plant to change MasterCams. The procedure of the plant can therefore only be changed by a person that has the essential access-key-code.

Note: If choosing the Masterprogram to program Cams, only MasterCams may be changed.

Note: If an automatic-program is set on the Masterprogram's number, only the Cams programed by Masterprogram will be put out.

7.5. Unit configuration

At the first activation of the CamCon, you should initiate a complete deletion and, if desired, allocate the user keys for associates. To do this, select the main menu point "**Unit configuration**". The display changes to display the configuration menu:

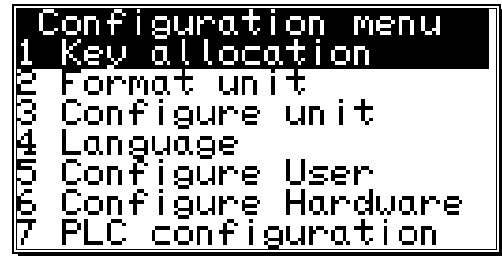

7.5.1. User key allocation

You can assign different user keys to your associates, each with different access rights.

Attention: *As long as no key is created, you can enter every menu with the key code "5693". When you create your first key, this master key is automatically deleted. If you forget to create at least **one** key that allows access to the configuration menu, you have locked yourself out of the configuration menu as soon as you leave it. This can be overcome by sending the unit back to Digitronic or with the entry of a special supervisor number. You can acquire this number with a phonecall to Digitronic Automationsanlagen.*









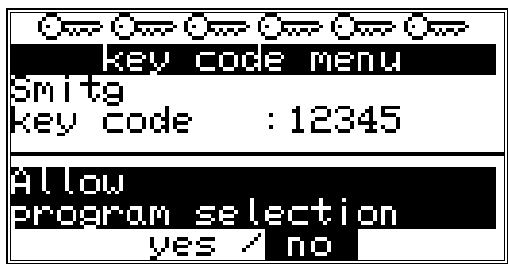
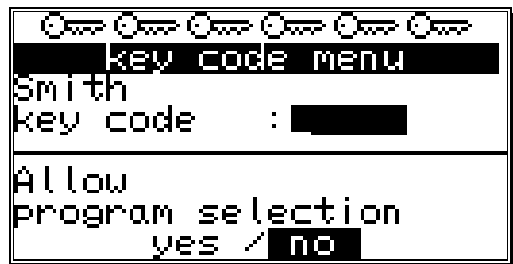
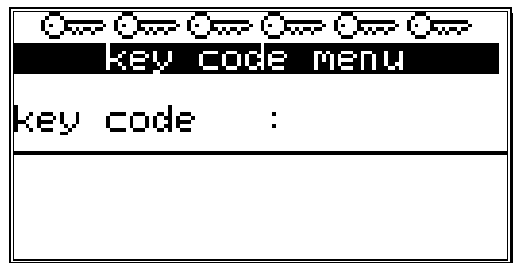



7.5.1.1. Creating a new user key



Follow these steps to create a new user key:

1. Select the menu point "**Key allocation**" in the configuration menu; the display changes to the key allocation menu:
2. Press the **INS** key, and the input field for the name is underlined in black.
3. Enter a name. See chapter "5.4. Text input" on page 29.
4. End the text input with the **CR** key, and the cursor moves to the input field "**Key number**".
5. Enter the key code with the numeric keys (up to 5 numbers).
6. Press the **CR** key. The cursor moves to the input field for the **access to the program selection**.





7. Choose between "**yes**" and "**no**" with keys **◀** and **▶**.
8. Press the **CR** key. The cursor moves to the input field for the **access to the cam programming**.
9. Choose between "**yes**" and "**no**" with keys **◀** and **▶**.
10. Press the **CR** key. The cursor moves to the input field for the **access to the system menu**
11. Choose between "**yes**" and "**no**" with keys **◀** and **▶**.
12. Press the **CR** key. The cursor moves to the input field for the **access to the configuration menu**.

13. Choose between "yes" and "no" with keys  and .
14. Press the  key. The cursor moves to the input field for the **access to the outputs, generally and for every output**.
15. Choose between "yes" and "no" with keys  and .
16. Press the  key. If you chose "no" in the previous input field, you can now assign the access to each output one by one.
The cursor moves to the input field for the **access to output No. 1**.
17. Choose between "yes" and "no" with keys  and .
18. Press the  key. The cursor moves to the input field for the **access to output No. 2** and so on...
19. You can leave this menu at any time by using the  key.



Note: You can also select the menu fields for the single access rights with keys  and .

7.5.1.2. Deletion of a user key

You can delete a user key according to the following procedure:

1. Select the menu point "Key allocation" in the configuration menu; the menu for the key allocation appears:
2. Select the user key you want to delete with keys  and .
3. Press the  key; the display shows the question:







4. Move the cursor to "yes" with the  key.
5. Press the  key, and the key is deleted.

Additionally: If you happen to delete every key in this menu, the standard key code "5693" is automatically generated.

7.5.1.3. Checking the key configuration

You can check an allocated key the following way:

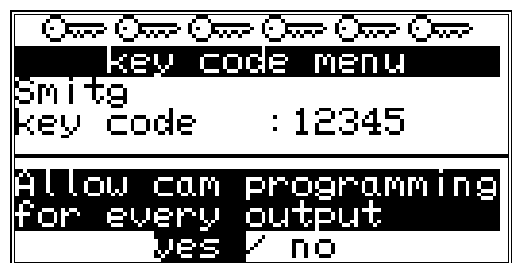

1. Choose the menu point "Key allocation" in the configuration menu; the menu for the key allocation appears:
2. Select the key that is to be checked with keys  and .
3. Now you can check the single access rights mit keys  and .

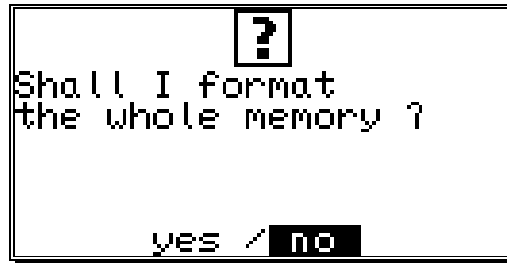

7.5.2. Complete deletion

If you selected the menu point "**Complete deletion**" in the "**Unit configuration**" menu, the display shows :



You can move the cursor to "**yes**" with the  key and confirm it with .

After a short while the display returns to the main menu. This time depends on the size of the EEPROM used, since the memory has to be formatted. Using e.g. a 32k EEPROM the process takes about 2 minutes. Afterwards, the complete deletion is complete. All cams are deleted, and the system registers have their standard values.

Now you can begin with the programming.





Attention: Deleted information cannot be restored.

7.5.3. Unit configuration

If you selected the menu point "**Configure unit**" in the "**Unit configuration**" menu, configuration menu appears on the display:

7.5.3.1. Setting the serial interface

You can select the mode of the serial interface with keys  and  in the input field "**Ser.mode**", confirming your selection with the .key afterwards There are five different types of operation available : 1. = "Cam-BUS", 2. = "Standard", 3. = "Multiuser", 4. = "S5-L1" and 5. = "3964R". When you select a specific communication mode, you have to make sure, that every connected device you want to make contact with supports this communication mode. Please note also, that you can specify the type of serial interface with your order of the CamCon. You can choose between an RS232 or an RS485 interface. All four "Ser.Modes" operate with the RS232 point to point communication as well as with the RS485 BUS communication. See also chapter "4.6. Terminal connections of the serial RS485 interface" on page 18 and chapter "7.5.3.1.6. Input of the unit number" on page 72.

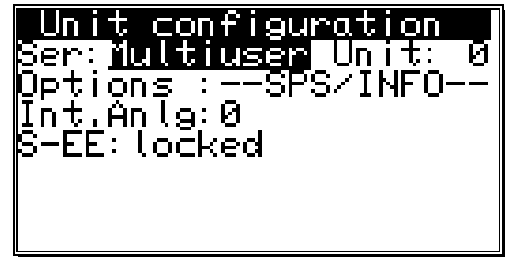

Note: As a standard, the device comes with Ser.Mode set to "**Multiuser**" and the unit number set to "**0**".

7.5.3.1.1. The "Cam-BUS" communication mode

Select this mode, if you want to be able to program or display CamCon cam controllers from different places, e.g. you want the CamCon, the daughter display CD10 and the PC via the RS485 BUS.

Attention: Using the configuration above or similar requires that **all** CamCon devices, as well as any connected PC be equipped with an RS485 serial interface and a software of at least December 1996.

7.5.3.1.2. The "Standard" communication mode

The standard mode operates with point to point communication, i.e. you can only connect 2 devices, e.g. a CamCon to a PC or a CamCon to a CamCon DC50/51 Terminal. Since this communication mode does not use any protocol security, its usage is only allowed for testing purposes.

7.5.3.1.3. The "Multiuser" communication mode

Contrary to the "**Cam-BUS**" mode, it is "**not**" possible to operate several devices, e.g. CamCon Terminal DC51/T4, the daughter display CD10 and the PC, on the RS485 BUS. (**PRESET**)

7.5.3.1.4. The "S5 - L1" communication mode

This setting is necessary, if you want to program the CamCon device via a Siemens S5 CPU. The process is a point to point communication, i.e. you can only connect the CamCon and the Siemens S5 CPU. If you want to store the data of your CamCon on a PC, you have to brake your connection to the S5 CPU. For the S5 - L1 communication mode, you can order a connection set compsed of : a TTY cable, function segments and a handbook (Ordering.No.: PCXX/S5-L1 XX=CamCon Type).

7.5.3.1.5. The "3964(R)" communication mode

This setting is necessary, if you want to program the CamCon device via a seriell interface with the RK512 prozedur. The process is a point to point communication.

7.5.3.1.6. Input of the unit number

In the Multiuser and in the Cam-BUS operation, you need to set a unit number for every device on the BUS. This number can be set under the menu point "UnitNo:" and is then displayed in the main menu in the highest line on the display. You may only allocate each unit number once for a single linked RS485 BUS operation. Because of this, you need to set the "UnitNo" and the "Multiuser" or "Cam-BUS" mode for every device separately, before connecting the serial interfaces.

7.5.3.1.7. Programming via remote

If you want to program the CamCon from a separat control, you can order a handbook with a description of the programming sequences (Ordering.no.: H-DC50/PROTO).

7.5.3.2. Additional device options

At the time, the CamCon has the options "PLC", "SPS/INFO/HSR" and "PLC/INFO" available. If want your CamCon to be equipped with one of these options, please specify with your order : ("PLC" = S) ("PLC/INFO" = M) ("SPS/INFO/HSR" = C).

These options are described in an extra handbook (H-PLC), which is not in the supply package of the CamCon.

7.5.3.2.1. PLC Logic Module

The firm Digitronic Automationsanlagen GmbH is an accomplished and well-known supplier and developer of electronic cam controllers for the industry. The experiences of connecting PLC controls and cam controllers, collected in years of close cooperation with the users, have been regarded during the creation of the PLC Logic Module. The result is a PLC software for the CamCon, that works parallel to the cam controller. The in- and outputs of the cam controller are linked without external logics or hardware, e.g. Timers (Way - Time - Cams), Set - Reset - Functions, and registers and can so be operated within the cycle time of the cam controller. This combination guarantees the best possibility of using the advantages of the CamCon speed compensation and the logic of the PLC, without the loss of switching speed because of slow external switching elements (e.g. relays, timers and central PLC controls with high cycle time).

7.5.3.2.1.1. Examples for using the PLC logic module

Example 1: Output deactivation.



Output 1 of the CamCon is cleared if inputs 1 and 8 are active.

Example 2: Output depending on the rotation direction.

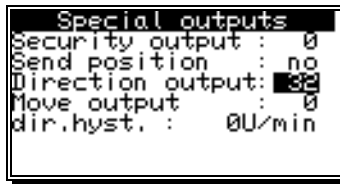

Output 1 of the CamCon is enabled when the rotation direction output 32 is **active**.

This is the case when the direction of the rotation is **positive**.

Output 1 of the CamCon is enabled when the rotation direction output 32 is **not active**.

This is the case when the direction of the rotation is **negative**.

Example 3: Flank assessment.

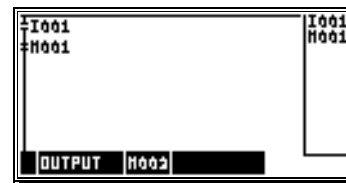

Register 2 is activated for one cycle when the signal at input 1 changes from 0 to 1.

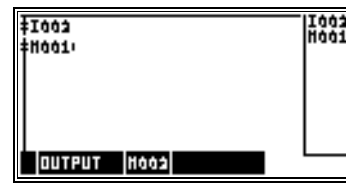

Register 2 is activated for one cycle when the signal at input 2 changes from 1 to 0.

7.5.3.2.2. PLC Logic Module with text display

Available with the PLC Logic Module is a text display you can use to show and describe the different states of your machine.

Example:

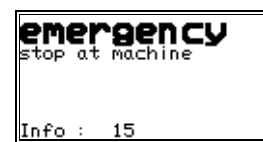
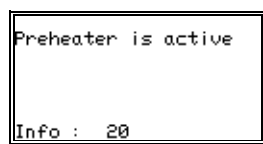
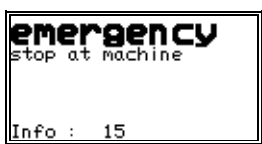

7.5.3.3. Analog outputs

The electronic cam controllers of the CamCon series are equipped with analog outputs (CamCon DC40/50/51 optionally, CamCon DC115 as a standard), via which speed, position or the cam values can be emitted as analog signals.

Note: With units CamCon DC16, DC90 and DC300 you can only use the analog outputs by connecting a CamCon DAC16 digital - analog - converter to the external interface.

7.5.3.3.1. Clearing the integrated analog outputs

At the time, units CamCon DC40/50/51 (optionally) and CamCon DC115 (as a standard) are supplied with integrated analog outputs. The outputs are cleared by setting their number in the menu point "Int.Anlg". The possible numbers are 0,1 and 2. A value of 0 deactivates the integrated outputs.

Note: Not possible with CamCon DC16 and DC90.

If the value is greater than 0, a line for adjustments appears below the menu point "Int.Anlg".

```
Unit configuration
Ser:Multiuser Unit: 0
Options :--SPS/INFO--
Int.Anlg: 0
S-EE: unlocked
```

7.5.3.3.2. Adjusting the integrated analog outputs

Note: With units of increment DC51/S5., DC51/J5.. or DC40/S5.. this feature is neither necessary nor possible.







The integrated analog outputs of the CamCon have to be regulated from time to time and after the first activation. Offset and amplification can be adjusted. The maximum analog output voltage is $\pm 10V$ with a resolution of 8Bit. Should you wish for a smaller voltage range, you can edit the maximum voltage via the amplification factor.

Offset output 1

```
Unit configuration
Ser.mode:Multiuser
Unitno. : 1
Options :--SPS/INFO--
Int.Anlg: 2
Analog 1=> 0.000V ←→
```

Amplification factor output 1

```
Unit configuration
Ser.mode:Multiuser
Unitno. : 1
Options :--SPS/INFO--
Int.Anlg: 2
Analog 1=> 10.000V ←→
```

With keys  and  you can set the amplification and the offset through repeated adjustments with the keys and measuring the analog output voltage. From analog output 1 to analog output 2 and to switch between offset and amplification factor, press keys ,  or . When all 4 adjustments are made, the input is ended with the  key and the menu is left.

See also chapters "7.4.5.6. The analog speed output" on page 63, chapter "7.3.17. Programming analog cams" on page 45 and chapter "7.4.5.7. Configuration of the analog cams" on page 63.

7.5.3.3.3. External analog outputs

Additional external analog outputs can be connected to a CamCon through a CamCon DAC16 digital - analog - converter module at the external interface.

7.5.3.4. Locking EEPROM memory

If an PLC-controll writes or programs parameter, Cams or Delay-Times cyclical (eg. DC300 or CP16) the unit's EEPROM-Memory will be destroyed after a short time. If cyclical programming is, for a certain reason, necessary, you therefore have to lock the EEPROM.

```
Unit configuration
Ser: Multiuser Unit: 0
Options : --SPS/INFO--
Int. Anlg: 0
S-EE: Locked
```

Therefore select **S-EE** in menu "unit configuration" and change it by pressing  to "locked". If the EEPROM is locked, all data will only be written to RAM and will be deleted if the voltage is switched off.

Attention: After having finished a complete deleting, this value is set to "unlocked" again.

7.5.3.5. Process alert respective Interruptfunction

```
Unit configuration
Ser: Cam-Bus Unit: 0
Options : ----SPS----
DC300 Proz.: 0
S-EE: unlocked
```





The CamCon DC300 may, for an edge at output 1, cause a process alert respective interrupt at the S7-CPU. For this purpose, enter a "1" in this menu point.

If now a positive or negative edge is detected at output 1, the S7-CPU calls imideatly OB40.

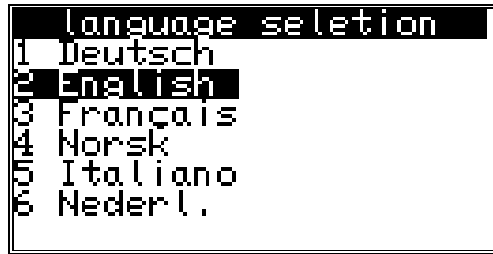
7.5.4. Language

If you selected the menu point "Language" in the "Configuration" menu, the menu for the language setting appears:



Here you can move the dark field to the desired language using the keys , ,  and . You adapt the selected language by pressing the  key.

7.5.5. Configure user

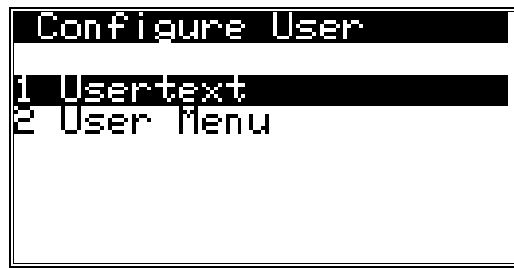

If you choose the menu-point "Configure User" in the menu "Unit Configuration", the following menu appears on your display.

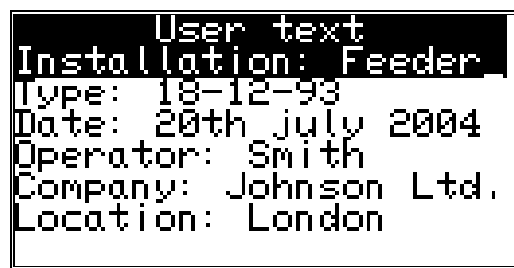

7.5.5.1. User text

If you selected the menu point "User text" in the "Configuration menu", the following menu appears on the display. Here you can enter general information about e.g. your machine for the CamCon to display. There are 7 lines available, with 21 characters each.



For the input of the text please see the chapter "5.4. Text input" on page 29. You can store the text and move on to the next page by pressing the  key. You can exit this menu at any time with the  key.

7.5.5.2. User-Menu/OP-functions

If you choose the menu-point "Configure User" in the menu "User menu", the following menu appears on your display.



Here you are able to feed in own input- or displayfunctions into the CamCons Standart-Display. This helps the final customer to change or controll Cams, delay-times and Variables of the PLC-Logic-Module without having to interfere with the units sub-menus.

For informations about Input or definition of this feature please read chapter "User's menu/ OP-Functions" in the PLC-Logic-Module's manual (Best.Nr: H-SPS).

7.5.6. Configure Hardware

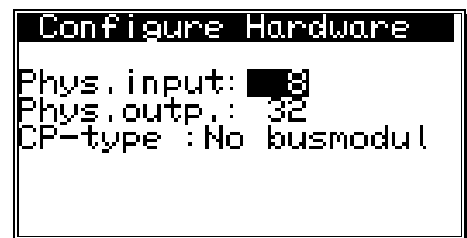

Fill in the physical inputs and outputs here.

Using e.g. a CamCon DC90 this would be 16 inputs and 24 outputs, using a DC16 8 inputs and 16 Outputs, using a CamCon DC300 8 inputs and 24 outputs or using a CamCon 1756-DICAN 0 inputs and 24 outputs.

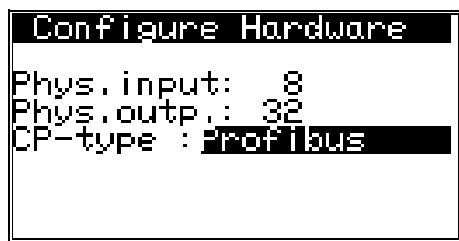

7.5.6.1. CP16 Module



If a CP16 Profibus (CP16/P) or Interbus (CP16/I) Module gets connected to your CamCon, you can switch the CP-type by pressing  to "Profibus" respective "Interbus"-press key .

Using a Profibus-DP-Module you can now enter your favoured Profibus-DP-adresse and confirm by pressing .

Additional to the CamCon's physical In - or Outputs the CP16 - module is able to simulate In - or Outputs, that can be evaluated or controlled by an PLC

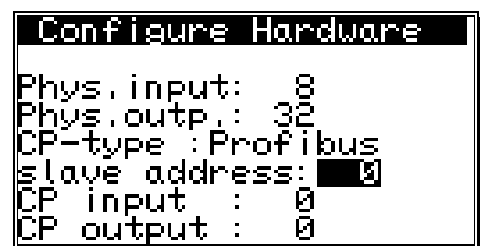

Attention: Simulated Inputs, controlled by PLC must not be directly frequented in Cam-switch or PLC-Logic-module, forbeeing not defined for an accurate establishing of communication between CamCon CP16 and CamCon Cam-switch. The Inputs therefore have to be connected with special-input 5 of the PLC-Logic-module AND, which will be set to 1 if sucessfully establishing communication to CP 16.

Note: For more information about the features of an CP16 Module please read the CP16 manual.

8. Device info

If you want to get an overview of whole configuration of the CamCon, you should select the information menu of the unit configuration. Select the main menu point "**Unit configuration**", and press the **ESC** key during the input of the user code (the input of the user key is not required here) or you press the **#** key in the "**configuration menu**". The first page of the information menu appears on the display. With the help of the arrow keys or the **CR** key you can view the other pages. You can exit this menu at all times by pressing the **ESC** key.

```

User text
Installation: Feeder
Type: 18-12-93
Date: 20th july 2004
Operator: Smith
Company: Johnson Ltd.
Location: London
    
```

- User text inputs

```

Info: memory
EPROM: 19.12.1996
Cam      : 2603/ 71
Dead time : 4722.9 ms
Resolution : 8192
RAM size  : 131072
Ser. EEPROM: 0
Par. EEPROM: 32768
    
```

- Software version
- Number of free cams / number of programmed cams
- Maximum delay time setting
- Maximum setting for the physical resolution of the measuring system
- Size of the RAM in bytes
- Size of the EEPROM storage in byte

```

Info: Measuring sys.

Measur.sys. : TIMER
Hy./Vmax: 0/ 0
Gear      : 1/ 1
Format    : #####°
    
```

- Configured measuring system
- Actual position hysteresis (Hy.)
- Encoder controlling (Vmax)
- Rotation direction and gear factor
- Display format of the actual position
- Display of actual Value

```

Info: measuring sys.
SSI Singleturn
360 Gray
Measur.sys. : SSI
Res./offset : 9/ 9
gray offset : 76
SSI-errorbit: 14
    
```

- detailed configuration of the measuring system

```

Info: measuring offset
System      : linear
Start      : 1°
Offset     : 2°
End        : 360°
Preset     : 3°
P-inp/typ: 5/EEPROM
    
```

- Configured moving system
- Activation point of the linear moved system
- Offset (shifting of the zero point)
- Value of the actual position preset
- Input number of the actual position preset / Memory of the actual position preset

```
Info: speed
factor: 0.16666
Format:####U/min
100% : 1000U/min
Exact : 1.00%
Display: position / 0
```

- Factor of the speed display
- Display format of the speed display
- 100% value for the speed display
- Accuracy of the speed display
- Display menu of the display type / Input for the display change.

```
INFO: Cable l./cycle
Cable length: 30m
target time : 0.000ms
Cycle time : 0.152ms
Temperature : 35°C
```

- Cable length of the measuring system and the external upgrade
- Set planned value of the cycle time
- Cycle time need by CamCon
- Temperature in the encasement of CamCon

```
Info: Special outputs
Security output : 1
Send position : No
Direction output: 2
Move output : 3
Dir.hyst. : 2U/min
Speed analog : No
analog cam : 0
```

- Output number of the security output
- Format of the displayed actual value
- Output number of the F / R output
- Output number of the stand still output
- Hysteresis for the recognition of the stand still speed
- Analog speed output "yes/no"
- Number of analog cam outputs

```
Info: System upgrad.
Inp.: 8 Outp: 32
DTC outputs: 32
K-lock-inp.: 0 EQ 0
Enable-Eng. : 0
Prg.-select-Input: 0
NoP.: 1 Typ: slow
```

- Number of inputs and outputs
- Number of outputs w. speed compensation
- Input number for keyboard locking
- Input number of error acknowledgement
- Input number for output enable
- Number of externally selectable programs
- Input number of the first input for the external program selection
- Change mode of the program selection

```
INFO: Hardware
Phys.Eng.: 8
Phys.Ausg.: 24
CP-Type : Profibus
Slave Adresse: 4
CP Eng. : 8
CP Ausg. : 8
```

- Configuration of physical hardware in- and outputs
- Configuration towards the CP-16-module (Profibus, Interbus, Can-Bus).

```
Info: PLC
PLC-module: on
MRegisters: 0
XRegisters: 0
Timer/Cnt.: 0 ( 0)
Virt. inp.: 000
Spec. inp.: 0
Shift: 0* 1 ( 0)
```

- PLC logic module configuration
- PLC-Logic-module ON/OFF
- Number of M-Registers
- Number of X-Registers
- Number of counters and times
- Number of virtual inputs
- Number of special inputs.
- Number of shift registers with speed compensation

```
Info: Options
Ser: Multiuser Unit: 0
Options : --SPS/INFO--
Int. Anlg: 0
S-EE: unlocked
BCLK: 45Mhz BL: 5
EE-WR_CNT: 9257
```

- Mode of the serial interface
- Unit number
- additional options of the e.g. PLC option or PLC option with text display
- Number of internal analog outputs
- CPU - Speed (clock) 16 or 25 Mhz
- Hardware PLC - acceleration (on/off)

```
Info: Analog outputs
Nr. : 1
Format : ###.##%
Minimum : -100.00%
Maximum : 100.00%
Dis. Input : 0
Dis. Wert : -100.00%
Interpol. : Yes
```

- Configuration of the analog cam 1,2, up to 13.
- Input and display format
- Minimal input value (- 10V)
- Maximum input value (+ 10V)
- Input number for switch to dis.value
- Output value if switch off
- Interpolation yes/no

For each of the analog cam the CamCon displays one more information menu. A maximum of 13 analog cam are possible.

```
Info: Userin.F: 0.0
Headline :
1 Line
2. Headline :
last line:
```

- Adjustements for OP-functions.

For each line of a menu-page information-menus are shown.

8.1. Stack Info

If a non-defined error happens while the CamCon is in operation, the user is able to controll the stack-variables' allocation which helps the software developers detection of effects. Use to stack-information-menu for this purpose.

```
Info: Stack
Taskname : main
Stacksize : 00001800
Stacktop : 9011103E
Used Stack : 000003D6
Free Stack : 0000142A
Used Stack : 15%
```

Please note the information shown on screen. At the moment, we are able to show a maximum of 6 stack-informnation menus. Please note their content and send it by fax to. +49/6126/945342.

Note: Using a CamCon DC16; 40; 50/51 and DC90 only 4 stack-menus are shown. these are called **iotask**, **rs232task**, **dc40task** and **main** A CamCon DC 115 also shows tasks called **DC115_0**, **DC115_1**; a CamCon DC300 also shows **DC300**.

9. Error messages and removal of errors (FAQ)

The error messages appear on the standard display or in CamCon DC16, 90, 115, 300 and 1756-DICAM without a display of their own through the status LED or status bits. See Chapter 4.13.1. Status LED on page 26.

The drawing below shows the error message appearing for 'Position - Error 3'.



The display for other errors is almost the same.

9.1 Problem: Display shows "No contact to unit: XX".

Possible causes:

The wiring is probably not correct, no device with the selected unit number is on the BUS or the setting of the 'Ser.Mode' is wrong.

Solution:

Check the wiring and the configuration of the serial interface.

See chapter "4.6. Terminal connections of the serial RS485 interface" on page 18 and chapter "7.5.3. Unit configuration" on page 71.

9.2. Problem: "Pos - Err:1".

Possible causes:

The measuring system has not been correctly connected.

Solution:

Please check the wiring to the measuring system. Please consult the instruction manual to the measuring system.

If the error is eliminated, the error-message can be deleted by pressing

9.3. Problem: "Pos - Err:2".

Possible causes:

The measuring system is faulty or not connected.

The setting of the error bits in the special measuring system setting is not correct.

Solution:

Check the wiring to the measuring system.

Check the inputs of the measuring system resolution.

Consult the instruction manual of your measuring system.

If the error is eliminated, the error-message can be deleted by pressing

9.4. Problem: "Pos - Err:3".

Possible causes:

The resolution of the connected measuring system is not in accord with the input resolution. The measuring system is faulty. The actual value is outside the range which was entered in the menu path setting for linear systems. See Chapter "7.4.2.2. Measuring offset with a linear moved system" on page 57. If an incremental measuring system is set, then this report is an alternative for the message "Clear...".

Solution:

Check the input of the measuring system setting and the cable length setting.
Consult the instruction manual of your measuring system.
Consult Chapter "**Problem: Clear...**".

If the error is eliminated, the error-message can be deleted by pressing .

9.5. Problem: "Pos - Err:5".

Possible causes:

The measuring system control is activated. The CamCon has registered a large unacceptable actual value jump. The measuring system is possibly faulty.

Solution:

Check the input of the measuring system setting and of the setting of the cable length or increase the permitted actual value jump. Consult Chapter "7.4.1.3. Controlling the measuring system" on page 48. Consult the instruction manual of your measuring system.

If the error is eliminated, the error-message can be deleted by pressing .

9.6. Problem: An "Pos-Error:" occurs during operation.

The monitor displays "Pos-Err:1", "Pos-Err:2", "Pos-Err:3" or "Pos-Err:5".

Possible causes:

The connection cable of the measuring system or the measuring system itself is defective. A cable without screening or without dual strand was used. The laying of a connection cable in the vicinity of a strong electromagnetic source of interference (e.g. high voltage cable, motor cable) can lead to an pos error.

Solution:

Check the wiring to the measuring system. Replace the measuring system.
Take measures for screening.
Lay the connection lead in another location.
Consult the instruction manual of your measuring system.

If the error is eliminated, the error-message can be deleted by pressing .

9.7. Problem: "RAM-Full" = RAM memory is full.

Possible causes:

The resolution of the measuring system is too large.
The number of outputs is too high.
The number of Speed Compensated outputs is too high.

Solution:

Check the input of the measuring system setting.
Reduce the measuring system resolution.
Reduce the number of Speed Compensated outputs.

Please contact your customer service representative if you require a RAM memory extension.

9.8. Problem: The EEPROM memory is full.

Cause:

Too little memory space available in the EEPROM for the storage process.

Solution:

Please contact your customer service representative if you require an EEPROM storage extension. Also consult Chapter "11. Calculation EEPROM cam storage on page 86.

9.9. Problem: Outputs will not activate

Possible causes:

An error message is active. The outputs are not connected to power supply. A programmed Cam is to short or gets to short by increasing rotation speed. The enable - Input is not set.

The outputs of the DC300 are not yet enable by the S7.

At an IM153 device the outputs 33-48 may not be enabled by the S7.

The control inputs of the CamCon are blocked by an S5 via the S5-L1 interface.

Solution:

Check the error message. Program a longer Cam. A Cam with delay-time/speed-compensation must at least have the length of two steps.

Enable Outputs at the enable-Input, see also chapter 7.4.6.6. Input for enableing Outputs on page 65

Enable the outputs through the S7 PLC. See chapter 13. Communication between S7 and CamCon DC300 on page 88 and chapter 13.5. FC51 - I/O Copy Program on page 93.

9.10. Problem: "Out - Error".

Possible causes:

Your outputs are overloaded or short-circuited. Check the wiring and the connection output as well as possible inductive loads which have no zero setting or are driven by a cancellation component.

The number of set inputs is not correct.

Power failure at an external interface module (e.g. DC91/IO or DC16/IO).

Solution:

See chapter "4.10. The outputs" on page 25.

See chapter "7.4.6. System upgrading" on page 65.

See chapter "7.5.6. Configure Hardware" on page 77.

If the error is eliminated, the error-message can be deleted by pressing 
Here the attempt to reset outputs is done

Warning: *Wires crossing behind the outputs, if the cables leading towards the switch-OFF of the outputs are in an awkward position, can lead to a switch-OFF of the outputs, since in an open situation a potential is built up which, when the contacts are closed, is led back into the outputs.*



In inductive loads the outputs must be organised with a flywheeling diode. Protection or induction in the switch cabinet in the immediate vicinity of the device or due to their wiring have an effect on the device or its wiring and must be organised with cancellation components.

9.11. Problem: Error in the EEPROM.



Possible causes:

The data of the EEPROM was changed or destroyed by interference.

One of the existing data carriers (EEPROM or EPROM) was renewed or is defective.

The power supply was switched OFF during alteration of the data.

Solution:

Press  for yes and then the  key. All data will be erased and must be re-entered. Should these errors occur repeatedly, please contact your customer service.

9.12. Problem: "Error ???"

Possible causes:

An unpredictable error has occurred.

Solution:

Please contact your customer service.

9.13. Problem: "Clear...."

Cause:

The CamCon is waiting for the arrival of the Clear signal in an incremental measuring system.

Solution:

Set the Clear signal ON or activate an actual value Preset. The result is the immediate release of the Cam Switch Unit.

Note: The incremental measuring system is only available as an option for CamCon DC16, DC50/51, DC115, DC300 and CamCon 1756-DICAM.

See chapter "7.4.1.6.3. Incremental - measuring system" on page 51.

9.14. Problem: The S7 CPU goes into Stop or invokes OB121.

Possible Causes:

The structure of the data component is incorrect (cycle time overflow or access error in the DB).

The overall current consumption of the sub-rack from the S7 CPU is too large.

A process interrupt through an edge on output 1 of the CamCon does not find the OB40.

Solution:

Check the structure of the data DBs also with respect to the data.

Apportion the sub-rack to several lines through the IM modules.

Set up the OB40 (interrupt) or switch of the process-alert-function at the DC300.

See also chapter "7.5.3.5. Process alert respective Interruptfunktion" on page 75.

9.15. Problem: The S7 CPU does not go into RUN

Possible Causes:

The base address of the subassembly is not correct (peripheral equipment access error).

The revision of the S7 CPU firmware has been changed.

You are using a parametering software of the FM352 subassembly installed at your Step 7 - software.

You are using an error proof F-subassembly and have set the CamCon DC300 between the F - CPU and an F - subassembly.

You are using an S7-300 CPU with extended I/O range (>256 I/O Byte).

Solution:

Check the base address in the Step7 hardware definition.

Change at the hardwaredefinition the FM subassembly's type on No.: "6ES7 352-1AH01-0AE0".

Set the FM-subassembly to "FM 351 FIX. SPEED" = order No.: "6ES7 351-1AH00-0AE0".

Build up the DC300 at an error proof F - CPU at the subassembly carrier's end.

The DC300 does not support the extended E/A range, please switch it off.

Please contact your after-sales service.

10. Menu outline

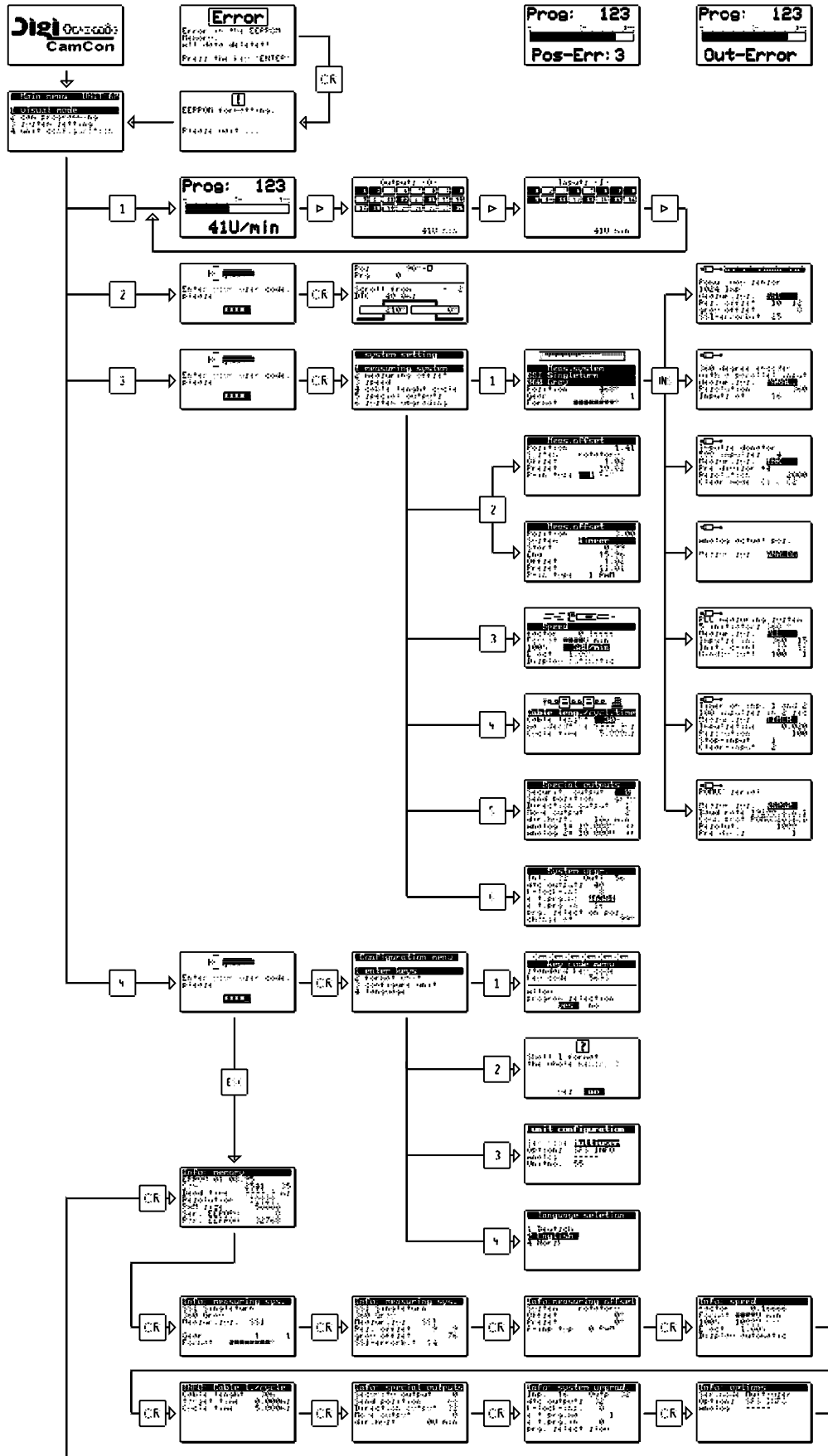

11. Calculation EEPROM cam storage

In the CamCon you have the opportunity to extend the **EEPROM** Cam storage. The storage space required for programming is influenced by the following factors:

- | | |
|--|-------------|
| 1. Basic requirement | = 256 Bytes |
| 2. Per cam | = 12 Bytes |
| 3. Per set delay time for Speed Compensation | = 12 Bytes |
| 4. Per name for an output | = 24 Bytes |
| 5. Per set key / code | = 66 Bytes |
| 6. For a special measuring system | = 66 Bytes |
| 7. For direct or "actual" program selection | = 12 Bytes |
| 8. Per set program name | = 48 Bytes |
| 9. Per line of the OP function | = 72 Bytes |

The value is generated by the CamCon with the following formula:

Storage requirements in Bytes	=	Basic needs
	+	Number of cams * 12
	+	Number of delay times for Speed Compensation * 12
	+	Number of output names * 24
	+	Number of user keys * 66
	+	66 when the special measuring system is available.
	+	12 when "on Pos" program selection is set.
	+	48 * number of set program names.
	+	72 * number of set lines of the OP function.

Example 1: The Cam Switch Unit is supposed to have 8 Programs each with 16 cams and Speed Compensation for 16 outputs.

Storage requirement in Bytes = 256 Bytes + (8 Programs * 16 * 12 Bytes) + (16 * 12 Bytes)

Storage requirement = 1984 Bytes

Example 2: The Cam Switch Unit is supposed to have 20 programs each with 16 cams and 16 delay times for Speed Compensation.

Storage requirement in Bytes	=	256 Bytes
	+	(20 Programs * 16 * 12 Bytes)
	+	(16 TZK * 12 Bytes)
	+	(16 Output names * 24 Bytes)
	+	(1 User keys * 66 Bytes)

Storage requirement = 4738 Bytes

Warning: Through alterations in the storage structure of the CamCon software, the extent to which storage capacity is used up can differ from software version to software version!

12. Calculation the RAM storage-requirement for CamCon

The required **RAM**-main storage (not similar to the constant value - Camstorage or the EEPROM) depends on 7 factors:

- | | |
|---|--|
| 1. Standard consumption | (approximately 100000 Byte) |
| 2. Number of outputs | (8 to 200 in steps of 8 outputs). |
| 3. Cycle time | (displayed in milliseconds). |
| 4. Actual value/measuring system resolution | (displayed in impulses) |
| 5. Maximal Speed-compensation | (0 to 9999.9 in steps of 100 microseconds). |
| 6. Mode of program selection | (the double amount of storage is required).
(See also chapter "7.4.6.8. Setting the program selection mode" on page 66). |
| 7. Size of the EE-Prom storage | (EE-Prom - storage size in Byte for Cache). |

The RAM - storage requirement is calculated by the following formula:

$$\text{storage requirement in Bytes} = \text{standard consumption} + \frac{\text{Number of outputs} * \text{Actual value resolution} * (2 \text{ If program Mode not slow})}{8} + \frac{\text{max. delay-time} * 4}{\text{cycletime}} + \text{EE-Prom size}$$

Example 1: The camswitch with a resolution of 360°, an EE-Promstorage of 32kByte, 16 outputs, a speed-compensation of 1000ms and a cycletime of 250µs needs:

$$\text{Storage requirement in Bytes} = 100000 + \frac{16 * 360}{8} + \frac{1000 * 4}{0.250} + 32768$$

$$\text{Storage requirement in Bytes} = 100000 + 720 + 16000 + 32768$$

$$\text{Storage requirement in Bytes} = 149488 = \text{ca. } 150\text{kByte}$$

Example 2: The camswitch with a resolution of 8192°, an EE-Promstorage of 48kByte, 64 outputs, a speed-compensation of 500ms and a cycletime of 250µs, needs:

$$\text{Storage requirement in Bytes} = 100000 + \frac{64 * 8182}{8} + \frac{500 * 4}{0.250} + 49152$$

$$\text{Storage requirement in Bytes} = 100000 + 65536 + 8000 + 49152$$

$$\text{Storage requirement in Bytes} = 222688 = \text{ca. } 220\text{kByte}$$

Note: If the required RAM - storage requirement greater than the CamCons total amount of storage, you need to reduce the measuring system's resolution.

Attention: Changings in the storage-structure of the CamCon software the storage requirement can alternate at different software-versions!

13. Communication between S7 and CamCon DC300

The communication between the S7 CPU and the CamCon DC300 is handled through the backplane bus of the S7. For this purpose, you need a function block, which you may obtain under Order No.:DC300/HB-S7. Required at the S7 are 10kB of working storage and 13kB of loading storage.

Attention: If parameter, Cams or delay-times are written or programmed cyclically the EEPROM data storage will be deleted shortly after.

13.1. Installation of the S7 Software

In an S7 Project V5, the software is on a diskette, which must be dearchived for installation. The project name is "DC300". You may verify the software version in the block header of the OB1 or FB51.

- After dearchiving, open the "DC300" project and copy the blocks FB51, FC51,52,53,54,55, DB50 and DB61 from the "DC300" project into your application.
- Copy the network 1 of the OB100 from the "DC300" project into the OB100 of your application.
- Set up the OB40 for process interrupt processing. For reference, please see the example network in the OB40.
- Change the block parameter when invoking FB51 in your entire program (OB100 and the main call) to your desired parameter.
- define the data block DB50.
The data was summarized in structures for a better overview.
- determine the number of the administered outputs (cam tables) and enter them in the OB100 in the DB50. DBW36.
- Define the cams table in the DB50 (please refer to Chapter "13.9.2. DBxx range 2 = Cams table" on page 95 and the example in the DC300 project). The storage location for the output number, the number of cams, and the activation or deactivation points must be available for each output. There should be no gaps or overlaps. If an output is not in the table, it is deleted in CamCon in a programming command. A maximum of 13 cams can be programmed for each output.
- Define the delay time table in the DB50 (please refer to the chapter "13.9.3. DBxx range 3 = Delay Times" on page 95 and to the example in the DC300 project). One data element for each output.
- Enter the cams and delay time values in the table.
- Define the RK512 command table. The RK512 commands are used to parameterize the CamCon DC300 (please refer to the chapter "13.9.4. DBxx range 4 = RK512 Table" on page 96 and to the example in the DC300 project). For example, it is possible to change the zero offset or the direction of rotation of the CamCon. Again, there should be no gaps or overlaps.
- Enter in the DB50 the starting points (data word number) of the cam, delay time and RK512 table in the OB100. The position of the cams table is in the DW0, that of the delay time in the DW2 and that of the RK512 table is in the DW4.

13.2. Required Blocks and Networks

The following blocks or networks are necessary for operating the software:

FB51	main program.	
FC51	reloading program for the outputs and the release.	
FC52	evaluation of received data	(Subroutine of FB51).
FC53	structure of the transmittal data	(Subroutine of FB51).
FC54	sending the data to the DC300 via the S7 BUS	(Subroutine of FB51).
FC55	receiving the data from the DC300 via the S7 BUS	(Subroutine of FB51).
DBxx	entity DB for FB51.	
DBxx	DB for cams - , delay time - RK512 - and status data.	
OB1	one network each for invoking the FB51 and FC51.	
OB40	for process interrupt processing, the invocation takes place through an edge at output 1 of the CamCon DC300.	
OB100	a network for initializing the software (DB50).	

13.3. OB1

Most of the networks of the OB1 are intended as examples for testing the software and may be deleted or revised. The networks with the FB51 and FC51 invocation must, however, be cyclically invoked. The parameters (markers, timers and data blocks) of these two can be adjusted to the conventions of the application, but must also be changed in the OB100 (Startup OB)!

13.4. FB51 - Main Module

The FB51 is the main module of the software and must be invoked cyclically in the OB1. The FB51 and the communication are released through the ENABLE Bit 0.0 in the parameter word IN_COMMANDS. If the FB is blocked since no data should be read or programmed (cams, delay times, etc.), about 3 ms cycle time can be saved in a CPU 315/DP.

Note: If the ENABLE Bit 0.0 is reset, the last command still in progress is still terminated.

Note: If the ENABLE Bit 0.0 is not set, the command bits from FB51 are immediately reset without a command being triggered.

The communication to the cam control mechanism is started by the release of the FB51. If there are no commands, a status query (command 0x01) is sent to the CamCon and the data received by the CamCon is stored in the DB data. Please refer to the chapter "13.9. DBxx - Data block for cam data" on page 94.

The status information that has been read is evaluated through the FB51.

First, it is examined whether an error was entered in the status byte (DB16) of the cam control mechanism. If this is the case, an error reset (command 0x02) is automatically sent to the CamCon cam control mechanism.

Subsequently, the current program number (DW14) is compared with the desired program number (DW26). If these are not the same, a program change (command 0x03) is sent with the requested program number. This means that, to change the program, it is enough to specify the data word 26 with the desired number.

It is now verified whether a command for cams - , delay time, or RK512 programming or for Cams - , delay time, or RK512 read should be started. This is controlled by setting the bits in the parameter word IN_COMMANDS. The data for the appropriate commands must first be entered in the data DB. In this connection, refer to the next chapter. If the command was executed without error, the error bit is reset through the FB51.

Important: The status information of the communication and of the CamCon cam control mechanism is stored in the STATUS_OUT word of the FB51. These should be evaluated in the user program, and in case of error, lead to a disconnection of the automatic functions of your machine and to an error message.



13.4.1. Parameter of the FB51

1. Instance DB = Static data of FB51. This DB must be set up in the S7 software (offline) by inserting the FB51 in the OB1.
2. ADR = Base address of the DC300 in the S7 BUS, e.g. 256. If this address is not correct, the S7 CPU with peripheral equipment access error goes into Stop mode or the OB121, if available, is activated.
3. DATE_DB = Number of the data block, in which the data will be filed.
The DB must be set up and initialized.
4. TIMER_TIMEOUT = number of a duration which is used internally for timeout monitoring (e.g., 0).
5. STATUS_OUT = Flag word, in which the status of the CamCon is stored (e.g., MW0).

Bit 0.0 = ERROR = DC300 has an error message

Note: This bit is also specified if the FB51 does not have a release (ENABLE). As a result, it is possible to save about 3 ms cycle time through the communication and nevertheless recognize an error message of the DC300.

Bit 0.1 = INIT = DC300 connected and started.
Bit 0.2 = BEF_IA = Command in process.
Bit 0.3 = BEFERR = Error when sending a command, e.g., memory of the CamCon is full.
Bit 0.4 = TIMEOUT = A timeout occurred during data transmission. An attempt is made to resend the command.
Bit 0.5 = res = Currently not used.
Bit 0.6 = res = Currently not used.
Bit 0.7 = res = Currently not used.
Bit 1.0 = ISTERR1 = CamCon reports actual value Error 1.
Bit 1.1 = ISTERR2 = CamCon reports actual value Error 2.
Bit 1.2 = ISTERR3 = CamCon reports actual value Error 3 or Clear for incremental transmitter.
Bit 1.3 = AUSERR = CamCon reports output error.
Bit 1.4 = ISTERR5 = CamCon reports actual value Error 5.
Bit 1.5 = UNBEKA = Error message of CamCon unknown.

Note: The error messages 1.0 to 1.5 try to automatically quit the program.

Bit 1.6 = EE-Error = Error message EE-Prom.
The checksum in the EE-Prom memory is not OK. Execute the RK512 command [”delete all”].
Bit 1.7 = res = Currently not used.

6. IN_BEFEHLE = Flag word, in which the commands (bits) must be set by the application program (e.g., MW2). If a command is executed, this bit is reset. If a read command is completed, the values of the cams, delay time, or RK512 that have been read are in the DB.

Bit 0.0 = ENABLE = release FB and ask about status.

Note: If this bit is reset, the last command still in progress is still terminated.

Note: If this bit is not set, the following command bits are immediately reset by FB51 without a command being triggered.

Bit 0.1 = RESET = The entire communication is reset with the increasing edge and a restart is attempted.

Bit 0.2 = NP	=	Program a cam. The data for this must already be in the DB. 1. Offset on cams table (DW 0). 2. Program number (DW 38). 3. Output number (DB 40). 4. Cams table starting from data word = offset in DW 0. 5. Activation and deactivation points.
Bit 0.3 = NAP	=	Program all cams. The data for this must already be in the DB. 1. Offset on cams table (DW 0). 2. Program number (DW 38). 3. Administered output number (DW 36). 4. Cams table starting from data word = offset in DW 0. 5. Activation and deactivation points.
Bit 0.4 = NL	=	Read a cams. The data for this must already be in the DB. 1. Offset on cams table (DW 0). 2. Program number (DW 38). 3. Output number (DB 40). The cams that have been read are in the table starting from data word = offset in DW 0.
Bit 0.5 = NAL	=	Read all cams. The data for this must already be in the DB. 1. Offset on cams table (DW 0). 2. Program number (DW 38). 3. Administered output number (DW 36). The cams that have been read are in the table starting from data word = offset in DW 0.
Bit 0.6 = TP	=	Program a delay time. The data for this must already be in the DB. 1. Offset on delay time table (DW 2). 2. Output number (DB 40). 3. Delay time value in 0.1ms steps in the table starting from data word = offset in DW 2.
Bit 0.7 = TAP	=	Program all delay times. The data for this must already be in the DB. 1. Offset on delay time table (DW 2). 2. Administered output number (DW 36). 3. Delay time value in 0.1ms steps in the table starting from data word = offset in DW 2.
Bit 1.0 = TL	=	Read a delay time. The data for this must already be in the DB. 1. Offset on delay time table (DW 2). 2. Output number (DW 40). The delay time read is in the table starting from data word = offset in DW 2.
Bit 1.1 = TAL	=	Read all delay times. The data for this must already be in the DB. 1. Offset on delay time table (DW 2). 2. Administered output number (DW 36). The delay times read are in the table starting from data word = offset in DW 2.

Bit 1.2 =	PRK	=	Program an RK512 data record. The data for this must already be in the DB. 1. Offset on RK512 table (DW 4). 2. Data record number = 1.DW of RK512 table (DW 4). 3. The data of the table to be written with DB no., DB offset and the data.
Bit 1.3 =	LRK	=	Read an RK512 data record. The data for this must already be in the DB. 1. Offset on RK512 table (DW 4). 2. Data record number = 1.DW of RK512 table (DW 4). 3. The data of the table to be read with DB no. and DB offset. The data read are in the RK512 table starting from data word = offset in DW 4.
Bit 1.4 =	PARK	=	Program all RK512 data records. The data for this must already be in the DB. 1. Offset on RK512 table (DW 4). 2. All the data of the table to be written with DB no., DB offset and the data.
Bit 1.5 =	LARK	=	Read all RK512 data records. The data for this must already be in the DB. 1. Offset on RK512 table (DW 4). The data read are in the RK512 table starting from data word = offset in DW 4.
Bit 1.6 =	res	=	Currently not used.
Bit 1.7 =	res	=	Currently not used.

13.5. FC51 - I/O Copy Program

Since the CamCon DC300 modules on the S7 BUS can allocate only peripheral addresses and not E/A addresses, the FC51 copies the status of the DC300 outputs and its release through two ANY pointers from the peripheral range into the user program and back again. The FC51 requires about 1.2 ms cycle time for a CPU 315/DP.

Note: The FC51 copies the data of the DC300 directly (high-speed I/O). This way, you yourself have the capability, by invoking this FC in the OB1 several times, to bring the response time of the S7 SPS under that of the cycle time of the SPS.

The parameters of the FC51 are:

1. BASADR = Base address of the DC300 in the S7 BUS, e.g., 256. If this address is not correct, the S7 CPU with peripheral equipment access error goes into Stop or the OB121, if available, is activated.
2. OUTPUT = This parameter is an ANY pointer, which points to the range to which the status of the DC300 outputs is copied. A maximum of 8 bytes can be copied, and the range, through the ANY pointer, may be as desired (e.g., P#M10.0 BYTE 3).
3. RELEASE = This parameter is an ANY pointer, which points to a range that releases the outputs of the DC300. A maximum of 8 bytes can be copied, and the range, through the ANY pointer, may be as desired (e.g., P#M13.0 BYTE 3).

Tip: The release bits are linked with the AND gate (output disconnection). In a connected SPS logic module, the release bits are made available to the SPS logic module as V-inputs. Please see the manual of the SPS Logic Module concerning this (order no.: H-SPS).

13.6. FC52, 53, 54 and 55 - Subroutines of FB51

These FC blocks are invoked through the FB51 and may not be invoked from another location.

13.7. OB100 - Startup block

The data DB is initialized and the communication is reset in this OB.

13.8. OB40 - Process Interrupt Function or Interrupt Function

Starting with software version DC300.6 dated June 20, 2000, the CamCon DC300 will support the process interrupt function or the interrupt function of the S7 300. See also chapter "7.5.3.5. Process alert respective Interruptfunktion" on page 75

A process interrupt is always triggered with an edge at Output 1 of the CamCon DC300. The S7 program is interrupted in a positive as well as a negative edge and branched off into the OB40.

Here, verify the variable "OB40_MDL_ADDR" of the OB40 for sameness of base address of the DC300 in order to determine whether the interrupt was triggered by the cam control mechanism. If this is the case, you may now execute the desired function.

13.9. DBxx - Data block for cam data

The cam, delay time, or RK512 parameter data are stored in a data block, which is delivered to the FB51 as parameter. Data, such as actual value, speed, output status, status of the cam control mechanism, current program number and desired program number are also stored in this data. The DB is subdivided into 4 ranges: 1.Status, 2.Cams, 3.Delay times and 4.RK512 parameter. The position of these ranges, with the exception of the status range, is stored as offset in the first three data words.

TIP: This DB can also be created with the Windows programming-software DIGISOFT 2000, V2.19 or alter by data export. By this, all parameter and networks of the CamCon PLC-logic-module be saved in the S7, so that in case of exchange only the DC300 has to be changed and the RK512 - parameter-sheet must be re-written.

13.9.1. DBxx range 1 = Status

DW 0	OFFSET	Offset for range 2 = cams data.	
DW 2	OFFSET	Offset for range 3 = delay times.	
DW 4	OFFSET	Offset for range 4 = RK512 data or parameter data.	
DW 6	res	Reserve.	
DW 8	res	Reserve.	
DW 10	ACTUAL VALUE	current actual value	(only reading possible).
DW 12	SPEED	current speed value	(only reading possible).
DW 14	PROG	current program number	(only reading possible).
DB 16	NSWSTATUS	NSW Status	(only reading possible).
DB 17	AUSANZIST	number of outputs of the CamCon	(only reading possible).
DW 18	AUSSTAT1	Status Outputs 1-16	(only reading possible).
DW 20	AUSSTAT2	Status Outputs 17-32	(only reading possible).
DW 22	res	Reserve.	
DW 24	res	Reserve.	
DW 26	GPROG	desired program number	(only writing possible).
DW 28	res	Reserve.	
DW 30	res	Reserve.	
DW 32	res	Reserve.	
DW 34	res	Reserve.	
DW 36	AUSANZV	Administered output number	(only writing possible).
DW 38	PROGPRG	Program for programming	(only writing possible).
DB 40	AUSGNR	Current output number	(only writing possible).
DB 41	res	Reserve.	

The data words DW10 to 20 are filled by the response to a status query.

If the data words 16 and 26 are different, a program change command is sent to the CamCon. This means that to change the program, it is enough to specify the DW26 with the desired number.

The number of the administered outputs for cam and delay times must be entered in DW36. In the OB100, this is done at every start.

When reading or programming cams or delay times, the data word DW38 and the data byte DB40 must be adjusted to the desired program and output number before the release of the command bit.

13.9.2. DBxx range 2 = Cams table

The offset pointer (DW0) of the DB data must point to the starting point of the cams table, which is supposed to be used to read or program the cams. You have the opportunity to store several tables in the data DB, and by changing the DW0, to send another program to the cam control mechanism.

Important: The offset may only be changed if there is no cam command active.

The cams table is divided into structures, with the table itself representing a structure and each cam track (output) representing a sub-structure. A cams table has the following structure: At the start, there is always an output number (byte) for identification, then the number of cams (byte) for the output (currently a maximum of 13), and then the data words with the activation and deactivation points. If the number of cams is set to 2, a total of 4 data words (DW) **must** follow before a new output number may follow. The program now searches the table starting from the first output number until it has found the desired output number and then programs or reads its cam.

A data word with the content FFFF must be attached to the end of the cams so that the program can recognize the end of the table.

xx = Offset from DW0

DBxx + 0	AUSG_NR	= e.g., 1	1 st output number.
DBxx + 1	ANZ_NOCKEN	= e.g., 2	number of cams for this output.
DWxx + 2	EIN_0001	= Cam value	activation point 1.
DWxx + 4	AUS_0001	= Cam value	deactivation point 1.
DWxx + 6	EIN_0002	= Cam value	activation point 2.
DWxx + 8	AUS_0001	= Cam value	deactivation point 2.
DBxx + 10	AUSG_NR	= e.g., 2	next output number.
DBxx + 11	ANZ_NOCKEN	= e.g., 1	number of cams for this output.
DWxx + 12	EIN_0001	= Cam value	activation point 1.
DWxx + 14	AUS_0001	= Cam value	deactivation point 1.
DWxx + 16	ENDE	= FFFF	end identifier.

The table described above would program or read two cams for output number 1 and one cam for output number 2.

Important: No gaps or overlaps may emerge in the definition in the structure or the S7 CPU will otherwise go into Stop or will invoke the OB121 with cycle time overflow or access error in the DB.

13.9.3. DBxx range 3 = Delay Times

The offset pointer (DW2) of the DB data must point to the starting point of the delay time table, which is supposed to be used to read or program the delay times. If the DW2 is set to 0, no delay time may be relayed.

A delay time table has the following structure:

DWxx = Offset from DW2			
DWxx + 0	TZK1	= e.g., 10	Delay time for output 1 (10 => 1.0ms).
DWxx + 2	TZK2	= e.g., 15	Delay time for output 2.
"	"	"	"
DWxx + 62	TZK32	= e.g., 0	Delay time for output 32.

Important: A data word (DW) must be defined for each administered output.

13.9.4. DBxx range 4 = RK512 Table

The electronic cam control mechanisms of the CamCon series of the company DIGITRONIC Automationsanlagen GmbH support the RK512 computer link procedure. In this case, the CamCon simulates an SPS control and provides its data (parameter, status, cams and delay times) in data blocks as data - double - words. The data records, which set the access to the parameters, are now stored in the RK512 table.

The offset pointer (DW4) of the DB data must point to the starting point of the RK512 table, which is used to read or program parameters. If the DW4 is set to 0, no parameters may be relayed.

The RK512 table is divided into structures, with the table itself representing a structure and each parameter data record representing a sub-structure. The RK512 table has the following format: At the start, there is always a current data record number (DW), which is being processed or is supposed to be processed. The identification character of the 1st data record through the data record number (DW) follows. Afterwards, the number (byte) (currently a maximum of 11) of the data-double-words that are defined in the data record. The next two bits (DBxx.DBy.z) determine whether the data record may be read and/or written. Then a byte for the simulated DB number and a byte for the offset in the DB of the DC300 follow. Then the exact number of data-double-words that were previously defined. The identification character for the next data record can follow after this. Starting with the first data record, the program searches the table until the desired data record has been found, and then programs or reads its data. A data word with the content FFFF must be attached to the end of the RK512 table so that the program can recognize the end of the table.

Important: No gaps or overlaps may emerge in the definition in the structure or the S7 CPU will otherwise go into Stop or will invoke the OB121 with cycle time overflow or access error in the DB

xx = Offset from DW4

DWxx + 0	RK_AKT_SATZ	= e.g., 1	current data record
DWxx + 2	RK_SATZ_NR	= e.g., 0	identification character for first data record.
DBxx + 4	RK_DATA_LEN	= 4	Number of data - double - words (max.11).
DXxx + 5.0	RK_DATA_L	= TRUE	Read data record on or off.
DXxx + 5.1	RK_DATA_P	= FALSE	Write data record on or off.
DBxx + 6	RK_DBNR	= 203	DB no. in the CamCon.
DBxx + 7	RK_DBOFFSET	= 1	Offset in the DB starting at which there is data.
DDxx + 8	WERT_00	= Wert	1 st value of the data.
DDxx + 12	WERT_01	= Wert	2 nd value of the data.
DDxx + 16	WERT_02	= Wert	3 rd value of the data.
DDxx + 20	WERT_03	= Wert	4 th value of the data.
DWxx + 24	RK_SATZ_NR	= e.g., 0	Identification character for the next data record.
DBxx + 26	RK_DATA_LEN	= 2	Number of data - double - words (max.11).
DXxx + 27.0	RK_DATA_L	= FALSE	read data record on or off.
DXxx + 27.1	RK_DATA_P	= TRUE	Write data record on or off.
DBxx + 28	RK_DBNR	= 204	DB no. in the CamCon.
DBxx + 29	RK_DBOFFSET	= 15	Offset in the DB starting at which there is data.
DDxx + 30	WERT_00	= Wert	1 st value of the data.
DDxx + 34	WERT_01	= Wert	2 nd value of the data.
DWxx + 38	ENDE	= FFFF	End identifier.

The above described table would read out the RK512 data record 0 from the CamCon DB203 starting at offset 1. The programming of the data record would not be allowed and would return an error message. The second data record can program only 2 values in the DB 204 starting at offset 15. The reading of the second data record would not be allowed and would return an error message.

Note: For the definition of the DC300 data blocks, please see chapter "15.8. RK512 " on page 102 and the example in the DC300 project.

13.10. High-speed Actual Value and Speed Value Transmission

The CamCon cam control mechanism has the capability to provide the actual value and the speed value of the S7 SPS as a peripheral input word.

Note: The integrated analog outputs must be switched off.

To do this, use the CamCon menu "System setup ", go to the submenu "special outputs", and set the actual value output to "Bin." and the speed analog to "yes".

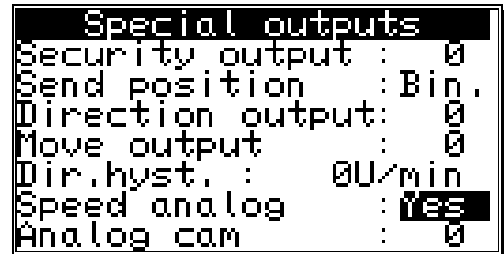

The cam control mechanism now sends the speed and the actual value to the peripheral range of the PLC directly through the S7 BUS. Through the FC51, the peripheral range is copied, e.g., into a flag area, and can be processed further. In the process, it must be noted that 1x16Bit speed and 1x16Bit actual value are read out additionally as outputs. Since only a maximum of 8 bytes can be handled by the FC5 in the DC300 as I/O transfer, the number of the set physical outputs may not exceed the value of 32.

The transmitted values, before being used in the SPS program, must still be rotated byte by byte because high- and low bytes are interchanged. In addition, the scaling of the speed value must be computed from this since this will be transmitted signed as a 15Bit value.

Note: Please see the example in OB1.

The scaling of the speed value is determined by the 100% input in the "Speed" submenu in the "System set-up" menu. This value is converted to 15Bit in the cam control mechanism. This means that at an rpm of 512, a value of 32768 is output, which must then recomputed by dividing in the SPS. To calculate the speed value through simple shift instructions, the input should be done only in binary units.

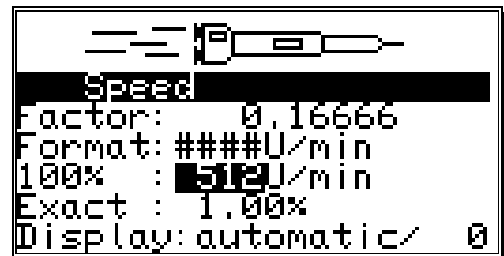

Example: For a 100% value of 512 rpm, the divisor must be 64, corresponding to a shift instruction of SRW 6.

100%	Divisor	Shift value
32	/ 1024	= 10
64	/ 512	= 9
128	/ 256	= 8
256	/ 128	= 7
512	/ 64	= 6
1024	/ 32	= 5

14. CamCon data transfer general

The CamCon sends all information on enquiry-sequences and executes commands on certain command-sequences, that are acknowledged later. The data is stored in the "Send - and receive compartment" of the PLC. A data record is built up as follows:

14.1. Question sequence

- | | |
|--------------------|--|
| 1. question mark: | '?'. |
| 2. command number: | currently 0x01, 0x04 und 0x06. |
| 3. necessary data: | a maximum of additional 62 Byte (31 data words). |

14.1.1. Answer sequence, related to questions

- | | |
|------------------------------------|--|
| 1. acknowledging mark: | ':' |
| 2. setting back a questions number | currently 0x01, 0x04 und 0x06. |
| 3. data: | a maximum of additional 62 Byte (31 data words). |

14.2. Command sequence

- | | |
|-----------------------------|--|
| 1. command sign: | '!'. |
| 2. command number: | currently 0x02, 0x03, 0x05 und 0x07. |
| 3. possibly necessary data: | a maximum of additional 62 Byte (31 data words). |

14.2.1. Command acknowledgement

- | | |
|---------------------------------|--------------------------------------|
| 1. acknowledging mark: | ':' |
| 2. setting back a orders number | currently 0x02, 0x03, 0x05 und 0x07. |
| 3. acknowledging OK: | 'OK' = 2 Byte. |

or

- | | |
|-------------------------|----------------|
| 3. acknowledging Error: | 'ER' = 2 Byte. |
|-------------------------|----------------|

14.3. Acknowledgement for unknown question or command

- | | |
|------------------------------|------|
| 1. acknowledging mark: | ':' |
| 2. sign for unknown command: | 'Z'. |

15. Possible commands

A description of all currently possible commands for CamCon camswitches follows.

15.1. Request on 0x01

Necessary data in the PLC's send-compartment, for reading the status-data of the camswitch:

1. DW 0x06 / 0x00 Length of the "send-data" / target-number must always be 0.
2. DW 0x3F / 0x01 Mark of a question-command "?" / number "1" for request on status.
3. DW 0XXXXX virtual inputs 1-16.
4. DW 0XXXXX virtual inputs 17-32 (without V-inputs the send-length is 2).
" (send-length corresponding to the number of virtual inputs).

If the length of the send-data is set to greater than 2 also data-words after DW1 (virtual inputs) will be transferred. If so, these additional data-words will be connected to the outputs **AND** and therefore cause their switching of, if the PLC demands it. If only zero-bytes are sent, all of the CamCon's outputs switch off.

As an answer the following data can be found in the receive-compartment:

1. DW 0x0C / 0x00 Length of the receive-data / sourcenum has to be 0.
2. DW 0x3A / 0x01 Acknowledging sign ":" / Number "1" for a request on status.
3. DW 0XXXXX Actual value.
4. DW 0XXXXX Speed.
5. DW 0XXXXX active program.
6. DW 0XX,0XXX CamCon status, number of outputs.
CamCon status 0 = OK / status 1-3 = "Ist-Err: 1-3" / status 4 = "Aus-Err".
7. DW 0XXXXX Output 1-16.
8. DW 0XXXXX Output 17-32.
" (Receive-length corresponding to the number of outputs).

15.2. Error-reset of the CamCon camswitch 0x02

Necessary data in the PLC's send compartment, for setting back an "I-Err:x" or "Out-Err":

1. DW 0x02 / 0x00 Length of the send-data / target number has to be 0.
2. DW 0x21 / 0x02 Command sign "!" / number "2" for error-reset.

As an answer the following data can be found in the receive compartment:

1. DW 0x04 / 0x00 Length of receive-data / sourcenum has to be 0.
2. DW 0x3A / 0x02 Acknowledging sign ":" / Number "2" for error reset.
3. DW 'O','K' "OK" = done or "ER" = error.

15.3. Programmchange of the CamCon camswitch 0x03

Necessary data in the PLC's send compartment for the change of program number.

1. DW 0x04 / 0x00 Length of the send-data / target number has to be 0.
2. DW 0x21 / 0x03 Command sign "!" / number "2" for program change.
3. DW 0XXXXX new programming.

As an answer the following data can be found in the receive-compartment:

1. DW 0x04 / 0x00 Length of receiving data / sourcenum must always be 0.
2. DW 0x3A / 0x03 Acknowledging sign ":" / number "3" for program change..
3. DW 'O','K' "OK" = done or "ER" = error.

15.4. Reading a CamCon camswitches' camtrack 0x04

Required data in the send-compartment for reading of a camtrack.

1. DW 0x06 / 0x00 Length of the send-data / target number has to be 0.
2. DW 0x3F / 0x04 Mark of a question-command "?" / number "4" for reading Cams.
3. DW 0XXXX Programnumber.
4. DW 0xXX / 0x00 outputnumber/empty Byte.

As an answer the following data can be found in the receive compartment:

1. DW 0xXX / 0x00 Length of the receive-data / sourcenummer has to be 0.
2. DW 0x3A / 0x04 Acknowledgeing sign ":" / number "4" for reading Cams.
3. DW 0XXXX Programnumber.
4. DW 0xXX / 0xXX Output number, number of Cams.
5. DW 0XXXX Switching on point 1. Cam.
6. DW 0XXXX Switching off point 1. Cam.
7. DW 0XXXX Switching on point 2. Cam.
8. DW 0XXXX Switching on point 2. Cam.
" (Receive length corresponding to Cams at the output).

15.5. Programing the Cam-track of a CamCon camswitch 0x05

Required data in the send-compartment for programing of a camtrack.

1. DW 0x16 / 0x00 Length of the send-data / targetnumber has to be 0.
2. DW 0x21 / 0x05 Sign for command "!" / Number "5" for cam-programing.
3. DW 0XXXX Programnumber.
4. DW 0x01 / 0x01 Output number / Number of Cams for output 1.
5. DW 0XXXX Switching on point for Cam output 1
6. DW 0XXXX Switching off point for Cam output 1
7. DW 0x02 / 0x02 Output number, number of Cams for output 2.
8. DW 0XXXX Switching on point for 1st Cam output 2
9. DW 0XXXX Switching off point for 1st Cam output 2
10. DW 0XXXX Switching on point for 2nd Cam output 2
11. DW 0XXXX Switching off point for 2nd Cam output 2
12. DW 0xFFFF End detection must be FFFF.
" (Sende length corresponds to number of Cams).

Note: All Cams which have ben programed for an output before, will be deleted. This results in a maximum number of 14 programable Cams per output.

As an answer the following data can be found in the receive compartment:

1. DW 0x04 / 0x00 Length of receive-data / sourcenummer has to be 0.
2. DW 0x3A / 0x05 Acknowledgeing sign ":" / number 4 for programing Cams.
3. DW 'O','K' "OK" = done or "ER" = error.

15.6. Reading the CamCon camswitches' delay time 0x06

Required data in the send-compartment of the PLC for to read a delay-time:

1. DW 0x04 / 0x00 Length of send-data / targetnumber must always be 0.
2. DW 0x3F / 0x06 Mark of a question-command "?" / number "6" for reading delay-times.
3. DW 0xXX / 0x00 Output number / empty Byte

As an answer the following data can be found in the recieve compartment:

1. DW 0x06 / 0x00 Length of recieve-data / sourcenumbr must always be 0.
2. DW 0x3A / 0x06 Acknowledgeing sign ":" / number 6 for reading delay-times.
3. DW 0xXX / 0xXX Output number / empty Byte
4. DW 0XXXXX Delay-time in 100us steps.

15.7. Programming a CamCon camswitches' delay time 0x07

Required data in the send-compartment of the PLC for to program a delay-time:

1. DW 0x06 / 0x00 Length of send-data / targetnumber must always be 0.
2. DW 0x21 / 0x07 Sign for command "!" / Number "7" for delay-time-programing.
3. DW 0xXX / 0x00 Output number / empty Byte.
4. DW 0XXXXX Delay-time in 100us steps.

As an answer the following data can be found in the recieve compartment:

1. DW 0x04 / 0x00 Length of recieve-data / sourcenumbr must always be 0.
2. DW 0x3A/ 0x05 Acknowledgeing sign ":" / number 7 for programing delay-times.3.
 DW 'O','K' "OK" = done or "ER" = error.

15.8. RK512 Commands

The RK512 command is a special feature for the programming of a CamCon's parameter and **does not** obey the data-protocoll described in chapter "14. CamCon data transfer generell".

15.8.1. RK512 Reading a command

Necessary data in the PLC's send compartement for the reading of an RK512 data record:

1. DW 0x0A / 0x00 Length of send-data / targetnumber must always be 0.
2. DW 0x00 / 0x00 Identification for RK512 Telegramm.
3. DW 0x45 / 0x44 Identification type of job "ED" (E = read / D = data).
4. DW 0xYY / 0xZZ YY = DB Nr. / ZZ = Offset in the DB.
5. DW 0xYY / 0xYY YY = number of datawords (currently from 2 to a maximum of 22).
6. DW 0xFF / 0xFF Coordinating flag always 0xFFFF.

As an answer the following data can be found in the recieve compartement:

1. DW 0xXX / 0x00 XX = Length of recieve-data / sourcenummer must always be 0.
 2. DW 0x00 / 0x00 Identification for RK512 Telegramm.
 3. DW 0x00 / 0xYY always 0 / YY = error message if not 0.
 4. DW 0XXXXX XXXX = 1. half data double-word.
 5. DW 0YYYYY YYYY = 2. half data double-word.
- " Recieve-length corresponding to the number of datawords (11 double data-words = 22 datawords).

15.8.2. RK512 Writing commands

Necessary data in the send compartement of the PLC for the programming of an RK512 data record:

1. DW 0xXX / 0x00 XX = Length of the send-data / targetnumber has to be 0.
2. DW 0x00 / 0x00 Identification of a RK512 telegram.
3. DW 0x41 / 0x44 Identification kind of job "AD" (A = writing / D = data).
4. DW 0xYY / 0xZZ YY = DB Nr. / ZZ = Offset at the DB.
5. DW 0xYY / 0xYY YY = number of datawords (currently from 2 to a maximum of 22).
6. DW 0xFF / 0xFF Coordinating flag always 0xFFFF.
7. DW 0XXXXX XXXX = 1. half data double-word.
8. DW 0YYYYY YYYY = 2. half data double-word.

" Send length corresponding to the number of datawords (11 double data-words = 22 datawords).

As an answer the following data can be found in the recieve compartement:

1. DW 0x04 / 0x00 XX = Length of recieve-data / sourcenummer must always be 0.
2. DW 0x00 / 0x00 Identification of a RK512 telegram.
3. DW 0x00 / 0xYY always 0 / YY = error message (0 = OK).

15.8.3. List of possible RK512 commands

The complete description of all data records can be found on the internet at <http://www.digitronic.com/ftp/rk512.pdf>. The function of specific parameter can be looked after in the corresponding chapters of the CamCon's manual.

DB Nummer 203	DD0	measuring system
	0	= 256 Impulse SSI Singelturn.
	1	= 360 Impulse SSI Singelturn.
	2	= 512 Impulse SSI Singelturn.
	3	= 1000 Impulse SSI Singelturn.
	4	= 1024 Impulse SSI Singelturn.
	5	= 2048 Impulse SSI Singelturn.
	6	= 4096 Impulse SSI Singelturn.
	7	= 8192 Impulse SSI Singelturn.
	0xfffffff	= Special measuring system
DB Nummer 203	DD1	= 0 = Special measuring system SSI.
DB Nummer 203	DD2	= Resolution in Bit at Special measuring system SSI.
DB Nummer 203	DD3	= Offset in Bit at Special measuring system SSI.
DB Nummer 203	DD4	= Clipping at Special measuring system SSI.
DB Nummer 203	DD5	= SSI - Errorbit at Special measuring system SSI.
DB Nummer 203	DD1	= 1 = Special measuring system parallel.
DB Nummer 203	DD2	= Resolution at Special measuring system Parallel.
DB Nummer 203	DD3	= from inputnumber. at Special measuring system Parallel.
DB Nummer 203	DD4	= 0=Gray / 1=Binär at Special measuring system Parallel.
DB Nummer 203	DD1	= 2 = Special measuring system incremental.
DB Nummer 203	DD2	= Resolution at Special measuring system Ink.
DB Nummer 203	DD3	= Pre-divisor at Special measuring system Ink.
DB Nummer 203	DD4	= Clearmode at Special measuring system Ink.
DB Nummer 203	DD1	= 3 = Special measuring system Multi.
DB Nummer 203	DD2	= Resolution at Special measuring system Multi.
DB Nummer 203	DD3	= Turn at Special measuring system Multi.
DB Nummer 203	DD4	= Divisor at Special measuring system Multi.
DB Nummer 203	DD1	= 4 = Special measuring system PLL.
DB Nummer 203	DD2	= Impulse per Initiator at Special measuring system PLL
DB Nummer 203	DD3	= Number of Initiators at Special measuring system PLL
DB Nummer 203	DD4	= Synchrone window at Special measuring system PLL
DB Nummer 203	DD5	= Initiator - input at Special measuring system PLL
DB Nummer 203	DD6	= Clear - input at Special measuring system PLL
DB Nummer 203	DD7	= Synchrone output at Special measuring system PLL
DB Nummer 203	DD1	= 5 = Special measuring system Timer.
DB Nummer 203	DD2	= Resolution at Special measuring system TIMER
DB Nummer 203	DD3	= time per step in ms at Special measuring system TIMER
DB Nummer 203	DD4	= Halt - input at Special measuring system TIMER
DB Nummer 203	DD5	= Clear - input at Special measuring system TIMER
DB Nummer 203	DD8	Actual value - hysteresis
DB Nummer 203	DD9	Controll of the special measuring system.
DB Nummer 203	DD10	Gear multiplier.
DB Nummer 203	DD11	Gear divisor.
DB Nummer 203	DD12	Measuring system type (0=rot; 1=lin).
DB Nummer 203	DD13	Starting value for lin. measuring system.

DB Nummer 203	DD14	Offset = zero-point shift.
DB Nummer 203	DD15	Preset - value
DB Nummer 203	DD16	Preset - input number.
DB Nummer 203	DD17	Preset - Type (RAM/EEProm).
DB Nummer 203	DD18	Speed factor.
DB Nummer 203	DD19	100%-speed value.
DB Nummer 203	DD20	Speed accuracy
DB Nummer 203	DD21	Display switch-mode (0=auto;1=spped;2=pos).
DB Nummer 203	DD22	Input for display switching.
DB Nummer 203	DD23	Cable length
DB Nummer 203	DD24	Cycle time in μ s.
DB Nummer 203	DD25	Safety output.
DB Nummer 203	DD26	Actual value output (0=aus;1=Gray;...).
DB Nummer 203	DD27	Rotation-direction output.
DB Nummer 203	DD28	Standstill-output.
DB Nummer 203	DD29	Speed hysteresis.
DB Nummer 203	DD30	Number of camswitch-input.
DB Nummer 203	DD31	Number of camswitch-output.
DB Nummer 203	DD32	Number of speed compensated outputs.
DB Nummer 203	DD33	Input for keyboard-lock.
DB Nummer 203	DD34	Number of inputs for external program selection.
DB Nummer 203	DD35	Number for external program selection.
DB Nummer 203	DD36	Program selection mode
DB Nummer 203	DD37	Actual value for program selection mode 2.
DB Nummer 203	DD53	Master - Program function ON = 1 OFF = 0.
DB Nummer 203	DD54	Master - Program Number (0 to 32767).
DB Nummer 203	DD55	Master - Programm outputs 1-32.
DB Nummer 203	DD56	Master - Programm outputs 33-64.

16. Technical data of the CamCon

Display	24 * Status LED per output, 4 * status LED for power supply, 1 * status LED for error messages and 1 * status LED for DC300 internal peripheral equipment.
Interfaces	RS485 and S7 300 BUS.
No. of outputs.....	24, electrically isolated from S7 of these, Output 17 - 24 are connected with Input 1 - 8 (optionally expandable to 200 through external interface).
No. of inputs.....	8, electrically isolated from S7 of these, Input 1 - 8 are connected with Output 17 - 24 (optionally expandable to 200 through external interface).
No. of programmable cams	600 or optional 3700 cams.
Data security / Storage.....	EEPROM
No. of programs	32768
Cycle time, (switching speed)	from 0.1 ms, adjusted as required (optimized).
Delay time compensation (DTC).....	individually adjustable for each output, depending on the measuring system and storage location.
Setting range of the DTC	0 to max. 9999.9ms, depending on the measuring system and storage location.
Accuracy of the DTC.....	+0 to -1 step
Measuring system input	synchronous serial (SSI), gray coded, optional incremental data input, PLL data input, time-controlled data input.
Resolution of the measuring system	360 steps (Standard), otherwise adjustable depending on the measuring system and storage location.
Measuring systems (SSI).....	AAG60007, AAG612-2048, AAG612-4096, AAG612-8192, AAG615, AAG626 or AAG66107.
Measuring systems (incremental)	ADG60/24/500.
Limiting frequency of the incremental input	approx. 100kHz
Input level of the incremental input	24V PNP.
Zero offset compensation of the measuring system will be programmed in the CamCon.	
Direction of rotation of the measuring system will be programmed in the CamCon.	
Length of connection cable between the measuring system and CamCon	for SSI, up to a max. 300m (optional up to 1000m)
Distribution voltage.....	24V DC \pm 20 %
measuring system - distribution voltage.....	with 24V DC through the distribution voltage of the peripheral equipment (terminal 30).
current consumption from S7 BUS	typically 450mA
current consumption peripheral equipment	typically 100mA w/o measuring system and outputs
Output voltage.....	24V DC, positive switching
Fan-out current	0,5A per output, short circuit-proof
Programming	through PC w/ software DIGISOFT for CamCon DC16/40/50/90/115/300 or CamCon DC50/51 and CT10 Terminal as well as through the S7 BUS.
Storage requirement for S7 components.....	working storage ca. 10kB, loading storage ca 13 kB.
Connections for Power supply, RS485 interface, measuring system and cam outputs.....	through plug-in terminal screw, 40-pole, Siemens order no.: 6ES7 392 - 1AM00-0AA0 (not included with the DC300).
Assembly.....	see Chapter "3. Assembly" on page 14.
Work temperature.....	0°C ... + 55° C
Weight.....	approx. 430g with connector plug.

17. Key word table

3964(R)	72
Actual position preset.....	59
Actual position, Output.....	63
Actual value, High-Speed.....	98
Adding cams	39
Adding cams, Example	44
ADR.....	32; 91
AG615 - Single - Multiturn - Measuring system	55
Analog cam, Adding.....	47
Analog cam, Changing.....	47
Analog cam, Configuration.....	64
Analog cam, First creation	47
Analog cams, Programming	46
Analog measuring system input.....	24
Analog outputs	75
Analog outputs, adjusting.....	75
Analog outputs, Clearing integrated.....	75
Analog outputs, External.....	75
Analog, Position output	66
Analog, Speed output.....	64
Assembly.....	15
BASADR	94
brake functions.....	13
Cable length	62
Cam data	95
Cam deletion.....	40
Cam input.....	38
Cam programming	35
Cam search.....	39
Cam track, Deletion	40
Cam-BUS.....	72
Cams table.....	96
CE	2
centre pressure	13
Clampinc allocation,serial RS232 interface	21
Clear.....	85
Communication mode.....	72
Communication, S7 <-> DC300.....	89
Complete deletion	71
Configure Hardware	78
configure user.	77
Connections, electrical.....	17
Controll.....	49
Controlling the measuring system.....	49
Copying cam tracks	41
Copying programmed outputs.....	41
Copying programs.....	42
CP Inputs/Outputs.....	78
CP16 Module	78
Cycle time	62
DATE_DB	91
DB40, Process alert.....	76
DBxx	95
Delay time compensation, Effects.....	10

Delay time data	95
delay time for Speed Compensation, separate for switch-ON and switch-OFF points.....	14
Delay time table	96
Delay time, Calculation	12
Deleting programs.....	42
Deletion of a particular cam, Example	45
Device info	79
Direction output.....	63
Dis.input. with analog cams	65
Dis.value with analog cams	65
Display format, Actual position.....	50
Display, Change.....	33
Display, Standard.....	33
Display, Type	61
DP adresse	78
EEPROM cam storage, Calculation.....	87
EEProm storage is full	84
EEPROM, Error	84
ENABLE	91
Enable, outputs	66
Encoder-controll.....	49
Error - aknowledging, input.....	66
Error messages.....	82
ET200M	32
Examples for cam programming.....	43
Export.....	95
External Interface.....	21
External program selection, Setting.....	67
FB51.....	90
FB51 Parameter.....	91
FC51 Parameter	94
FC51, I/O Copy program.....	94
Gear, Electronic	50
Hardware catalogue.....	32
High - Speed I/O	94
HIPER - measuring system.....	56
Hiperface.....	24
Hysteresis	63
Hysteresis, Actual position.....	48
IM153	32
IN_BEFEHLE	91
incremental	56
Incremental - measuring system, Configuration	52
Incremental measuring system input.....	23
Initial Operation.....	31
Input of text	30
Input wiring.....	26
Inputs, general	26
Inputs, Setting	66
Inputs, Status display.....	33
Installation, S7 Software	89
Instance DB	91
Interbus	78
Interpol. with analog cams	65
Interrupt.....	76; 94

Key functions, Outline	29
Keyboard lock, Setting	66
Keys, Checking	70
Language	77
Linear system, Measuring offset	58
Locking EEPROM memory	76
MachineCams	68
Machineprogram	68
Main menu	33
MasterCams.....	68
Masterprogram.....	68
Measuring offset	58
Measuring system.....	48
Measuring system, General information	22
Measuring system, Selection	48
Menu outline.....	86
Menu point, Selection.....	29
Menu, Selection	29
millenium	2
Mounting instructions	15
Movement direction, Change	50
Multiturn measuring system with electronic gear	53
Multuser.....	72
No contact to unit XX	82
OB1	90
OB100	94
OB40	94
Offset	58
OP - Function.....	78
Options, Additional.....	73
Out - Error	84
OUTPUT	94
Output disconnection	94
Output name, Programming	38
Output release	94
Output selection for programming	35
Output status.....	94
Output, Deletion	40
Outputs with DTC, Setting	66
Outputs, additional.....	78
Outputs, general	26
Outputs, lock.....	66
Outputs, Setting	66
Outputs, Status display	33
Parallel - Gray special measuring system.....	52
Parallel measuring system input.....	22
Parameter data	95; 97
PC software	28
PDF - File.....	2
PLC Logic Module.....	73
PLC Logic Module with text display	74
PLC Logic Module, Examples.....	73
PLL measuring system	54
PLL measuring system input.....	25
Pos - Err 1	82

Pos - Err 2.....	82
Pos - Err 3.....	83
Pos - Err 5.....	83
Power supply of the CamCon	18
Preset.....	59
Process alert.....	76
Process interrupt.....	94
Profibus.....	78
Program change	34
Program name	34
Program number.....	34
Program selection for programming	36
Program selection mode.....	67
Programing way-Cams	37
Programming	35
Programming and reading parameter.....	93
Programming the delay time/speed compensation , Private	36
Programming via remote	73
Programming, General information.....	28
Projecting the S7 CPU	32
RAM, storage requirement, calculation.....	88
RAM-Full	83
Reaction time	94
Reading and programming cams.....	92
Reading and programming delay time.....	92
RELEASE.....	94
Release	91
Required functional blocks.....	89
Restart	91
RK512	97
RK512 data	95
RK512 Prozedur.....	72
RK512 Reading and programming data record.....	93
RK512 Table	97
Roll - Over.....	56
Rotation direction, Change.....	50
RS232 as a measuring system	25
RS232 measuring system.....	55
S5 - L1.....	72
S7 Program.....	89
Security output	62
Ser.mode	72
Serial interface, Configuration.....	72
serial RS232 interface.....	21
Serial RS485 interface	19
Shifting cam tracks	41
SIM - measuring system simulator	56
Special measuring system.....	51
Special measuring system, Deletion.....	57
Special outputs.....	62
Speed adjustment.....	60
speed compensation for on-/off-switchpoint	36
Speed Compensation, Effects	10
Speed display, Accuracy.....	61
Speed display, Display format.....	60
Speed display, Range adjustment	60
Speed factor.....	60
Speed, High-Speed.....	98
SSI - measuring system.....	51

SSI measuring system input	22
Stack Info	81
Standard.....	72
Standstill output.....	63
Status displays	27
STATUS_OUT	91
System upgrading	66
Table of contents	3
Teach - In.....	39
Technical data.....	106
Terminal assignment, inputs.....	17
Terminal assignment, outputs.....	17
Terminal connections, incremental measuring system.....	18
Terminal connections, SSI measuring system.....	18
Terminal connections,serial RS485 interface	19
Terminating resistors, serial RS485 interface.....	20
Text input	30
The status LED	27
Time -Cam	14
Time emitter measuring system simulation	54
Timer as a measuring system.....	25
TIMER_TIMEOUT.....	91
Unit configuration	48; 69; 72
Unit number, Input	73
UP - Date	2
User key, Creation	69
User key, Deletion.....	70
User keys, Allocation.....	69
user menu.....	78
User text.....	77
Version, S7 Software	89
Vmax.....	49
Welding operations, Safety precautions	26
Y2K	2
Zero offset.....	58
Zero offset, External.....	59