

Digital Cam Controller

CamCon DC115

for S5 115U / 135U / 155U



Digitronic Automationsanlagen GmbH

Steinbeisstraße 3 · D - 72636 Frickenhausen · Tel. (+49)7022/40590-0 · Fax -10
Auf der Langwies 1 · D - 65510 Hünstetten-Wallbach · Tel. (+49)6126/9453-0 · Fax -42
Internet: <http://www.digitronic.com> · E-Mail: mail@digitronic.com

For your attention

This instruction manual relates to the CamCon DC115 from Nov. 1997. The company Digitronic Automationsanlagen GmbH reserves the right to make changes which present an improvement of the quality or functionality of the device without prior notice. The instruction manual was created with great care, although it may not be error-proof. We would be grateful for any communication relating to any errors you may have found.

UP-date

You can also access this instruction manual on the Internet at <http://www.digitronic.com> in the latest version as PDF file.

Qualified personnel

This device may only be started and operated by qualified staff. By qualified we mean personnel who are entitled to handle, to earth and to label devices, systems and power circuits in accordance with the technology safety standards.

Liability

(1) The supplier is liable for damages caused by himself or by the owner of the rights up to the sum of the sales price. He is not liable for loss of profits, forfeited savings, intermediate and successive damages.

(2) The above mentioned limits to liability do not apply to insurance of named characteristics and damages which were caused deliberately or through negligence.

Protection

The CamCon DC115 and this instruction manual are protected by copyright. All rights are reserved. Neither the CamCon DC115, nor this document may be copied as a whole, photocopied, reproduced, translated or transferred to electronic media of any kind or into machine readable format without prior written permission by the company Digitronic Automationsanlagen GmbH.

Note: We have examined the devices of the CamCon series for year 2000 compatibility and have not found any adverse effects on any functions.

Note: CamCon is a registered trademark of the company Firma Digitronic Automationsanlagen GmbH.

Note: The devices of the CamCon series comply with the standards for electromagnetic compatibility: EN 55011, EN 55022, EN 55024 Part 2, EN 50082 Part 2, ENV 50140, VDE 0843 Part 2, VDE 0843 Part 4, VDE 0871, VDE 0875 Part 3 ("N"), VDE 0875 Part 11, VDE 0877 Part 2, IEC 801 Part 3, IEC 801 Part 2, IEC 801 Part 4, IEC 801 Part 5.



(c) Copyright 1992 - 2002 / File: DC115_E.DOC

Digitronic Automationsanlagen GmbH
Auf der Langwies 1
D-65510 Hünstetten - Wallbach
Tel. (+49)6126/9453-0 Fax. (+49)6126/9453-42
Internet: <http://www.digitronic.com>
E-Mail: mail@digitronic.com

Table of contents

1. Introduction.....	7
2. Principle of function.....	8
2.1. Dead time compensation	9
2.1.1. Calculating the dead time.....	11
2.1.1.1. Calculating the dead time through relocations that have already occurred.....	11
2.1.1.2. Calculating the dead time through the difference of measured values.....	11
3. Component configuration.....	12
3.1. Setting of the component side.....	12
3.1.1. The DIP switches on the component side.....	13
3.1.1.1. DIP switch S3, Kachel number.....	13
3.1.1.2. DIP switch S1	13
3.1.1.2.1. DIP switch S1, Switch 1	13
3.1.1.2.2. DIP switch S1, Switch 2	13
3.1.1.2.3. DIP switch S1, Switch 3	13
3.1.1.2.4. DIP switch S1, switch 4.....	13
3.1.2. Connection plugs on the component side.....	14
3.1.2.1. Connection plug P4.....	14
3.1.2.2. Connection plug P5.....	14
3.1.2.3. Connection plug P6.....	14
3.1.2.4. Connection plug P7.....	14
3.1.2.5. Connection plug P8.....	14
3.1.2.6. Connection plug P9.....	14
3.2. Adjusting the soldering bridges on the soldering side.....	15
3.2.1. Soldering bridges "SJ1, SJ13" and "SJ14, SJ15"	15
3.2.2. Soldering bridges "SJ10, SJ11, SJ12" and "SJ7, SJ8, SJ9"	16
3.2.3. Soldering bridge "SJ3"	16
3.2.4. Soldering bridges "SJ2, SJ4, SJ5, SJ6"	16
3.2.5. Soldering bridge "SJ16"	16
3.2.6. Soldering bridge "SJ17"	16
4. Mechanical installation instructions.....	17
4.1. Assembly with adapter capsule with the AG115U.....	17
4.1.1. Slots in the AG115U.....	17
4.2. Assembly with AG135U / 155U	17
4.2.1. Slots in the AG135U or AG155U.....	17
5. Electrical connections	18
5.1. Pin allocation of the CamCon DC115	18
5.1.1. Pin allocation of the encoder input with the SSI measuring system.....	18
5.1.2. Pin allocation of the encoder input with the 5 Volt (RS422) incremental measuring system.....	18
5.1.3. Pin allocation of the encoder input with the 24 Volt (PNP) incremental measuring system.....	18
5.1.4. Pin allocation of the encoder input with the 24 Volt PLL measuring system.....	18
5.1.5. Pin allocation of the external interface with 9 poles	19
5.1.6. Pin allocation of the serial interface with 9 poles.....	19
5.1.6.1. Pin allocation of the serial RS232 interface	19
5.1.6.2. Pin allocation of the serial RS485 interface	20
5.1.7. Pin allocation of the analog output.....	21
5.1.8. Pin allocation of the inputs	21
5.1.9. Pin allocation of the outputs	21
5.1.10. Voltage supply of the CamCon.....	22
5.2. The measuring system.....	23
5.2.1. SSI measuring system input	23
5.2.2. Parallel measuring system input	23
5.2.3. Incremental measuring system input	24
5.2.3.1. Incremental measuring system input with 5V RS422 level.....	24
5.2.3.2. Incremental measuring system input with 24V PNP level.....	24
5.2.4. Analog measuring system input.....	25
5.2.5. PLL measuring system input.....	25
5.2.6. Timer as a measuring system.....	25

5.2.7. RS232 as a measuring system	25
5.3. The outputs	26
5.4. The inputs	26
5.5. Safety precautions during welding operations.....	26
5.6. The status LED	27
6. General programming information	27
6.1. Outline of key functions.....	28
6.2. Menu selection	28
6.3. Selection of a menu point.....	28
6.4. Text input	29
7. Commissioning.....	30
8. Operation of the CamCon	32
8.1. The main menu	32
8.2. The standard display	32
8.2.1. Changing the display.....	32
8.2.2. Program change.....	33
8.2.3. Program name	33
8.3. Cam programming	34
8.3.1. Output selection for programming.....	34
8.3.2. Program selection for programming.....	35
8.3.3. Programming the dead time compensation	35
8.3.4. Programming the output name	36
8.3.5. Cam Input.....	36
8.3.6. Adding cams	37
8.3.7. Cam Teach - In	37
8.3.8. Cam Search	37
8.3.9. Cam deletion	38
8.3.10. Output (cam track) deletion.....	38
8.3.11. Copying programmed outputs (cam tracks).....	39
8.3.12. Shifting cam tracks.....	39
8.3.13. Deleting programs.....	40
8.3.14. Copying programs	40
8.3.15. Examples for cam programming.....	41
8.3.15.1. First cam programming	41
8.3.15.2. Programming additional cams on an output	42
8.3.15.3. Deletion of a particular cam	43
8.3.16. Programming analog cams	44
8.3.16.1. Creating the first analog cam	45
8.3.16.2. Adding an analog cam	45
8.3.16.3. Changing the analog cam	45
8.4. Unit configuration (system setting).....	46
8.4.1. Measuring system	46
8.4.1.1. The standard measuring systems.....	46
8.4.1.2. The actual position hysteresis.....	46
8.4.1.3. The electronic gear	47
8.4.1.3.1. Electronically changing the rotation direction.....	47
8.4.1.4. The display format of the actual position.....	47
8.4.1.5. Configuration of a special measuring system	48
8.4.1.5.1. SSI measuring system	48
8.4.1.5.2. Parallel Gray measuring system	49
8.4.1.5.3. Inkremental-measuring system.....	49
8.4.1.5.4. Multiturn measuring system with electronic gear	50
8.4.1.5.5. PLL measuring system.....	51
8.4.1.5.6. Timer way simulation (time emitter).....	51
8.4.1.5.7. RS232 measuring system	52
8.4.1.6. Delting the special measuring system.....	52
8.4.2. The measuring offset	53
8.4.2.1. Zero offset with rotatory movements.....	53
8.4.2.2. Measuring offset with a linear moved system	53

8.4.2.3. Zero offset with linear movements	53
8.4.2.4. Actual position preset.....	54
8.4.3. The speed adjustment.....	55
8.4.3.1. The speed factor	55
8.4.3.2. The display format of the speed display.....	55
8.4.3.3. Range adjustment of the speed display.....	55
8.4.3.4. Accuracy of the speed display.....	56
8.4.3.5. Display, Type.....	56
8.4.4. Cable length / Cycle time	57
8.4.4.1. The cable length.....	57
8.4.4.2. The cycle time of the CamCon.....	57
8.4.5. The special outputs	57
8.4.5.1. The security output.....	57
8.4.5.2. The output of the actual position	58
8.4.5.3. Direction output	58
8.4.5.4. The standstill output	58
8.4.5.5. The hysteresis	58
8.4.5.6. The analog speed output	59
8.4.5.7. Configuration of the analog cams	59
8.4.5.8. The analog position output.....	60
8.4.6. System upgrading	61
8.4.6.1. Setting the inputs.....	61
8.4.6.2. Setting the outputs	61
8.4.6.3. Setting the outputs with dead time compensation.....	61
8.4.6.4. Setting the keyboard lock.....	61
8.4.6.5. Setting the external program selection.....	61
8.4.6.6. Setting the program selection mode	62
8.5. Unit configuration	63
8.5.1. User key allocation	63
8.5.1.1. Creating a new user key.....	63
8.5.1.2. Deletion of a user key.....	64
8.5.1.3. Checking the key configuration.....	64
8.5.2. Complete deletion	65
8.5.3. Unit configuration	66
8.5.3.1. Setting the serial interface.....	66
8.5.3.1.1. The "Cam-BUS" communication mode.....	66
8.5.3.1.2. The "Standard" communication mode	66
8.5.3.1.3. The "Multiuser" communication mode	66
8.5.3.1.4. The "S5 - L1" communication mode	66
8.5.3.1.5. Input of the unit number	67
8.5.3.1.6. Programming via remote.....	67
8.5.3.2. Additional device options.....	67
8.5.3.2.1. PLC Logic Module.....	67
8.5.3.2.1.1. Examples for using the PLC logic module	67
8.5.3.2.2. PLC Logic Module with text display.....	68
8.5.3.3. Analog outputs	69
8.5.3.3.1. Clearing the integrated analog outputs	69
8.5.3.3.2. Adjusting the integrated analog outputs.....	69
8.5.3.3.3. External analog outputs.....	69
8.5.4. Language	70
8.5.5. User text.....	70
9. Device info.....	71
10. Error messages and error recovery	74
10.1. Problem: Display shows "No contact to unit: XX".....	74
10.2. Problem: Display shows "Pos - Err:1"	74
10.3. Problem: Display shows "Pos - Err:2"	74
10.4. Problem: Display shows "Pos - Err:3"	75
10.5. Problem: A "Pos - Err:" occurs during operation.....	75
10.6. Problem: Outputs will not activate.....	75

10.7. Problem: Display shows "Out - Error".	76
10.8. Problem: Display shows an error in the EEPROM.	76
10.9. Problem: Display shows "Error ???"	76
10.10. Problem: Display shows "Clear...."	76
11. Menu outline	77
12. Calculation of the EEPROM cam memory	78
13. Calculation of the RAM memory of the CamCon	79
14. Kachel communication between S5 and CamCon DC115	80
14.1. Kachel allocation	80
14.1.1. Kachel range independent of task	80
14.1.2. Kachel range dependent on task	81
14.2. Tasks	82
14.2.1. 00h-01h: task => "Start CamCon DC115"	82
14.2.1.1. 00h-01h: protocol => "Start CamCon DC115"	82
14.2.2. 00h-02h: task => "Program-Parameter and Start CamCon DC115"	82
14.2.2.1. 00h-02h: protocol => "Program-Parameter and Start CamCon DC115"	83
14.2.3. 00h-03h: task => "Read-Parameter"	84
14.2.3.1. 00h-03h: protocol => "Read-Parameter"	84
14.2.4. 00h-04h: task => "Cam program deletion"	86
14.2.4.1. 00h-04h: protocol => "Cam program deletion"	86
14.2.5. 00h-05h: task => "Test on cam program exists"	86
14.2.5.1. 00h-05h: protocol => "Test on cam program exists"	86
14.2.6. 00h-06h: task => "Program cam program"	87
14.2.6.1. 00h-06h: protocol => "Program cam program"	87
14.2.7. 00h-07h: task => "Read cam program"	88
14.2.7.1. 00h-07h: protocol => "Read cam program"	88
14.2.8. 00h-0Bh: task => "Reset error message"	89
14.2.8.1. 00h-0Bh: protocol => "Reset error message"	89
14.2.9. 00h-0Ch: task => "Program dead times"	90
14.2.9.1. 00h-0Ch: protocol => "Program dead times"	90
14.2.10. 00h-0Dh: task => "Read dead times"	90
14.2.10.1. 00h-0Dh: protocol => "Read dead times"	90
14.2.11. 00h-0Eh: task => "Program PLC Logic Module output"	91
14.2.11.1. 00h-0Eh: protocol => "Program PLC Logic Module output"	91
14.2.12. 00h-0Fh: task => "Read PLC Logic Module output"	92
14.2.12.1. 00h-0Fh: protocol => "Read PLC Logic Module output"	92
14.2.13. 00h-10h: task => "Complete deletion of the CamCon DC115"	92
14.2.13.1. 00h-10h: protocol => "Delete CamCon"	92
14.3. Priority tasks	93
14.3.1. 01h-01h: Priority task => "CamCon status read"	93
14.3.1.1. 01h-01h: Priority protocol => "CamCon status read"	93
14.3.2. 01h-02h: Priority task => "Shifting the zero point"	94
14.3.2.1. 01h-02h: Priority protocol => "Shifting the zero point"	94
14.3.3. 01h-03h: Priority task => "Program selection"	95
14.3.3.1. 01h-03h: Priority protocol => "Program selection"	95
14.3.4. 01h-04h: Priority task => "Transfer CamCon controlling inputs"	95
14.3.4.1. 01h-04h: Priority protocol => "Transfer CamCon controlling inputs"	96
14.4. Error numbers in the protocol bytes (00h and 01h) of the CamCon DC115	96
14.5. Example for Kachel communication between S5 and CamCon DC115	97
15. Technical Data	101
16. Keyword table	102

1. Introduction

Electrical cam switch units have been used successfully by the industry for a long time. The experiences which have been collected in close co-operation during these years have been considered during the development of the CamCon. The result is a compact digital cam switch unit which owns a maximum of user friendliness and reliability.

The following characteristics distinguish the CamCon:

- * Experienced and reliable hardware
- * Short circuit-proof outputs
- * Graphical liquid crystal display with 128x64 picture elements on CamCon DC50/51
- * As many cams per output as programmable
- * Optimizing of the switching points while the machine operates
- * In steps of 100µs adjustable compensation of the mechanical dead time of switch units
- * Voltage supply 24V DC +/- 20%
- * Carrier rail assembly according to EN 50022 on CamCon DC16 and DC90.
- * Switchboard norm encasement 144 x 144 x 63mm according to DIN 43700 on CamCons DC40,50 and 51.
- * S5 operation group for Simatic® S5 115U, 135U and 155U on CamCon DC115.
- * S5 connection via PG interface with L1 - BUS.
- * S7 operation group for Simatic® S7 300 on CamCon DC300.
- * PLC logic module (optional)
- * Analog outputs (optional)

Note: Simatic® is a registered trademark of the Siemens company.

Cam switch units are being used everywhere where switching procedures are being periodically repeated. Digital cam switch units replace mechanical ones optimally and furthermore offer other advantages, for example:

- * Simplification of assembly and adjustment procedures
- * Reproducible adjustments
- * Standardisation for all possible ranges of operation
- * Reliability
- * High switching speed
- * Dead time compensation

2. Principle of function

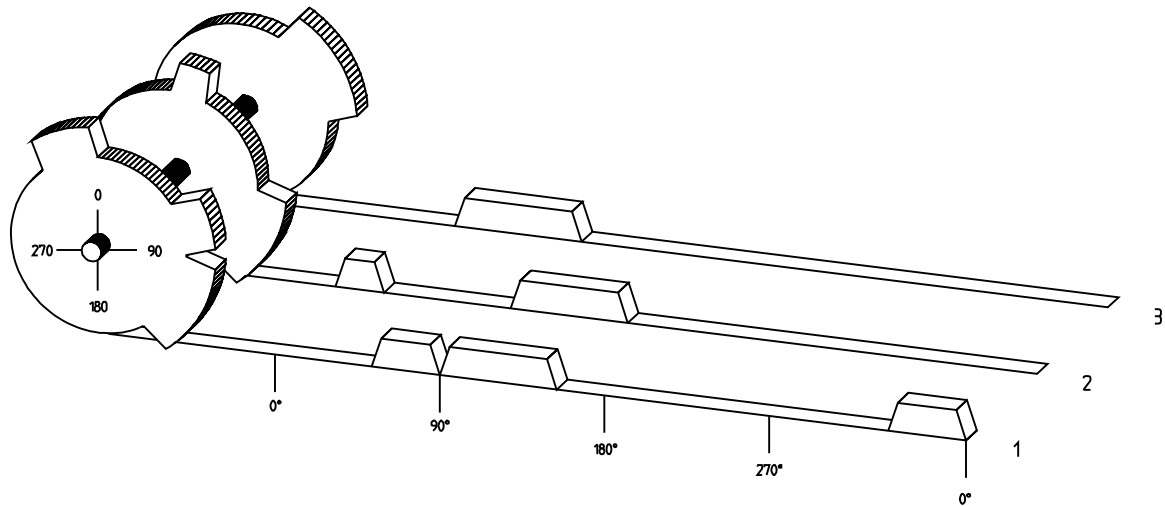

Fig.: Presentation of the principle of a cam switch unit

For a better understanding of the function of a cam switch unit, its principle is presented here. It has 3 outputs containing the following cams:

Output 1:	Cam 1:	Activation point	60°	Deactivation point	85°
	Cam 2:	Activation point	95°	Deactivation point	145°
	Cam 3:	Activation point	325°	Deactivation point	355°
Output 2:	Cam 1:	Activation point	5°	Deactivation point	20°
	Cam 2:	Activation point	95°	Deactivation point	145°
Output 3:	Cam 1:	Activation point	30°	Deactivation point	85°

The 3 as beds presented progressions of the output signals occur, if the 3 cam plates turn anticlockwise past a sensor, which scans the cams on the 0° axis.

The duration of the activation of a mechanical cam switch unit, i.e. the range between the on and off position, is determined by the length of the cams. The length and the position of the cams can only be limitedly varied, which additionally demands a relatively high mechanical and chronological expenditure. With the CamCon, these adjustments are realisable in a fraction of a second, besides the number of the cams per bed is optional. A measuring system, which has been connected to the device reports the position to the CamCon. The CamCon compares this with the programmed on and off positions from all the outputs. If a position appears in a range of a programmed on / off position (cams), all affected outputs will be switched.

A small numerical example shall serve the illustration:

Assuming that the drive roll with the measuring system has a circumference of 360mm, so that one millimeter at the circumference corresponds exactly to one angle degree of the measuring system. The unit has the following parameter:

$$\begin{aligned}v_{\text{drop}} &= 20\text{m/s} \\d &= 20\text{cm} \\T_{\text{MV}} &= 20\text{ms}\end{aligned}$$

Out of this results a flight time of the drop to

$$t_{\text{Flight}} = \frac{d}{v_T} = \frac{0,2\text{m}}{20\text{m/s}} = 10\text{ms}$$

So the complete dead time amounts to $T_{\text{dead, altogether}} = T_{\text{MV}} + t_{\text{Flight}} = 20\text{ms} + 10\text{ms} = 30\text{ms}$

During this time the paper web travels by the distance $x = v_{\text{paper}} \cdot T_{\text{dead, altogether}} = 1\text{m/s} \cdot 30\text{ms} = 30\text{mm}$ further on.

The switching point of the magnetic valve has to be transferred 30° to the front to compensate this dead time.

If one doubles the speed of the system and with that v_{paper} , the distance x , by which the paper web is moving on, is also doubled. In this case the switching point has to be transferred by 60° .

Tip: Note that in this explanation the dead time is a solid quantity, which is determined by the mechanical regulation and switching parts as well as by the measurement of the construction, hence it does not change.

If one were now to program the complete dead time of 30ms on the appropriate output of the CamCon, the drop of glue would always hit the exact spot at any speed.

2.1.1. Calculating the dead time

There are several possibilities for calculating the dead time of a relay or a valve.

2.1.1.1. Calculating the dead time through relocations that have already occurred

Program the switching point of the relay or valve during a standstill of the machine. We use the switching point of 200 degrees in our example. If the machine is now run with a speed of e.g. 40 min^{-1} , a relocation occurs because of the dead time. This relocation is measured and is 40 degrees in our example.

Attention: To calculate the relocation correctly you have to set the programmed dead time of the cam switch unit to zero.

The dead time of the switching member is calculated according to the following formula:

$$\text{Dead time (in sec.)} = \frac{\Delta \text{ way (in degrees)} * 60 \text{ (sec./min.)}}{\text{speed (in min}^{-1}\text{)} * 360 \text{ (degrees/rotations)}}$$

$$\text{Dead time (in sec.)} = \frac{40 * 60}{40 * 360} = 0.1667 \text{ sec.}$$

The calculated dead time is now set in the CamCon.

2.1.1.2. Calculating the dead time through the difference of measured values

The switching point is determined at a speed of e.g. 50 min^{-1} . In our example, the programmed switching point is at 200 degrees. The second measurement occurs at a speed of 80 min^{-1} . The needed switching point has to be set to 160 degrees to reach the exact switch point again at 80 min^{-1} .

Attention: To determine the two switching points you have to set the programmed dead time of the cam switch unit to zero.

The dead time of the switching member is calculated with the following formula:

$$\text{Dead time (in sec.)} = \frac{\Delta \text{ way (in degrees)} * 60 \text{ (sec./min.)}}{\Delta \text{ speed (in min}^{-1}\text{)} * 360 \text{ (degrees/rotations)}}$$

$$\text{Dead time (in sec.)} = \frac{40 * 60}{30 * 360} = 0.222 \text{ sec.}$$

The determined dead time is now entered into the cam mechanism. Since this dead time is set for the whole range of the speed, it now becomes necessary to adjust the cam to the speed at 0 min^{-1} . To determine the exact activation point you have to enter the difference to the speed 0 min^{-1} at the first measured activation point. The difference is calculated according to the following formula:

$$\Delta \text{ way (in degrees)} = \frac{\text{dead time (in sec.)} * \Delta \text{ time (in min}^{-1}\text{)} * 360 \text{ (degrees/rotations)}}{60 \text{ (sec./min.)}}$$

$$\Delta \text{ way (in degrees)} = \frac{0.222 * 50 * 360}{60} = 66.6 \text{ degrees}$$

The activation point of the cam is now relocated by 67 degrees, from 200 degrees to 267 degrees.

3. Component configuration

3.1. Setting of the component side

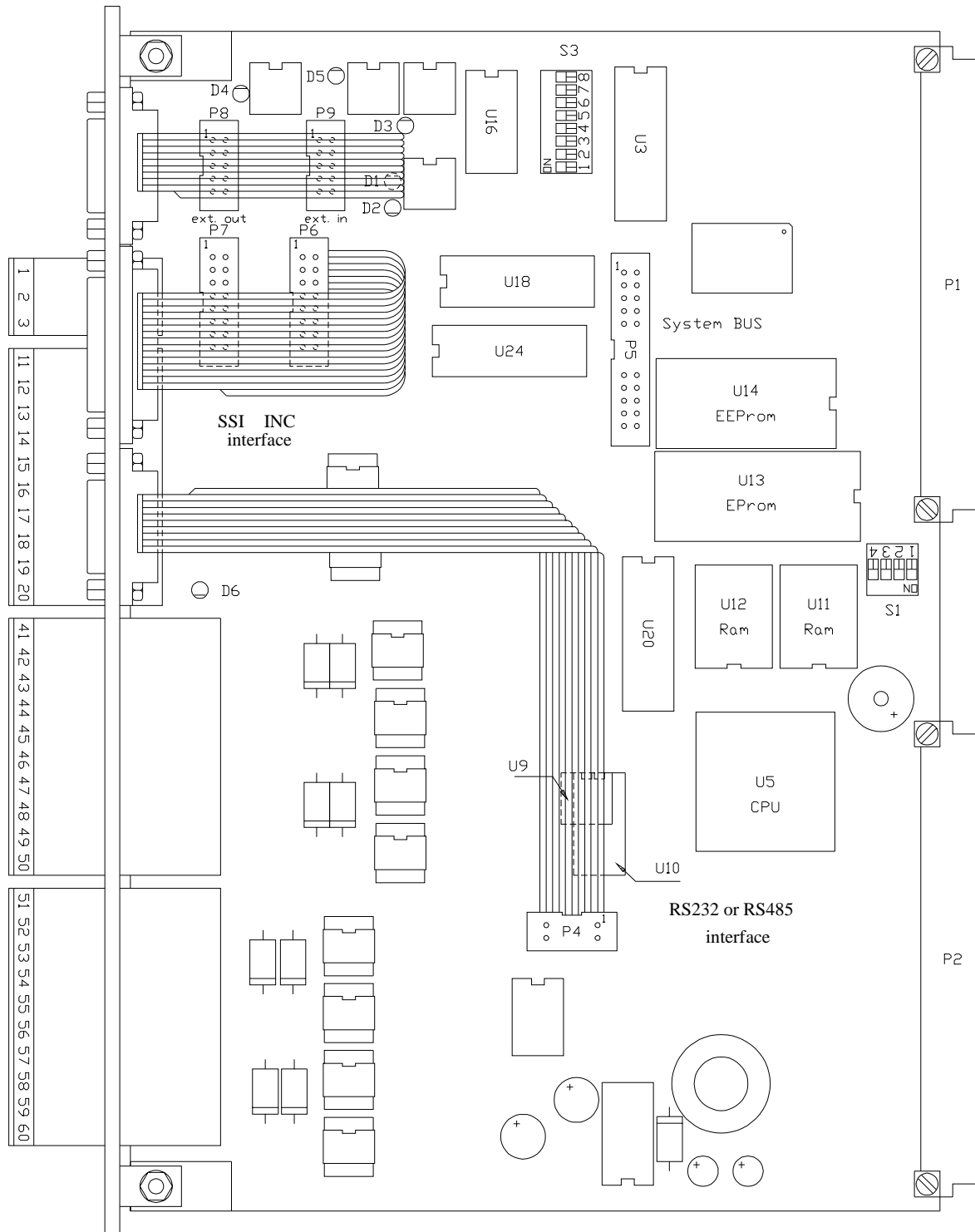

- | | | | |
|--------|---|-----------------|-------------------------|
| IC U9 | = | 75176 | with an RS485 interface |
| IC U10 | = | MAX232 / ADM232 | with an RS232 interface |
| LED D6 | = | Status LED | |

3.1.1. The DIP switches on the component side

3.1.1.1. DIP switch S3, Kachel number

The DIP switch S3 is used to set the Kachel number (or adress) of the S5. Up to 64 Kachel numbers can be set binary (0 to 63). The CamCon DC115 component takes on the Kachel number after a deactivation and a following activation.

Attention: The set Kachel number may not be occupied by another component of the S5.

Example: Kachel number 0 Kachel number 5 Kachel number 10

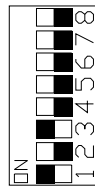

3.1.1.2. DIP switch S1

3.1.1.2.1. DIP switch S1, Switch 1

Switch 1 of the DIP switch S1 controls the Master - Slave - Setting. To run the device on 'Master', the switch has to be set to "ON" (standard). Set the switch to "OFF" for the slave mode. This function is necessary for passing on the actual value during multi-axle operations. The Master recognizes the actual value with its measuring system and passes it on to the Slave via the external interface. If only one single CamCon DC115 is used, the DIP switch must always be set to "ON".

3.1.1.2.2. DIP switch S1, Switch 2

Setting this switch to "OFF" blocks the the access of the S5 BUS on the Kachel. This switch must always be set to "ON" for communication with the S5.

3.1.1.2.3. DIP switch S1, Switch 3

If switch 3 is set to "ON", the CamCon DC115 assembly is stopped via a hardware reset in the Stop mode of the S5. As a standard the assembly generates its reset itself. CamCon DC115 comes with the DIP switch set to "OFF".

3.1.1.2.4. DIP switch S1, switch 4

If switch 4 is set to "ON", the hardware reset of the S5 also functions as a hardware reset of the CamCon DC115 assembly. As a standard the assembly generates its reset itself. CamCon DC115 comes with the DIP switch set to "OFF".

Attention: Since the Kachel address has to be initialized by the CamCon DC115, the access of the S5 to the Kachel has to be delayed, because there would otherwise be an acknowledgement delay.

3.1.2. Connection plugs on the component side

The SUB-D connection plugs facing the front of the CamCon DC115 component can be, according to version and usage, plugged on different pin boards of the component side.

3.1.2.1. Connection plug P4

The plug P4 is used for the connection of the serial interface. According to the type of serial interface (RS485 or RS232), you use the IC U9 (RS485) or the U10 (RS232).

3.1.2.2. Connection plug P5

The plug P5 is for system upgrading and may not be allocated by the user.

3.1.2.3. Connection plug P6

The plug P6 is used as the input of the incremental or the PLL measuring system (SUBD 15).

3.1.2.4. Connection plug P7

The plug P7 is the input of the SSI measuring system (SUBD 15).

3.1.2.5. Connection plug P8

The plug P8 is connected to the output of the external interface.

3.1.2.6. Connection plug P9

The plug P9 is connected to the input of the external interface.

3.2. Adjusting the soldering bridges on the soldering side

On the soldering side of the DC115 assembly are several soldering bridges that are described as follows.

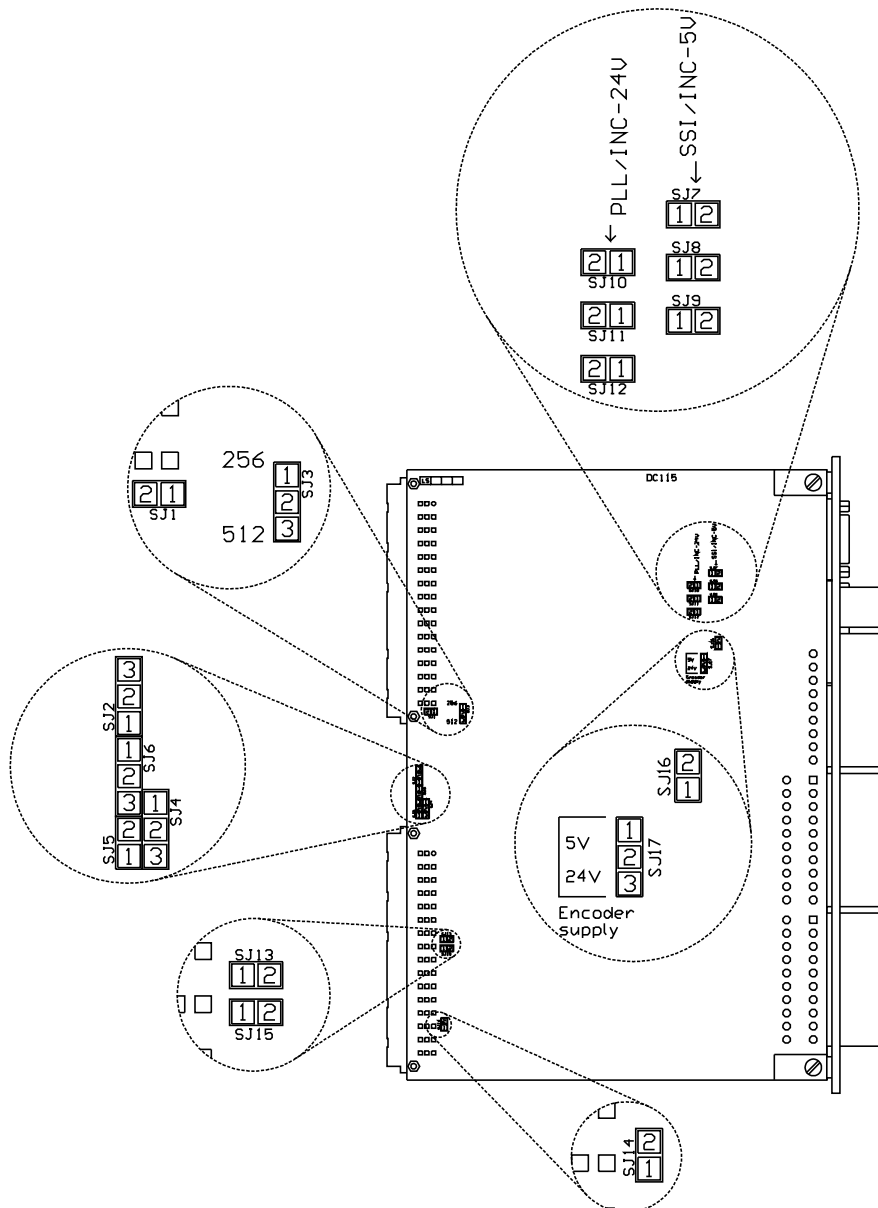

3.2.1. Soldering bridges "SJ1, SJ13" and "SJ14, SJ15"

For the supply of the CamCon DC115' s analog output you need a voltage of 24V. This voltage is available from the BUS of the S5 on the plug board P1 or P2. Please refer to your handbook of the S5, to know which board holds the 24Volt available.

If the soldering bridges SJ1 and SJ13 are closed, the 24Volt are taken from the board P1.

If the soldering bridges SJ14 and SJ15 are closed, the 24Volt are taken from the board P2.

Attention: You may only close bridges SJ1 and SJ13 or bridges SJ14 and SJ15 at the same time, otherwise it would result in a short circuit of the 24V and a destruction of the S5 BUS system.

Tip: The device comes from the company with bridges SJ1 and SJ13 closed (the voltage is taken from board P1).

3.2.2. Soldering bridges "SJ10, SJ11, SJ12" and "SJ7, SJ8, SJ9"

Either soldering bridges SJ10,11,12 or SJ7,8,9 have to be closed, depending on the measuring system you wish to use.

The bridges SJ10, SJ11 and SJ12 have to be closed, if you want to use an incremental measuring system with a signal level of 24Volt or if you chose the PLL measuring system.

The bridges SJ7, SJ8 and SJ9 have to be closed, in case you want to use an SSI measuring system or if you have connected an incremental measuring system with a signal level of 5Volt (RS422)

See also chapter 3.1.2. Connection plugs on the component side on page 14.

Attention: The bridges SJ10, SJ11 and SJ12 must be in the same state (all open or all closed), and the same holds true for bridges SJ7, SJ8 and SJ9. Simultaneously bridging SJ10,11,12 and SJ7,8,9 is not recommendable, as it would result in the destruction of the measuring system input

3.2.3. Soldering bridge "SJ3"

This soldering bridge is used to set the size of the used EProms (U13).

EPROM	SJ 3
IC 27C020 (256kByte)	1 - 2
IC 27C040 (512kByte)	2 - 3

Attention: You may not simultaneously bridge 1 - 2 - 3.

3.2.4. Soldering bridges "SJ2, SJ4, SJ5, SJ6"

These soldering bridges serve to adjust the size of the used RAM memory (U11 and U12).

RAM	SJ 2	SJ 4	SJ 5	SJ 6
1 x 32 kByte	2 - 3	open	1 - 2	open
2 x 32 kByte	1 - 2	open	1 - 2	1 - 2
1 x 128 kByte	2 - 3	open	1 - 2	open
2 x 128 kByte (standard)	1 - 2	open	1 - 2	2 - 3
1 x 512 kByte	2 - 3	1 - 2	open	open
2 x 512 kByte	1 - 2	2 - 3	open	2 - 3

3.2.5. Soldering bridge "SJ16"

This soldering bridge must always be closed. This soldering bridge is not available on hardware revision b.

3.2.6. Soldering bridge "SJ17"

This soldering bridge is used to set the voltage supply for incremental measuring system to 5V or 24V DC.

encoder supply	SJ 17
5V (max. 300mA may be extracted)	1 - 2
24V (max. 500mA may be extracted)	2 - 3

Attention: You may not simultaneously bridge 1 - 2 - 3. This will destroy the device.

Attention: This soldering bridge is not available on hardware revision b. The voltage supply is always 5V DC.

4. Mechanical installation instructions

After having configured the component (see chapter "3. Component configuration" on page 12) you can insert it into the component carrier. To install the CamCon DC115 unit you need an adapter capsule of the type 6ES5 491-0LB11 for Double - European - Format for the AG155U. You do not need the capsule for the AG135U and 155U

4.1. Assembly with adapter capsule with the AG115U

For the assembly, enter the CamCon DC115 component along the rails into the capsule. Afterwards lock the component with the Exzenter at the upper end of the capsule. The capsule with the component is inserted into the component carrier (in a cold state) and is then locked with screws

4.1.1. Slots in the AG115U

With the CamCon DC115, you can allocate the following black marked slots

PS	CPU	0	1	2	3	IM	
-		-	-	-	-	-	central component
-	-		-	-	-	-	DC115 in the CR 700-0

PS	CPU	0	1	2	3	4	5	6	IM	
-		-	-	-	-	-	-	-	-	central component
-	-		-	-	-	-	-	-	-	DC115 in CR 700-1
-	-							-	-	DC115 in CR 700-2
-	-							-	-	DC115 in CR 700-3

4.2. Assembly with AG135U / 155U

For the assembly you insert the CamCon DC115 component in a cold state along the rails into the component carrier. You then lock the component with the locking rail of the component carrier

4.2.1. Slots in the AG135U or AG155U

With the CamCon DC115 you can allocate the following black marked slots.

3	11	19	27	36	43	51	59	67	75	83	91	107	115	123	131	139	146	155	163		
																					central component

5. Electrical connections

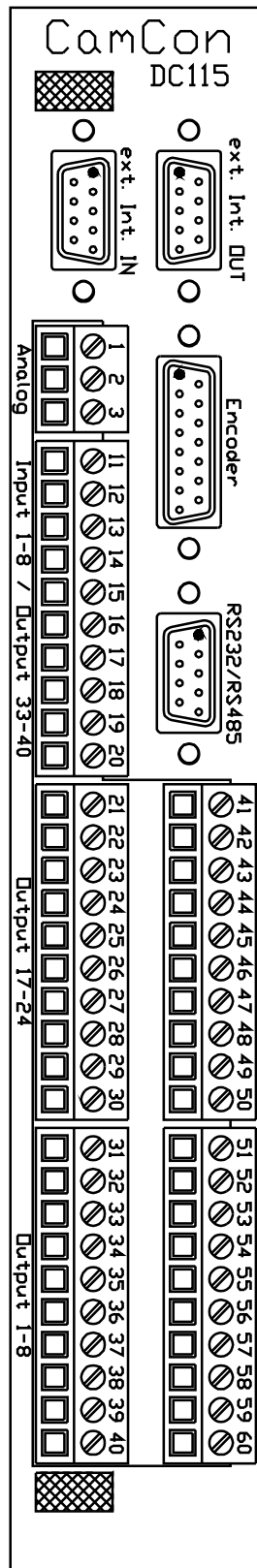

Fig.: CamCon 115

5.1. Pin allocation of the CamCon DC115

5.1.1. Pin allocation of the encoder input with the SSI measuring system

Pin	4,5:	0V for SSI measuring system (encoder)
Pin	12,13:	+24V for SSI measuring system (encoder)
Pin	1:	Data A or (+)
Pin	9:	Data B or (-)
Pin	2:	Clock A or (+)
Pin	10:	Clock B or (-)
Pin	3,6,7,8,11,14,15:	must not be allocated.
Case	:	shielding

5.1.2. Pin allocation of the encoder input with the 5 Volt (RS422) incremental measuring system

Pin	4,5:	0V for incremental measuring system (encoder)
Pin	12,13:	Voltage supply for incremental measuring system (encoder) (see chapter "3.2.6. Soldering bridge "SJ17" on page 16).
Pin	1:	A impulse (+)
Pin	9:	A impulse (-)
Pin	2:	B impulse (+)
Pin	10:	B impulse (-)
Pin	3:	C1 impulse (+)
Pin	11:	C1 impulse (-)
Pin	6:	C2 impulse 24V signal
Pin	14,15:	signal mass for C2 impulse
Pin	7,8:	must not be allocated.
Case	:	shielding

5.1.3. Pin allocation of the encoder input with the 24 Volt (PNP) incremental measuring system

Pin	4,5:	0V for incremental measuring system (encoder)
Pin	12,13:	Voltage supply for incremental measuring system (encoder) (see chapter "3.2.6. Soldering bridge "SJ17" on page 16).
Pin	1:	A impulse
Pin	2:	B impulse
Pin	3:	C1 impulse
Pin	6:	C2 impulse
Pin	9,10,11,14,15:	signal mass
Pin	7,8:	must not be allocated.
Case	:	shielding

5.1.4. Pin allocation of the encoder input with the 24 Volt PLL measuring system

Pin	1:	Tact impulse
Pin	2:	synchronous impulse
Pin	9,10,11,14,15:	signal mass
Pin	2 to 8 u.12,13:	must not be allocated.
Case	:	shielding

5.1.5. Pin allocation of the external interface with 9 poles

To connect additional outputs and inputs or to operate the CamCon in the Master - Slave - Mode you have to use the external interface. The cable connecting the interfaces has 6 poles (max. 1000m cable length). The data transfer is done by opto couplers, leaving the connection free of potentials.

DSUB 9 socket: output of the external interface (Master)
DSUB 9 pin board: input of the external interface (Slave)

Pin	1,4,7:	mass
Pin	2:	TxD (+)
Pin	6:	TxD (-)
Pin	8:	CLK (+)
Pin	3:	CLK (-)
Pin	5:	RxD (+)
Pin	9:	RxD (-)

Note: The pin allocation of the input and the output of the external interface alike. The connection must be made with a 1 : 1 cable.

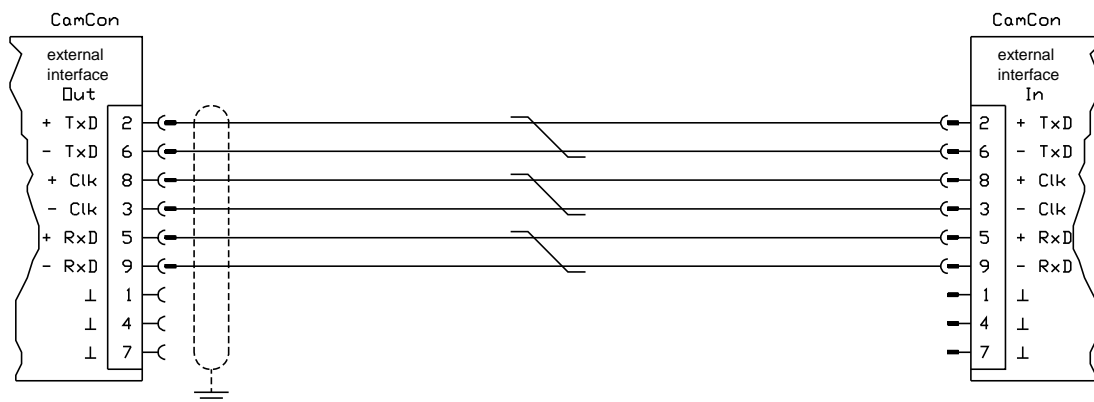

5.1.6. Pin allocation of the serial interface with 9 poles

When you task the CamCon you can choose the type of serial interface (RS232 or RS485). The pin allocation and the wiring differ with each type.

5.1.6.1. Pin allocation of the serial RS232 interface

DSUB 9 pin board: RS232 interface for PC connection (max. 15m cable length)

Pin	1,4 u. 6-9:	must not be allocated
Pin	2:	TxD
Pin	3:	RxD
Pin	5:	mass

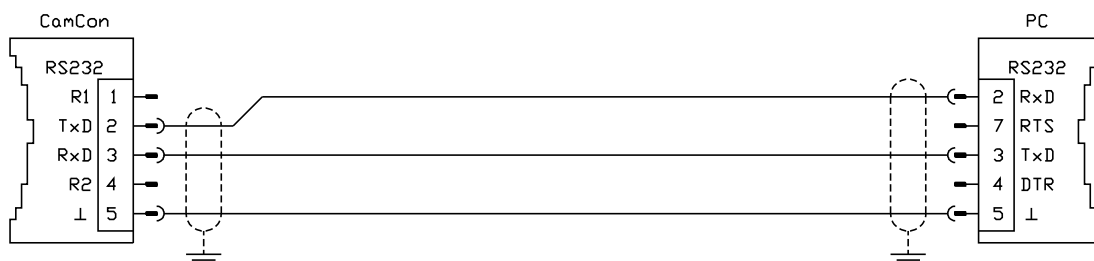

5.1.6.2. Pin allocation of the serial RS485 interface

DSUB 9 pin board: RS485 interface for PC connection or for the linking of several devices (maximum cable length 1000m).

Pin	1,4:	closedown resistors
Pin	2:	B (-)
Pin	3:	A (+)
Pin	5:	mass
Pin	6-9:	not allocated

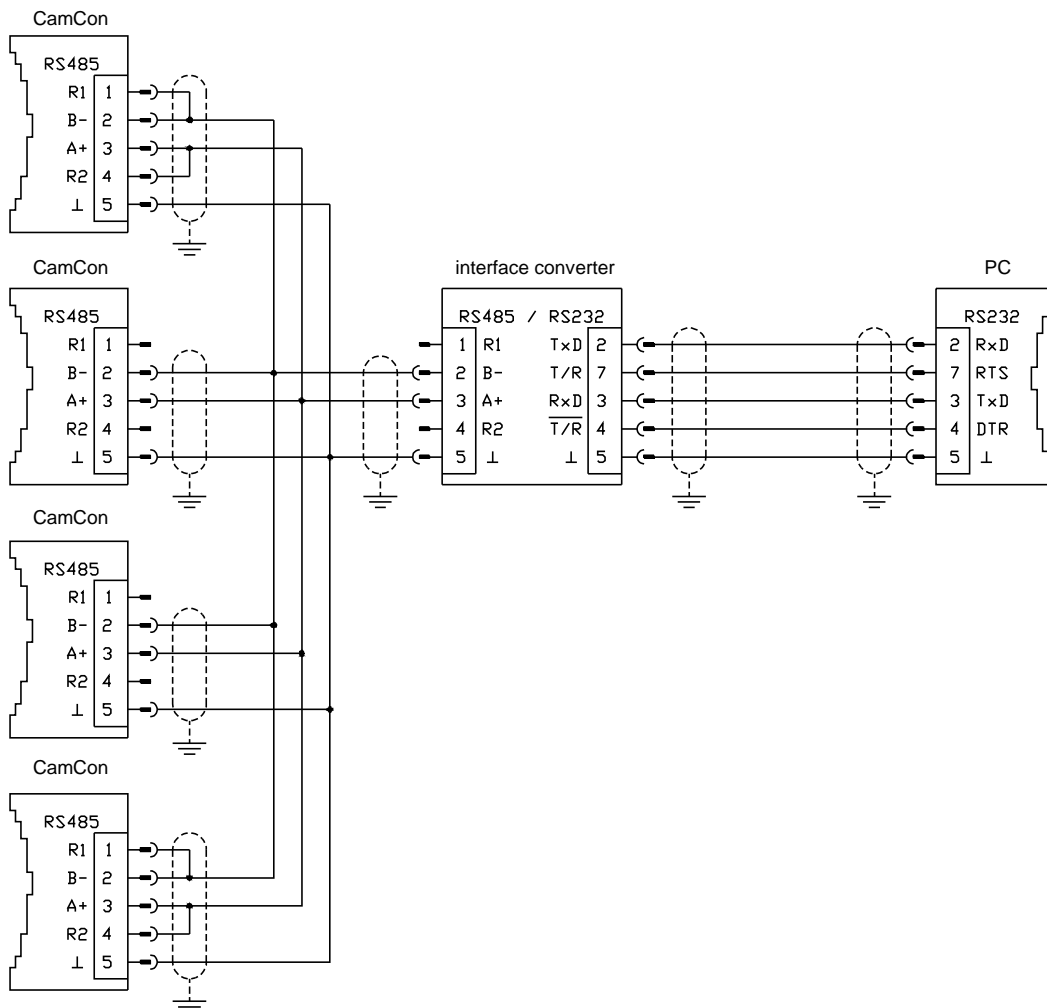
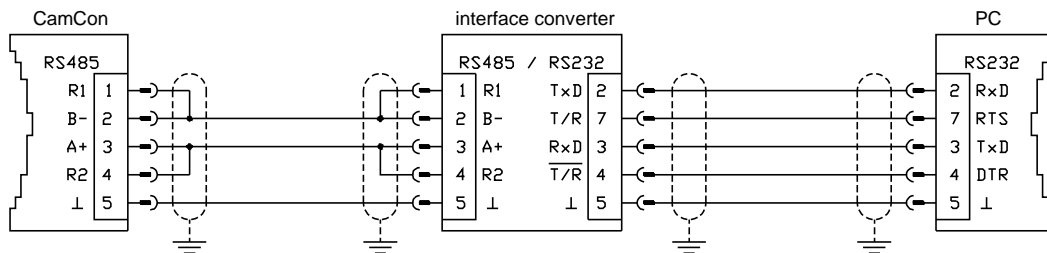

Please note: With an RS485 interface the connection plugs of the first and the last unit of a linked chain, pins 1 and 2, as well as pins 3 and 4 have to be bridged to close off the data and the input cable. Therefore the device has closedown resistors at pins 1 and 4.

5.1.7. Pin allocation of the analog output

Pin	1:	0V for analog output
Pin	2:	analog output 1
Pin	3:	analog output 2

5.1.8. Pin allocation of the inputs

The connection pins of inputs 1-16 and of the outputs 25-40 are used in two ways. If you e.g. set output 40, input 8 will also activate.

Pin	11:	0V	
Pin	12:	input 1	(output 33)
Pin	13:	input 2	(output 34)
Pin	14:	input 3	(output 35)
Pin	15:	input 4	(output 36)
Pin	16:	input 5	(output 37)
Pin	17:	input 6	(output 38)
Pin	18:	input 7	(output 39)
Pin	19:	input 8	(output 40)
Pin	20:	+24V DC voltage supply for outputs 33-40	

Pin	41:	0V	
Pin	42:	input 9	(output 25)
Pin	43:	input 10	(output 26)
Pin	44:	input 11	(output 27)
Pin	45:	input 12	(output 28)
Pin	46:	input 13	(output 29)
Pin	47:	input 14	(output 30)
Pin	48:	input 15	(output 31)
Pin	49:	input 16	(output 32)
Pin	50:	+24V DC voltage supply for outputs 25-32	

5.1.9. Pin allocation of the outputs

Pin	11:	0V	
Pin	12:	output 33	(input 1)
Pin	13:	output 34	(input 2)
Pin	14:	output 35	(input 3)
Pin	15:	output 36	(input 4)
Pin	16:	output 37	(input 5)
Pin	17:	output 38	(input 6)
Pin	18:	output 39	(input 7)
Pin	19:	output 40	(input 8)
Pin	20:	+24V DC voltage supply for outputs 33-40	

Pin	21:	0V	
Pin	22:	output 17	
Pin	23:	output 18	
Pin	24:	output 19	
Pin	25:	output 20	
Pin	26:	output 21	
Pin	27:	output 22	
Pin	28:	output 23	
Pin	29:	output 24	
Pin	30:	+24V DC voltage supply for outputs 17-24	

Pin 31: 0V
Pin 32: output 1
Pin 33: output 2
Pin 34: output 3
Pin 35: output 4
Pin 36: output 5
Pin 37: output 6
Pin 38: output 7
Pin 39: output 8
Pin 40: +24V DC voltage supply for outputs 1-8 and periphery

Pin 41: 0V
Pin 42: output 25 (input 9)
Pin 43: output 26 (input 10)
Pin 44: output 27 (input 11)
Pin 45: output 28 (input 12)
Pin 46: output 29 (input 13)
Pin 47: output 30 (input 14)
Pin 48: output 31 (input 15)
Pin 49: output 32 (input 16)
Pin 50: +24V DC voltage supply for outputs 25-32

Pin 51: 0V
Pin 52: output 9
Pin 53: output 10
Pin 54: output 11
Pin 55: output 12
Pin 56: output 13
Pin 57: output 14
Pin 58: output 15
Pin 59: output 16
Pin 60: +24V DC voltage supply for outputs 9-16 and periphery

5.1.10. Voltage supply of the CamCon

The CamCon DC115 is supplied with 5V by the BUS of the S5. The periphery has to be supplied with voltage from the outside, since it is galvanically separated from the S5 BUS. The serial interface, however, is not galvanically separated. For the periphery (external interface, encoder, analog outputs and inputs) to function, it has to be supplied +24V at either pin 40 or pin 60. The voltage supply of the outputs has to be connected for every output block (see above), because they are not connected among each other and cannot share the voltage.

5.2. The measuring system

The measuring system supplies the actual values (positions) necessary for the cam controller. You can connect all different kinds of measuring systems to the :

See also chapter "5.1. Pin allocation of the CamCon DC115" on page 18 and for the adaption of the measuring system to the software of the CamCon see also chapter "8.4.1. Measuring system" on page 46.

Note: Consult the handbook of your measuring system.

5.2.1. SSI measuring system input

Systems with serial synchronous interface = SSI. The SSI interface is a well-known interface in the industry for absolute single and multi-turn encoders. With this interface, the CamCon supplies the measuring system with 24Volt. For the readout of data, the CamCon emits a clock signal (Clock) with an RS422 level to the measuring system. The measuring system answers synchronously with the output (Data) of the position in gray code. The frequency of the clock signal depends on the cable length to the measuring system and can be set at the CamCon.

Note: The data protocol corresponds to the Stegmann SSI norm.

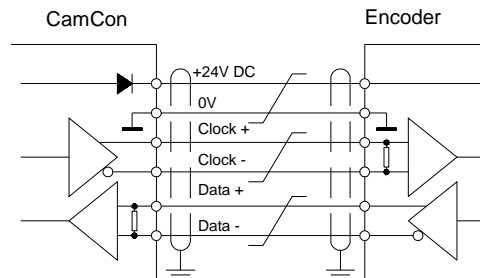
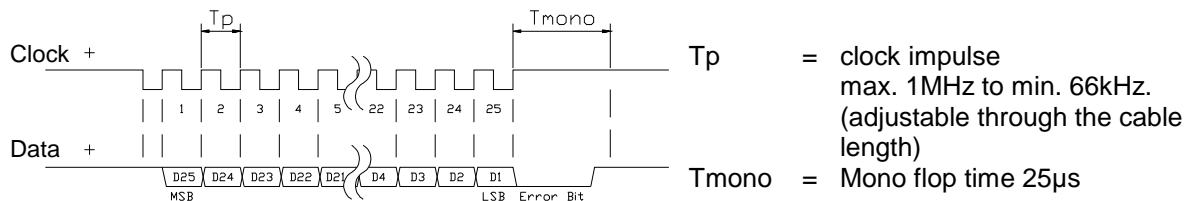

Please note:

Only use a sheathed pairwise connection cable. Do not put the cable near power current wires. If possible, put the screening up at both sides.

5.2.2. Parallel measuring system input

Systems with parallel 24V data cables. e.g. single turn encoders or changers with with parallel data output.

A gray coded value is put to the free inputs of the CamCon that is read as the actual position. Since these cables are very expensive and the EMV adaption is limited, this interface type is not used very often any more by the industry.

Note: Because the outputs of CamCons DC16 and DC115 are partially switched parallel to the inputs, they may not be programmed under any circumstances, which reduces the number of available outputs.

5.2.3. Incremental measuring system input

Systems with 90 degree phase shifting signals.
e.g. rotation encoders or gate measuring instruments.

At the time, the incremental measuring system is only available for CamCons DC16/50/51 and DC115 as an option. There are two signal levels:

- 24V PNP signal inputs (the option for the ordering number: J)
- 5V RS422 signal inputs (the option for the ordering number: I)

Note: Only the 24V PNP signals are available for the CamCon DC16.

In both cases the CamCon supplies the measuring system with 24Volt/DC or, in the case of CamCon DC115, either with 5 or 24Volt/DC. The measuring system supplies as a counter signal two impulses (A + B) (shifted by 90 degrees). These are counted by the CamCon, and the position value is calculated. It also supplies a zero impulse per rotation (Clear 1) for synchronisation purposes. To prevent the synchronisation (setting to zero) of the counter, there is a further clear signal available at the CamCon (Clear 2).

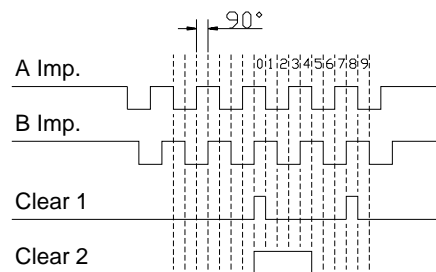

The signals Clear 1 and Clear 2 are a standard AND linked and their function can be changed through the software. See chapter "8.4.1.5.3. Inkremental-measuring system" on page 49

5.2.3.1. Incremental measuring system input with 5V RS422 level

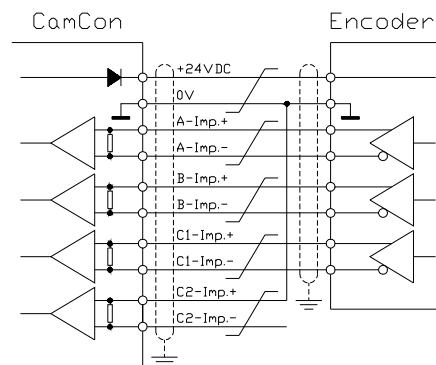

If you are using the 5V RS422 system, you have to switch all signals of the measuring system input, otherwise the input state is undefined. If there is no signal available for one of the two 'Clear inputs', this input has to be switched to mass on the (+) signal to switch this input to 'low'. The inputs of the measuring system may be connected only with a voltage of 5V max. Watch out also for the supply voltage for the encoder, that can be either 5 or 24Volt. At the time only the CamCon DC115 is able to supply a voltage of 5Volt for the encoder.

5.2.3.2. Incremental measuring system input with 24V PNP level

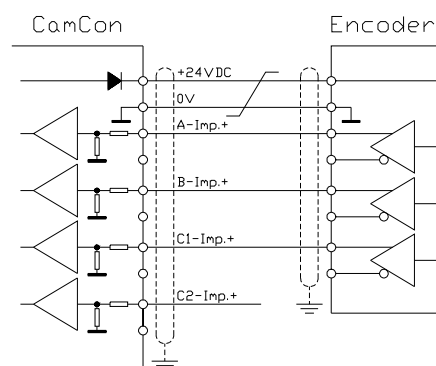

If a 24V PNP signal is used as a data input, you may only connect the (+) signals of the inputs. The (-) signals have to remain unswitched in this case. The connection of such a measuring system requires a change of the internal circuits and has to be specified with your order.

Note: There are no (-) signals at the incremental input of the CamCon DC16.

5.2.4. Analog measuring system input

Systems, that receive their actual position from changes of voltages.
e.g. temperature measurement.

For the gathering of analog signals, the CamCon uses the changer module AWA/SSI in 8 and 12 Bit resolution. This module is connected to the SSI interface of the CamCon and is activated by selecting the analog measuring system in the menu "Measuring system".

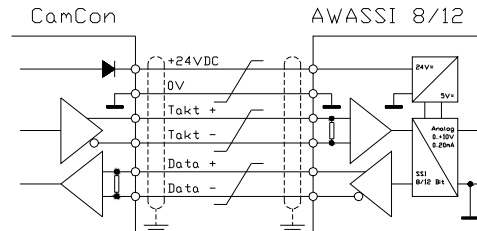

5.2.5. PLL measuring system input

Systems with Phase - Lock - Loop data-collecting, e.g. to receive the actual positions through initiator impulses using interpolation. This measuring system is used with machines that have a fixed speed and regular period.

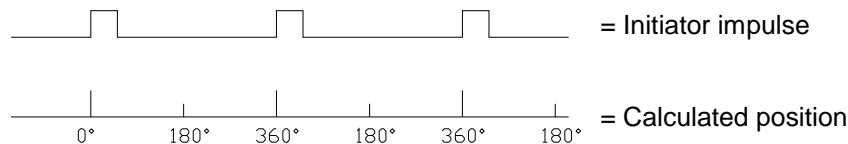

The initiator be connected to any free input of the CamCon DC16/40/50/51 or DC90.

Note: The CamCon DC115 has a special input on the SUB-D plug with 25 poles for this purpose..

See also chapter "8.4.1.5.5. PLL measuring system" on page 51.

5.2.6. Timer as a measuring system

Systems, which are directed by internal time, e.g. the time-directed sequence of a washing machine. With this option, the CamCon defines a time, with a basis of min. 1 ms, as actual position. It is possible to influence the process of time by putting signals to the inputs.

See also chapter "8.4.1.5.6. Timer way simulation" on page 51.

5.2.7. RS232 as a measuring system

Systems, receiving their actual position through the RS232 interface, e.g. for a junction of a Stegmann POMUX linear scale to a RS232 data output.



Attention: The activation of this measuring system blocks the RS232 interface for programming. This measuring system is only reasonable with a CamCon DC50/51.

5.3. The outputs

The CamCon DC115 has 40 short circuit-proof outputs. They deliver 24Volt high active signals and are potentially free to the S5 BUS. The outputs 1-8, 9-16, 17-24, 25-32 and 33-40 are separated from each other and have to be supplied separately from the outside. The outputs supply a permanent current of 0.5A. (see also chapter 8.4.6.2. Setting the outputs on page 61)

Please note: Outputs 33 - 40 share pins with inputs 1 - 8 and
Outputs 25 - 32 share pins with inputs 9 - 16



Attention: For inductive loads the inductances have to be tripped with a freewheeling diode.

5.4. The inputs

The CamCon DC115 has 16 inputs. These inputs work with high active 24Volt signals and are potentially free to the S5 BUS. The input resistance is 5.7kOhm.

Please note: Inputs 1 - 8 share pins with outputs 33 - 40 and
Inputs 9 - 16 share pins with outputs 25 - 32.

The input wiring:

The input resistance is about 5.7 KOhm.

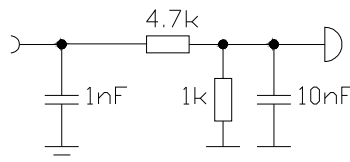

During the manufacturing, no functions are assigned to the inputs of the CamCon. This has to be done by the user during the setting of the system registers. See chapter "8.4.6. System upgrading" on page 61, chapter "8.4.1. Measuring system" on page 46, chapter "8.4.6.5. Setting the external program selection" on page 61 and chapter "8.4.6.4. Setting the keyboard lock" on page 61.

5.5. Safety precautions during welding operations



Attention: For the duration of welding operations carried out at the machine, the connecting wires concerning the data exchange from the measuring system to the CamCon and the power supply as well as the grounding connections and inputs and outputs have to be separated from the CamCon.

5.6. The status LED

The status LED of the CamCon shows the different blinking intervalls of the the device state. This way, the operation state of the device can be seen without a PC or a terminal.

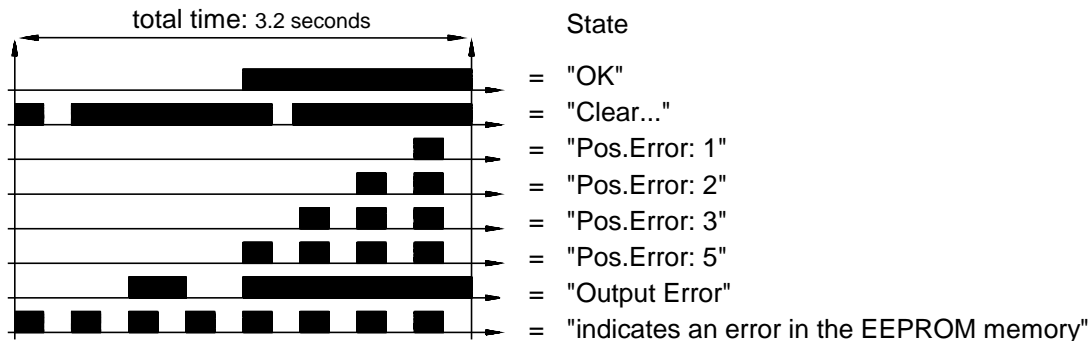

See also chapter "10. Error messages and error recovery" on page 74.















The status LED (red) of the CamCon DC115 is on the board behind the plug for outputs 33 - 40.

6. General programming information



To program CamCon units without integrated input devices (CamCons DC16/90 and CamCon DC115) you can use any IBM or compatible PC with a VGA monitor, harddisk, serial interface and an MS-DOS version of at least 3.3. Also required are the program DIGISOFT for CamComs DC16/40/50/90/115 and a connection cable; in case of an RS485 interface, you also need a level converter. There is also the possibility to do the programming with a CamCon DC50/51 or a CamCon CT10 terminal. All of the following operations and functions have references to the inputs made with the PC software or the CamCon DC50/51 (CT10) terminal, i.e. the key commands of the PC or the CamCon DC50/51 terminal are transmitted to the CamCon unit via the serial interface. As a return, the display of the CamCon unit is sent to the PC or the CamCon DC50/51 terminal.

The programming via the Kachel - handling is described in chapter "14. Kachel communication" on page 80. The programming of the variable parameters of the CamCon DC115 is possible via the Kachel interface and the serial interface.







6.1. Outline of key functions

	cursor down
	cursor up
	cursor to the left, shifting cams
	cursor to the right, shifting cams
	choose cam activation point, character selection during text input, (or PC 'PageUp' key)
	choose cam deactivation point, character selection during text input (or PC 'PageDown' key)
	input of cams, special measuring systems, character during text input
	place holder for display formats, reset during error messages, special functions
	Escape: leaving the current menu, returning to the next higher menu
	deletion of cams, outputs, programs and single characters during text input
	deletion of single characters during text input
	confirm input and save data
	changes the algebraic sign during data input
	comma
	numeric keys for data input









6.2. Menu selection



You can select a desired menu by pressing the corresponding numeric key or by moving the cursor (the black beam) on the menu name with keys  and  and pressing the  key.







6.3. Selection of a menu point

The input in the single menus is subdivided into menu points. These are active (or selected), if the display is inverted. The selection of these menu points is made with keys , ,  and  and a confirmation of your choice with the  key. You can always cancel an input by pressing the  key. If you pressed a wrong key, the unit shows a hint of the keys you can use in this menu and their functions.

6.4. Text input

With menu points, in which texts have to be implemented, the  and  keys function together with the  and  keys like a coordinate control. You select the desired position for the first character, using the  and  keys. Then you can choose the character with the  and  keys, by going up and down through the alphabet or the ASCII characters. If you move the cursor to the right with the  key, character entered prior to this will appear in the new position of the cursor, simplifying making repeated inputs of the same character.

If you have made an error you can go back to the wrong character to correct it, using the  key or the  key. This will cause the other characters to become erased. To abandon the input press the  key.

Attention: The software for the text input at the CamCon has changed since EPROMS of 1/97. The selectio of desired characters is now realized with keys  and . With keys  and  you can now position the cursor anywhere in the previously entered text. You can overwrite characters, insert characters by pressing the  key or delete characters with keys  or .

Note: The text input is also possible directly through the PC.

7. Commissioning

Please check the wiring of the CamCon before the first activation. Please see chapter "5.1. Pin allocation of the CamCon DC115" on page 18.



Attention: In the case of inductive loads, switch the outputs with a free wheeling diode. Covers or inductivities in the switchboard, near to the CamCon unit or influencing it or its wiring, have to be switched with a deletion unit.



After the activation of the voltage supply, the unit emits a short tone. Then it will perform internal tests (e.g. calculating the proof total of EPROM and EEPROM) and start the system. This process takes several seconds. Once this process is finished, the Kachel is initialized on the S5 BUS. In this preliminary phase, the S5 CPU may not contact the Kachel, having to wait until the initialization process is complete (about 2 - 3 seconds).

After first activating the supply voltage, the program memory is not in a defined state. So when first using the CamCon unit you have to put a complete deletion into operation as follows:

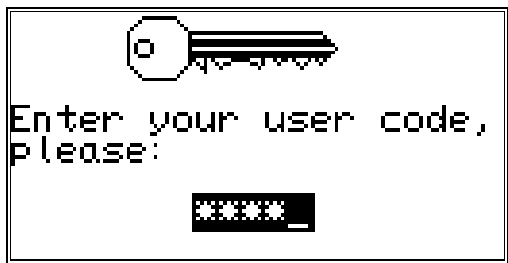
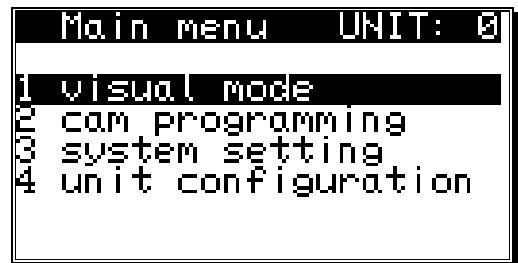
1. Press the  key, you leave the standard display and enter the main menu:
2. Select the menu point "Unit configuration", the request to enter your user code is displayed on the LCD:





3. Enter your user code. If you have not programmed your own key, use the standard key number "5693"!

4. Press the  key to confirm your user code. If a false code is entered, "Wrong user code!" is shown on the display. In this case, press any key, and reenter the code. The display returns to the main menu after about 30 sec., if no numbers are entered or the input is not confirmed with the  key.

After the correct user code is entered, the display shows the configuration menu.

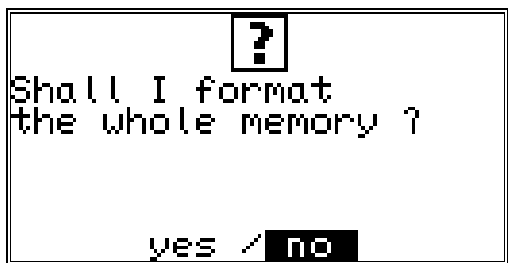
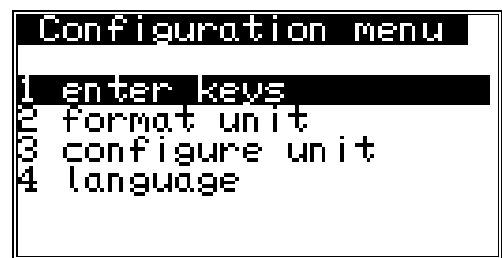
5. Select the menu point "Format unit", the following question is displayed:



6. Move the cursor to "yes" with the  key.
7. Press the  key.

After about 5 sec. the display returns to the configuration menu. This waiting time depends on the size of the used EEPROM, since the memory has to be formatted. With the use of a 32k - EEPROM it is increased to approximately 2 min. After this time the complete deletion is finished. All cams are erased, all system registers have the standard value.

Now you can begin with the system setting.

To make your device operable, you have to set a minimum number of parameters on your CamCon. This is the recommended order of the parameterization. You can find the necessary information in the corresponding chapters.

- 1) System setting, System upgrading See chapter "8.4.6. System upgrading" on page 61.
- 2) System setting, Cable length See chapter "8.4.4.1. The cable length" on page 57.
- 3) System setting, Measuring system See chapter "8.4.1. Measuring system" on page 46.

If you have adjusted the inputs according to the corresponding chapters, the CamCon is ready and no more error messages should occur. Of course we recommend to go through the whole system setting menu to receive a maximum of user ability and comfort.

After the system setting you can begin with the cam programming.

8. Operation of the CamCon

8.1. The main menu

The programming always starts at the main menu. No matter in which state of programming you are, you can always reach the main menu by pressing the **ESC** key (several times, if necessary).

By pressing the corresponding number or by selection with keys **▼** and **▲** and a verification with the **CR** key, you can enter the submenus.

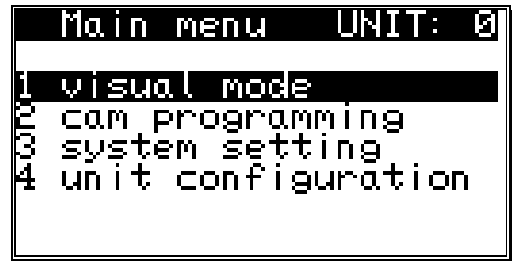

8.2. The standard display

You reach the submenu for the display for normal operation of the cam controller via the main menu point "Visual mode" or by pressing the **ESC** key (at the main menu).

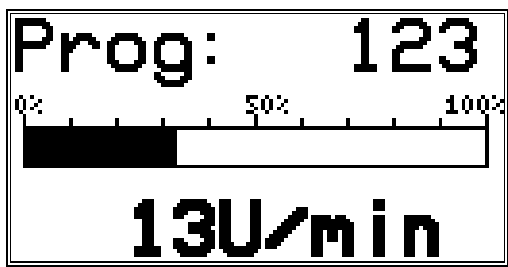

In the display menu, the active program number, the relative speed as a bar (e.g. for an analog speed output) and the current actual position, respectively the absolute speed (with higher rotational numbers), are displayed. If the measuring system is put into a slow motion the respective actual position is shown on the display. With increasing rotation velocity the device switches at a defined point (5%) to a display showing the current speed in the desired representation; a negative direction in the rotation is shown through a negative sign in front of the

displayed value.

The configuration of the speed display is done in the system setting menu. Here you can e.g. disable the automatic change of the display, by selecting a certain display type (see chapter "8.4.3. The speed adjustment" on page 55).

8.2.1. Changing the display

If you want to receive status information of in- and outputs during operation, you can switch through the several status displays, using keys **◀** and **▶**. The display then shows an outline of operation for inputs and outputs:

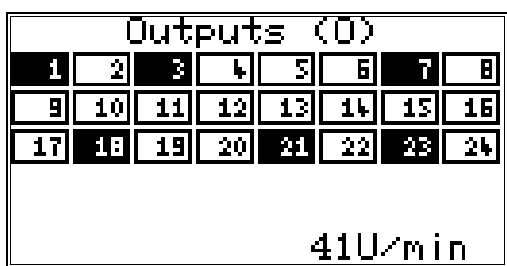

Output display

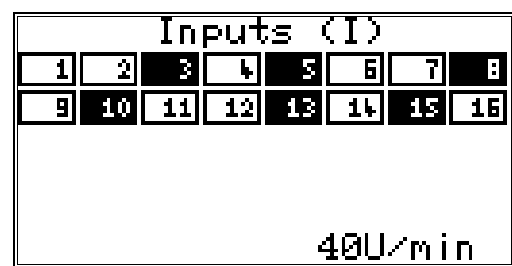

Input display

As soon as an in- or output activates, its field on the display turns black.

In the lower righthand corner of the display, you can see the current position or the absolute speed at a faster movement.

8.2.2. Program change

With the CamCon you are capable of storing several programs. To choose one of these programs you have to be in the standard display. The selection of a desired program is done as follows:

1. Press the **CR** key, the display shows the request for your user code.
2. Enter your user code.
3. Press the **CR** key, the cursor goes to the menu field of the program number.

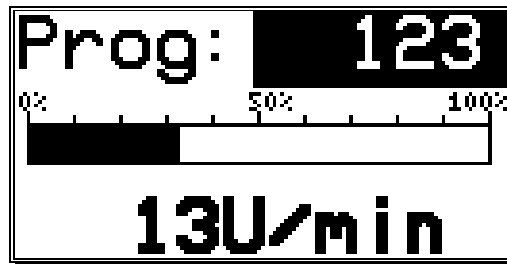

4. Enter program number with the numeric keys
5. Press the **CR** key to complete your input

The CamCon will change programs according to the program selection parameters you entered. If the process takes longer than one second, the display will blink until the selection is complete see chapter "8.4.6.6. Setting the program selection mode" on page 62.

8.2.3. Program name

With the CamCon you can assign a text to the stored programs. This is recommended when important information needs to be linked to the program number (e.g. a toolnumber or the name of a product). The input of the program name is done as follows:

1. Press the **CR** key, the display shows the request for your user code
2. Enter your user code
3. Press the **CR** key, the cursor goes to the menu field of the program number
4. Press the **#** key, the cursor goes to the text input of the program number

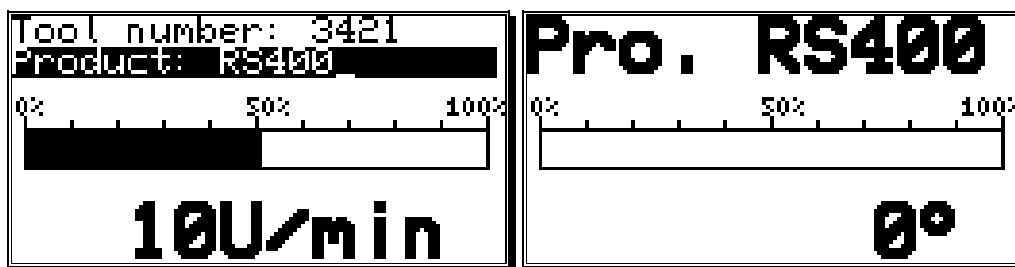

Here you can enter a name for your program (see chapter "6.4. Text input" on page 29).

5. Confirm your input with the **CR** key

The presentation of the program name changes with the length of the input text. 2 lines with 21 characters each or 1 line with 10 characters can be displayed.

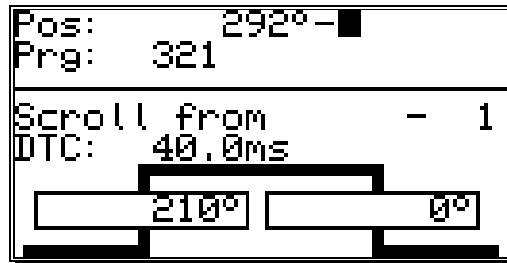

8.3. Cam programming

To get to the actual cam programming select "**Cam programming**" in the main menu. The display switches to the programming menu:





The upper part shows the current actual position, the switched state of the selected output and the chosen program. The lower part displays an output with programmed cams and their activation and their deactivation points. If no input is made within two minutes the CamCon automatically returns to the main menu for reasons of safety.

8.3.1. Output selection for programming

You can select the desired output by pressing the  and  keys.

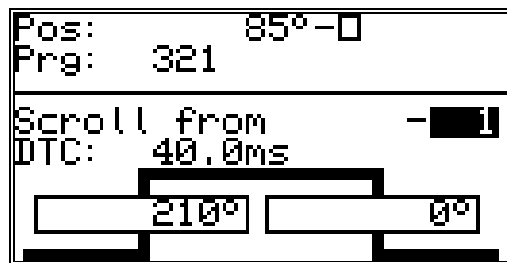
By pressing the  key you reach the direct input of the output number.



With the numeric keys you can select the number of the output you want to select. Confirm your selection with the  key.

8.3.2. Program selection for programming

You reach the input of the output number by pressing the **CR** key. You skip this by pressing the **▲** key and enter the program selection for the programming.

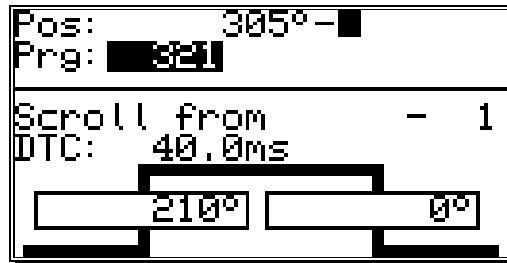

Enter the number of the desired program by using the numeric keys. Confirm your input with the **CR** key.



A change in the program number does not lead to a change in the momentarily active cam program. This means: You can program a program while another program operates the outputs.

8.3.3. Programming the dead time compensation

You reach the input of the output number by pressing the **CR** key. You skip this by pressing the **▼** key and enter the dead time you want to compensate.

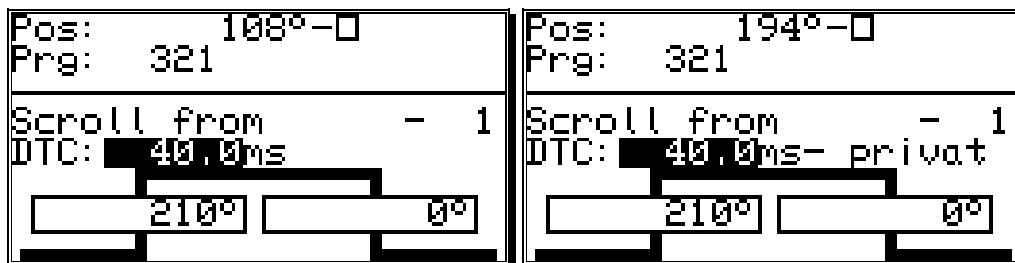

With the numeric keys you can enter the dead time that you need to compensate.

By pressing the **#** key with the input you can limit the effect of the dead time compensation to the program you are programming (private). A renewed pressing of the **#** key takes on the standard dead time compensation for this program.

Confirm your input by pressing the **CR** key.

References to the way dead time compensation works can be found in chapter "2.1. Dead time compensation" on page 9.

8.3.4. Programming the output name

You reach the input of the output number by pressing the **CR** key. You skip this by pressing the **◀** key and enter the input of the output name of this output.

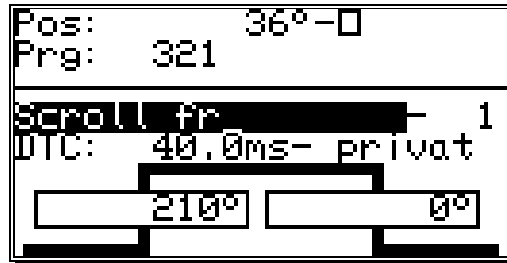

Here you can enter the output name via text input see chapter "6.4. Text input" on page 29.

8.3.5. Cam Input

By pressing the **↵** key you start the input of a cam. On the display the field for the cam activation point (left bar) is underlined in black, while a stylized cam blinks in the range of the two bars. With the numeric keys you enter the position for the cam activation point.

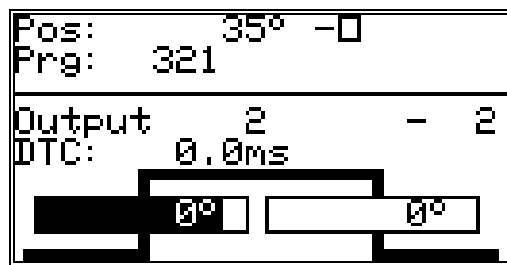

After you confirm your selection with the **CR** key, the field for the cam deactivation point is underlined in black. Simultaneously, the dropping flank of the stylized cam starts to blink.

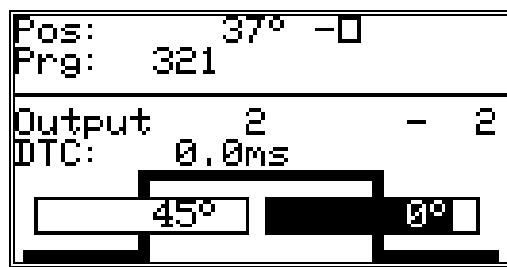

Enter the value for the cam deactivation point with the numeric keys and finish your input with the pressing of the **CR** key.

Remember: The maximum expansion of a cam can never reach a full rotation. For the programming of such a cam you have to program a security output (see chapter "8.4.5. The special outputs" on page 57).

8.3.6. Adding cams

In case you want to program additional cams on this output, you have to use the **INS** key. When you press this key the following is displayed on the display:

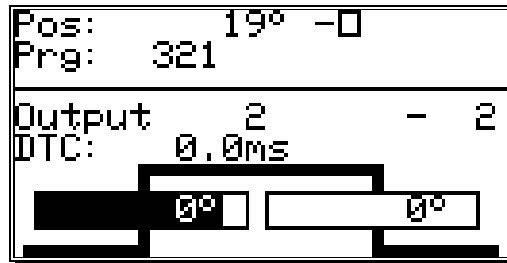

Here you can enter the positions for the activation and the deactivation point for the cam, as is described in the chapter "8.3.5. Cam Input". If you enter a cam that overlaps with an already existing cam, you create a single, greater cam.

Example: The previously configured cam lies between 50 and 120 degrees. If you now create a new cam between 90 and 180 degrees, these two cams are combined into a new cam from 50 to 180 degrees.

8.3.7. Cam Teach - In

If you are in an input field of an activation or deactivation point during cam programming, you can assume the current actual position for the field by pressing the **#** key. The actual position is displayed and brought up to date until the **↵**, **↶**, **CR** or **ESC** key is pressed to confirm the value or to abort the input.

8.3.8. Cam Search

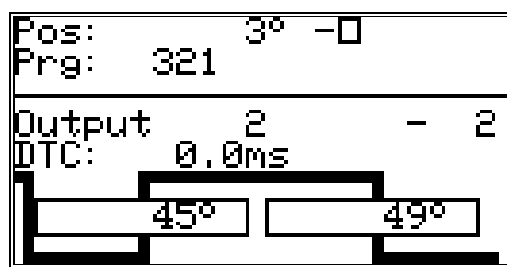

With the **◀** and **▶** keys you can call up and control the programmed cams. With each activation a single cam is displayed, and its neighbouring cams are shown as their flanks on the edges of the display.





The increasing course of the cam curvature on the right edge of the display points to another cam that is positioned between the cam deactivation point (180°) and the higher border of the measurement range (e.g.:359°). The left flank hints to the presence of additional cams between the cam activation point (45°) and the lower border of the measurement range (e.g.:0°).

With the **◀** and **▶** keys you can determine whether there are other programmed cams.

8.3.9. Cam deletion

If you want to completely erase a cam, select the cam using the  and  keys and press the  key, causing the following question to be displayed:



To delete the cam, move the cursor to "yes" with the  key, and press the  key to confirm your choice.

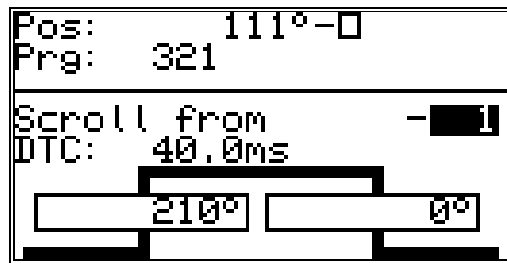

8.3.10. Output (cam track) deletion

If you want to completely erase an output (cam track), you have to press the  key to enter the input of the output number.

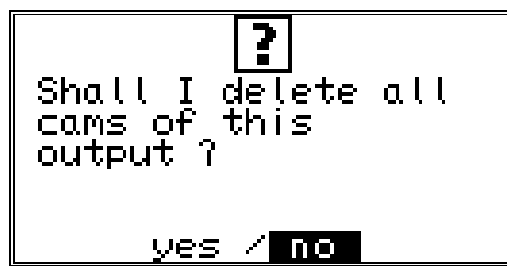

Now you can enter the number of the output you want to delete with the numeric keys. Press the  key and the following question is displayed:



Move the cursor to "yes" with the  key and press the  key to confirm your input.

8.3.11. Copying programmed outputs (cam tracks)

With the CamCon you have the option to copy all the cams you have programmed on one output to additional outputs. First press the **CR** key to enter the input of the output number. Select the output that you want to copy to the previous selected output with the numeric keys. Press the **#** key to start the copying process. The following question is displayed:

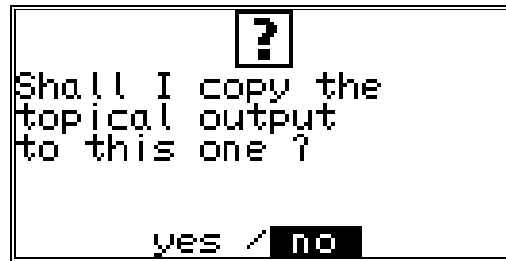

Move the cursor to "yes" with the **←** key and press the **CR** key to confirm your input. This starts the copying process. After a short while the new output will appear on the display.

8.3.12. Shifting cam tracks

With the CamCon you have the option to shift all the programmed cams of one output, using the **←** and the **→** key.

Press the **↵** or the **↵** key to enter the input of the activation or the deactivation point.

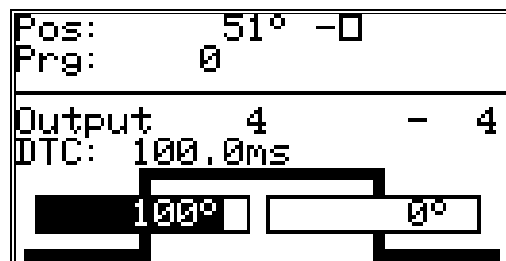

If you now press the **←** key or the **→** key, all the cams of this output are shifted by one increment. In this case the cams are directly taken over into the memory without the use of the **CR** key (unlike before). The shifting process is ended by pressing either the **CR** key or the **ESC** key.

8.3.13. Deleting programs

If you want to erase a whole program, you have to press the **CR** key to enter the input of the output number. Skip it by pressing the **▲** key, and you enter the program selection for programming.

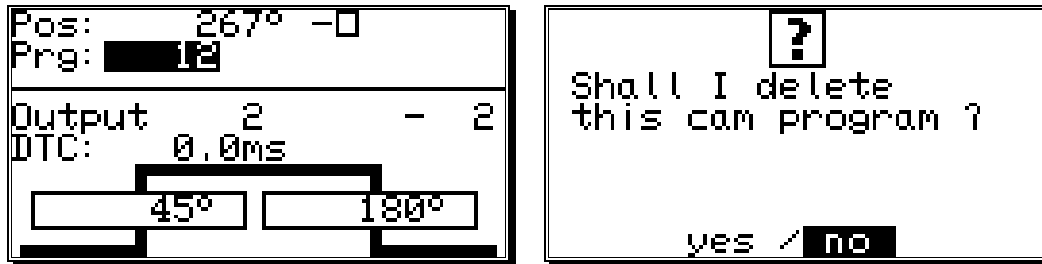

Enter the number of the program that you want to delete with the numeric keys. Press **DEL** and the display shows the security precaution question for the deletion of programs. Move the cursor to "yes" with the **◀** key, and press the **CR** key to delete the program.

8.3.14. Copying programs

With the CamCon you also copy whole programs. This is done as follows:

1. Press the **CR** key, the cursor moves to the input of the output number.
2. Press the **▲** key, the cursor moves to the input of the program number.
3. Select the program you want to copy using the numeric keys.
4. Press the **CR** key to confirm your selection.
5. Press the **CR** key, the cursor moves to the input of the output number.
6. Press the **▲** key, the cursor moves to the input of the program number.
7. Using the numeric keys, select the program onto which you want to copy the previously selected program.
8. Press the **#** key, to start the copying process. The display shows the question:

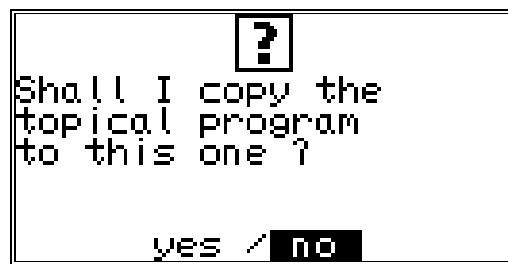

9. Move the cursor to "yes" with the **◀** key and press the **CR** key to confirm your input.

This finally initializes the copying process, and after a short while the new program appears on the display.

8.3.15. Examples for cam programming

8.3.15.1. First cam programming

Task: After a complete deletion of the program memory and a successful initialization of the system, a cam shall be programmed for output 4 from 100° to 200° with a dead time compensation of 100ms

```

Pos: 123° -■
Prg: 0

Output 1 - 1
DTC: 0.0ms
    
```

```

Pos: 231° -□
Prg: 0

Output 1 - 4
DTC: 0.0ms
    
```

```

Pos: 51° -□
Prg: 0

Output 4 - 4
DTC: 100.0ms
    
```

```

Pos: 51° -□
Prg: 0

Output 4 - 4
DTC: 100.0ms
100° 0°
    
```

```

Pos: 183° -□
Prg: 0

Output 4 - 4
DTC: 100.0ms
100° 200°
    
```

```

Pos: 185° -■
Prg: 0

Output 4 - 4
DTC: 100.0ms
100° 200°
    
```

Solution:

1. Choose the main menu point "**Programming**".
2. Enter your user code and press the **CR** key, to have the programming menu displayed.
3. Press the **CR** key and enter "4".
4. Press the **▼** key, the cursor moves to the field for dead time compensation.
5. Enter the value "1000" with the numeric keys.
6. Press the **↵** key to enter the cam activation point. The cursor moves to the input field for the cam activation point. Simultaneously, a stylized cam point starts blinking.
7. Enter the value "100" for the cam activation point with the numeric keys.
8. Press the **↵** key. The cursor moves to the input field for the cam deactivation point.
9. Enter the value "200" for the cam deactivation point with the numeric keys.
10. Press the **CR** key to confirm your input. The first cam is now programmed.
11. You can leave this menu any time by pressing the **ESC** key.

8.3.15.2. Programming additional cams on an output

Task: Program an additional cam from 300° to 330° in program 0, on output 4 with the cam from 100° to 200°.

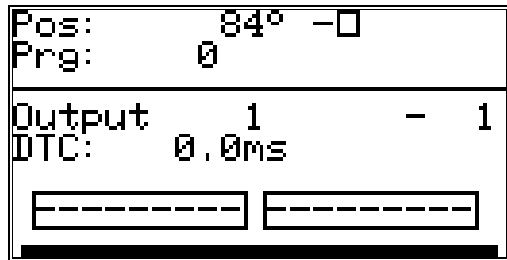

Solution

1. Select the menu point "programming" in the main menu.
2. Enter your user code and press the **CR** key. The programming menu is displayed:

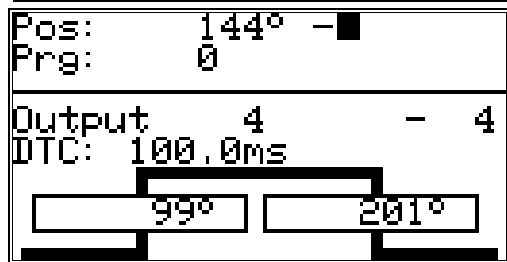

3. Select output 4 with the **▲** key or press **CR**, enter "4" and press the **CR** key again.



4. Press the **INS** key to enter the cam activation point for an additional cam. The cursor moves to the input field for the cam activation point; a stylized cam starts to blink simultaneously.
5. Enter the value "300" for the cam activation point by using the numeric keys.

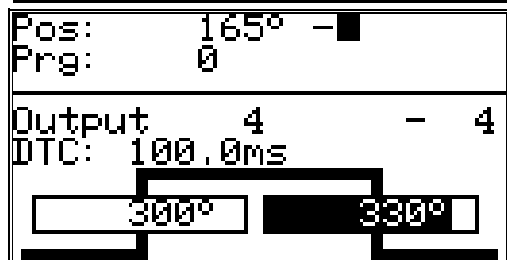

6. Press the **L** or the **CR** key. The cursor moves to the input field for the cam deactivation point.
7. Enter the value "330" for the cam deactivation point by using the numeric keys.

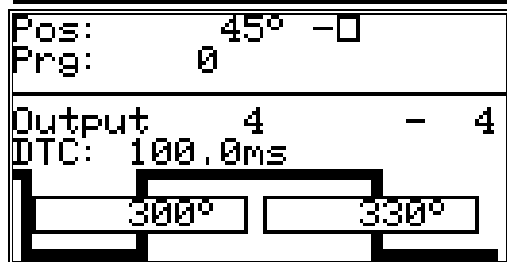

8. Press the **CR** key to confirm your input. The second cam is programmed.

The display shows the newly programmed cam as well as the cam between 100° and 200° as a flank on the left edge of the display.

9. You can leave this menu at any time by pressing the **ESC** key.

8.3.15.3. Deletion of a particular cam

Task: In program 0 the inserted cam between 300° and 330° shall be erased.

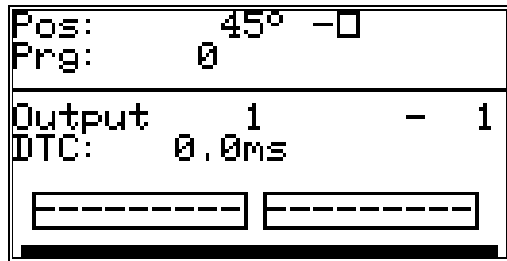

Solution:

1. Select the menu point "cam programming" in the main menu.
2. Enter your user code and press the **CR** key. The programming menu is displayed.

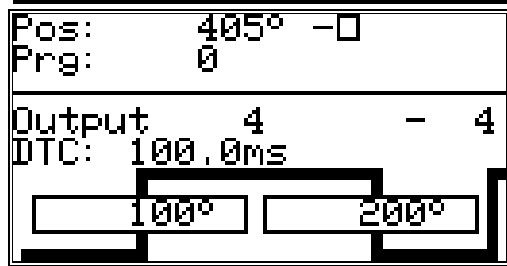

3. Select output 4 with the **▲** key or press **CR**, enter "4" and press the **CR** key again.

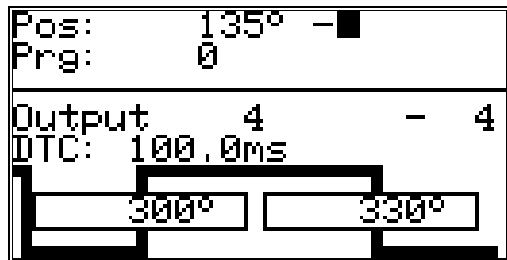



4. Select the inserted cam with the **▶** key.



5. Press the **DEL** key. The display shows the following question:

6. Using the **◀** key, move the cursor to "yes".
7. Press the **CR** key to confirm your input. The cam between 300° and 330° is erased.

8.3.16. Programming analog cams

If your CamCon is equipped with analog outputs, and you have activated the option of analog cams (see chapter "8.4.5.7. Configuration of the analog cams" on page 59), the last "normal" output will be displayed as the first analog output after pressing the . If several analog outputs are programmed, you can choose the next output number by pressing the  key.

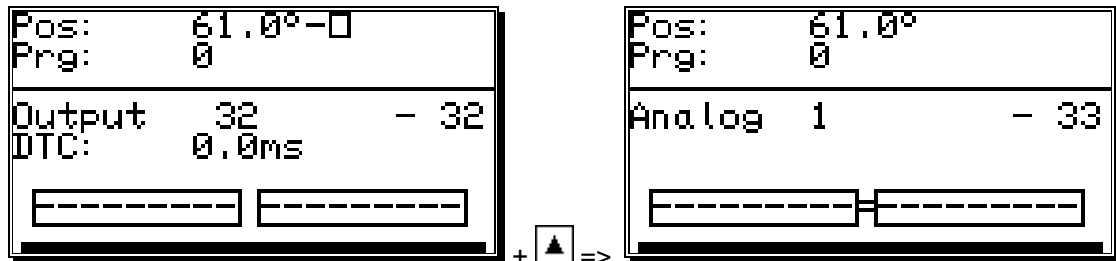

The output numbers of the analog cam outputs are always added to the numbers of "normal" outputs and this number can be selected directly from the programming menu. If you have configured e.g. 32 cam outputs, the number of the first analog cam starts at the output 33. The output number of the analog cam changes automatically when you change the number of "normal" outputs (see chapter "8.4.6.2. Setting the outputs" on page 61).

The programming of the analog cam is **mostly** done as described in the chapters for "normal" cam programming (see chapter "8.3. Cam programming"). For analog outputs, you do not program a position as a deactivation point, but an analog value. If several such values are programmed at different positions and the measuring system starts to move, CamCon controls the analog output in such a fashion, that a curve is done, corresponding with the drawing below.

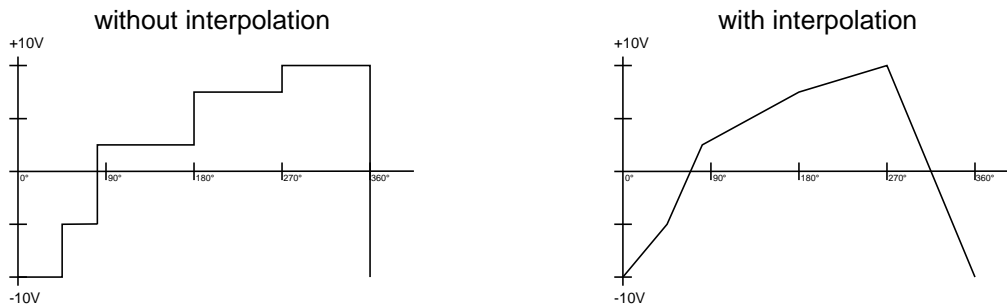

Through interpolation of the definition points, CamCon can adjust the values and present a curve, corresponding to the above right drawing.

8.3.16.1. Creating the first analog cam

To program your first analog cam, choose the program and the desired output for programming (see chapters: "8.3.2. Program selection for programming" and "8.3.1. Output selection for programming"). Press the **↓** key and enter the position value for the first definition point. Now press the **CR**, enter the analog value and confirm your input with the **CR** key.

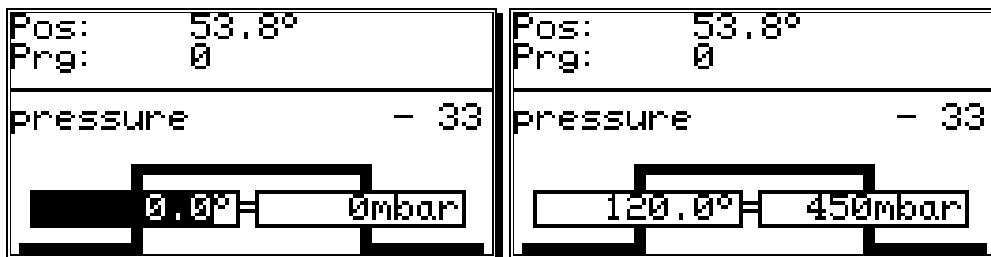

Note: As long as only one cam is programmed on a cam track, the programmed analog value is emitted for the whole way of the measuring system.

8.3.16.2. Adding an analog cam

To add another definition point, choose a desired output, press the **INS** key and enter a new position value. Press the key **CR**, enter the analog value and confirm your input with the **CR** key.

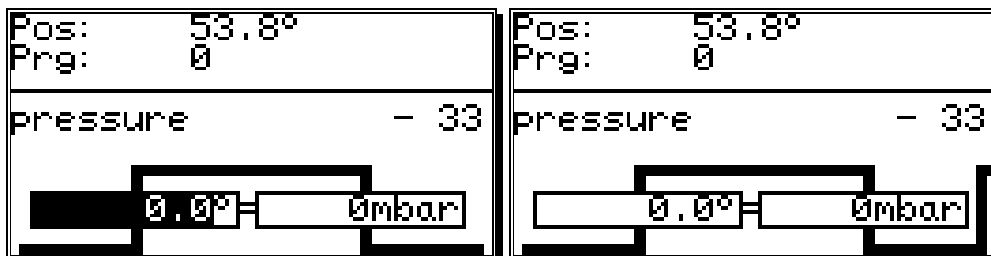

Further cams are added with the same procedure.

8.3.16.3. Changing the analog cam

To change or delete an analog cam, proceed as described in chapters "8.3.8. Cam Search", "8.3.9. Cam deletion" and "8.3.10. Output (cam track) deletion".

Note: The programming of a dead time, the copying of an analog cam track and the shifting of the complete cam track is not possible at the time.

8.4. Unit configuration (system setting)

Before you are able to use this device, you have to give it all the information about the parameters of your measuring system. Select the menu point "System setting" in the main menu. The display shows the system setting menu:

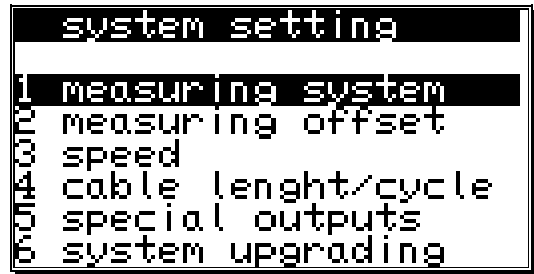

8.4.1. Measuring system

When you select the menu point "Measuring system", the display changes to the measuring system menu:

Here you can configure the measuring system, the resolution, the electronic gear, the actual position hysteresis, the rotation direction and the display format of the actual position, as well as a special measuring system. Additionally, the menu point "Position:" always shows the actual position of the CamCon. See also chapter "5.2. The measuring system" on page 23.

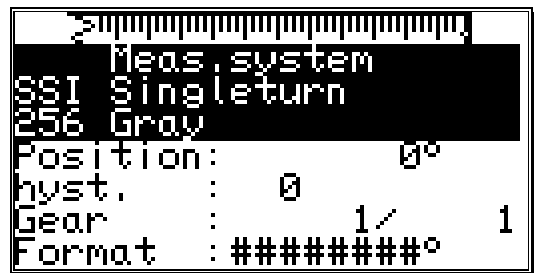

8.4.1.1. The standard measuring systems

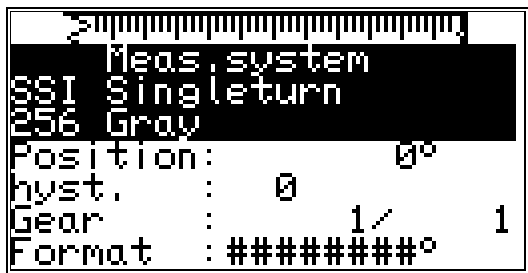

The display gives the resolution of the measuring system in steps per rotation. Generally the CamCon works with a rotation angle coder that has a resolution of 360 steps per rotation. In this case a change in the input value is superfluous. Otherwise the CamCon can be adjusted to the measuring system with the and keys. You can choose between the following predefined resolutions, that are all in accordance with common rotation encoders: 256, 360, 512, 1000, 1024,

2048, 4096 and 8192 steps. Should you not be able to set values in higher resolution ranges, it is because there is not enough memory available. If this is the case you have to extend the memory of the device. Also, you can configure two analog SSI changer modules, AWA/SSI/8 and AWA/SSI/12, for the gathering of analog signals. These modules are connected to the SSI port of the CamCon.

Note: Should you not be able to set values in higher resolution ranges, it is because there is not enough memory available. You will need to upgrade the memory of your device. See also chapter "13. Calculation of the RAM memory" on page 79.

8.4.1.2. The actual position hysteresis

At the menu point "Hyst." you enter the actual position hysteresis.

This value is needed to suppress the flashing of the outputs during uneven data gathering. The exact value can only be determined through experiments, though it should be as small as possible or always "0". The hysteresis can be between 0 and 1/4th of the total resolution, but can never exceed 255 impulses.

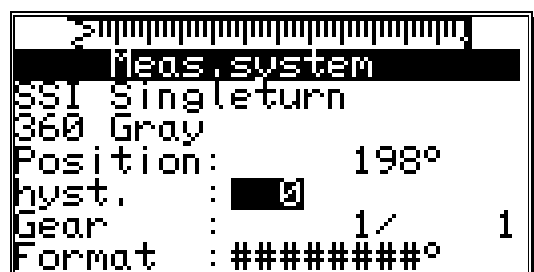

8.4.1.3. The electronic gear

In the menu point "**Measuring system**" a factor for a measuring range transformation can be entered. Through this the physical measuring range e.g. of a rotation encoder is transformed into a new, for the user effective visible measuring range. Generally this transformation has the relation 1:1. The first value represents the multiplier of the actual position, while the second value stands for the divisor through which the result of the previous multiplication is divided. The result of this operation is the display value. A negative value in the field of the multiplier changes the direction of the rotation of the measuring system. To switch the algebraic sign press the \pm key during the input of the multiplier.

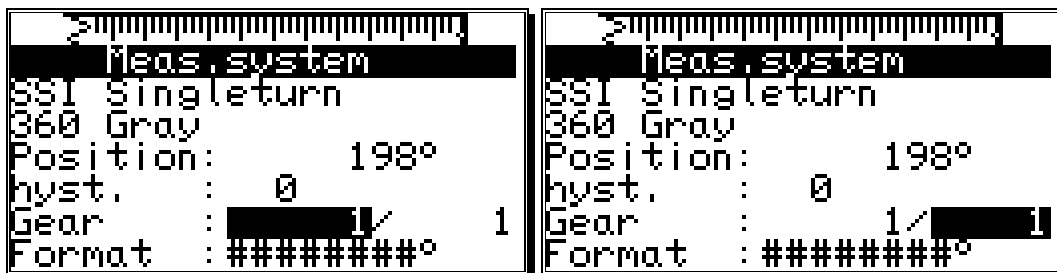

Example: At a full rotation of a rotation encoder with 360 steps per rotation a machine proceeds for 1000mm. If the display of the position is to be shown in mm rather than in angular lines, you have reset the gear with the factor **1000 / 360**. The display will no longer change in single steps, since the resolution remains unaffected. If you choose e.g. **100 / 360**, the actual position is calculated down to a proceeding range of 100. The position display is carried out in cm, but a floating point representation is not possible.

8.4.1.3.1. Electronically changing the rotation direction

The direction of the rotation of the measuring system is set at the multiplier of the electronic gear by changing its algebraic sign. Press the \pm key during the input of the multiplier. See the chapter "8.4.1.3. The electronic gear".

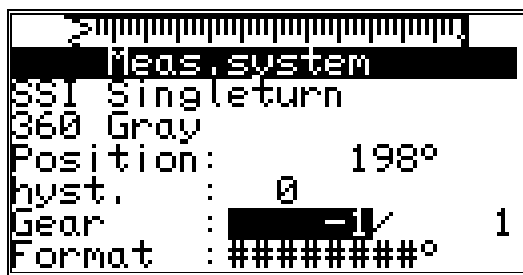

8.4.1.4. The display format of the actual position

In this menu point you can set the format for the display of the actual position.

The three # are the place holders for the number value of the display. You can enter additional comments and the unit of the measured value, e.g. mm, cm or inch with linear systems. See chapter "6.4. Text input" on page 29. If you want to display a decimal point, you can insert one between the place holders (e.g.: ###.##mm).

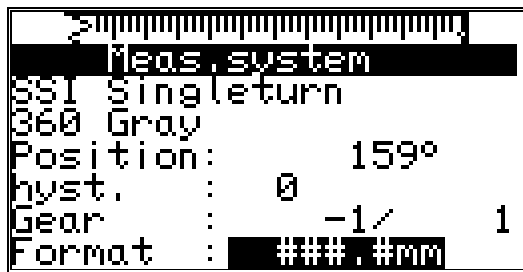

8.4.1.5. Configuration of a special measuring system

You have the possibility with CamCon to configure a special measuring system, according to the following steps:

1. To configure the special measuring system press the **INS** key. The menu for the input of a new measuring system appears on the the display.
2. Enter the measuring system description. See chapter "6.4. Text input" on page 29.
3. Presss the **CR** key to end the input of the first line. The cursor moves to the next line.
4. Enter additional text (if desired).
5. Press the **CR** key to end the text input. The cursor moves to the next menu point, "**Measuring system**".
6. Select the type of the measuring system with the **◀** and **▶** keys.
7. Press the **CR** key to confirm your input. Now the menu for the measuring system chosen by you is created. The following chapters discribe the different measuring systems and their settings.

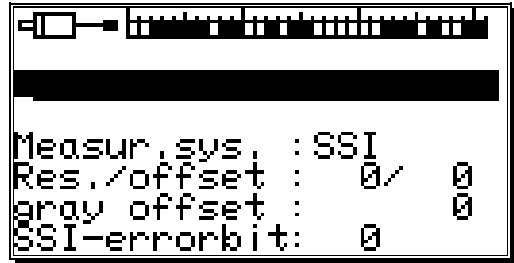

8.4.1.5.1. SSI measuring system

If you selected "**SSI**" for your special measuring system in the measuring system input, the following menu is created:

1. Enter the bit number of the resolution of the SSI measuring system
A resolution of e.g. 500 impulses corresponds with 9 bits.
2. Now enter the position of the lowest-situated bit (LSB).
In our example the LSB would be on 9th position. You can get more specific information from the manufacturer of your measuring system.
3. Now enter the cut of the measuring system code.
In our example this would be $(512 - 500) / 2 = 6$.
4. Finally you have to enter the position of the SSI - errorbit of the measuring system. With standard rotation encoders of the firm Stegmann this position is 14. Always transfer a 0 to this position.
5. Press the **CR** key to confirm your inputs and exit this menu.

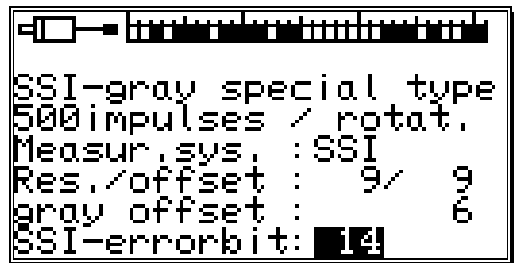

Attention: *The position of the data bits can be seen in the graphic in the upper part of the display. You can determine the positions of the LSB, HSB and errorbits quite easily by moving the measuring system.*

8.4.1.5.2. Parallel Gray measuring system

If you selected "PARAL." for your special measuring system in the measuring system input, the following menu is created:



1. Enter the resolution of the parallel gray measuring system.
Here e.g. 500 impulses.
2. Now declare the input of the lowest-situated bit (LSB).

In our example the position of the LSB would be at input 7. With a resolution of 500 impulses 9 bits of resolution are needed. The CamCon automatically determines the position of the remaining inputs once it knows the position of the LSB; they are determined in increasing order. In our example inputs 7 to 16 would be allocated with the bits of the rotation encoder.

- 3 Press the key to confirm your inputs and exit this menu.

8.4.1.5.3. Inkremental-measuring system

If you selected "INC" for your special measuring system in the measuring system input, the following menu is created:

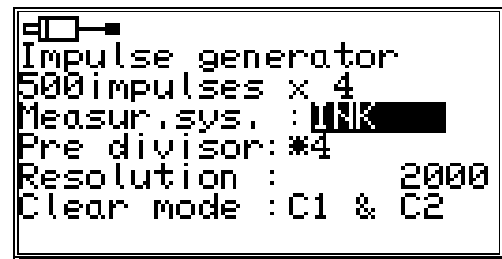

1. Enter the value of the prescaler (predivisor) with the and keys. The prescaler divides or multiplies the incoming impulses from the measuring system with the defined value. The following scalars can be entered: "*4", "*2", "*1", "/2", "/4", "/8", "/16", "/32", "/64", "/128", "/256", "/512".

Here the prescaler is set to "*4". This means that a measuring system with a resolution of 500 impulses supplies the device with 2000 impulses.

2. Now you enter in the field of the resolution the maximum number of needed impulses. This value is the maximum resolution, that can be evaluated by the CamCon. If more impulses than this maximum resolution are counted, the CamCon reports the error message "Pos Err:3". In this case the maximum resolution has to be reset with a higher value or the actual position has to be set to zero through a clear signal.

3. In the field "Clear mode" you set the functions for the two extra inputs C1 and C2 with the and the key. Here you have the choice between eight possible functions.

- "C1 & C2" If input C1 is high and C2 is high, the counter is set to zero.
- "/C1 & C2" If input C1 is low and C2 is high, the counter is set to zero.
- "C1 & /C2" If input C1 is high and C2 is low, the counter is set to zero.
- "/C1 & /C2" If input C1 is low and C2 is low, the counter is set to zero.
- "C1 : W" If input C1 is high, the counter is set to zero.
- "/C1 : W" If input C1 is low, the counter is set to zero.
- "C1 : /W" If input C1 is high, the counter is set to zero.
- "/C1 : /W" If input C1 is low, the counter is set to zero.
- "C1 : W" If input C2 is high, the impulses of the measuring system are no longer counted (Wait).
- "/C1 : W" If input C2 is high, the impulses of the measuring system are no longer counted (Wait).
- "C1 : /W" If input C2 is low, the impulses of the measuring system are no longer counted (Wait).
- "/C1 : /W" If input C2 is low, the impulses of the measuring system are no longer counted (Wait).

Attention: The "Clear mode" of the CamCon DC16 cannot be changed. Therefore is this menu point not available for the CamCon DC16. The 'Clear' signal is initiated by simultaneously supplying 24Volt signals to inputs Clear 1 (Pin 14) and Clear 2 (Pin 15).

Attention: The incremental measuring system is currently not available for the CamCon DC90.

8.4.1.5.4. Multiturn measuring system with electronic gear

If you selected "MULTI" for your special measuring system in the measuring system input, the following menu is created:

This measuring system is needed when using a multiturn encoder with a non-binary number of rotations.

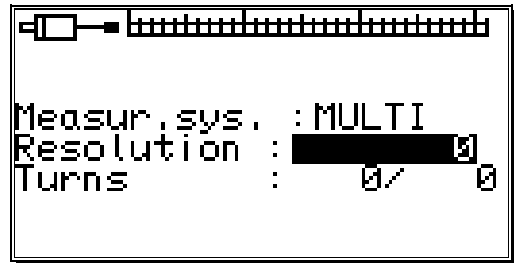

Example 1: You have a rotation plate with an electronic gear rate of 3 to 1, i.e. the encoder rotates 3 times for every rotation of the plate. These three rotations correspond with 360 impulses (360 degrees). You need to make the following inputs:

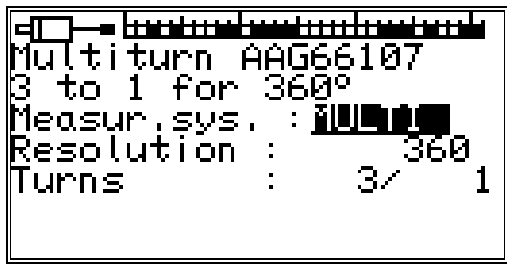

1. Enter the total resolution needed.
Here 360 impulses (360 degrees).
2. Enter the total number of rotations.
Here 3 turns.
3. Enter the divisor for uneven translation rates.
Here 1.
4. Press the CR key to confirm your inputs and leave the menu.

Example 2: You have a rotation plate with an electronic gear rate of 12.5 to 1, whereas the encoder turns 12.5 times for every rotation of the plate. These 12.5 rotations correspond with 3600 impulses (360.0 degrees). The following inputs are necessary:

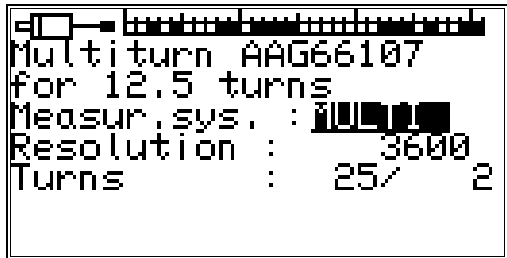

1. Enter the total resolution needed.
Here 3600 impulses (360.0 degrees).
2. Enter the total number of rotations.
Here 25 turns.
3. Enter the divisor for uneven translation rates.
Here 2.
4. Press the CR key to confirm your inputs and leave the menu.

Attention: This measuring system only functions in connection with multiturn encoders with a resolution of 4096 x 4096 impulses (Type: AAG66107 or AAG626).

Note: With this measuring system the encoder may not be moved more than 512 rotations in a cold state.

8.4.1.5.5. PLL measuring system

If you selected "PLL" for your special measuring system in the measuring system input, the following menu is created:

The PLL measuring system determines the way out of temporal interpolation of a measuring impulse. If you e.g. have installed an initiator on a rotation plate and want to determine the current position at a constant velocity without having to install another measuring system, the PLL measuring system is the right choice.

```

┌───┐
PLL measuring system
5 initiators 360°
Measur.sys. : PLL
Impulse/in.: 360/ 15
Init./c-inp: 10/ 16
Window/outp: 100/ 1
    
```

1. Enter the number of steps from initiator impulse to initiator impulse.
2. Now enter the input of the initiator impulse.
3. Now you have to enter the number of initiator impulses per total rotation.
4. Select the input for the clear impulse.
With the PLL measuring system you have the possibility to incase several initiators per total rotation. To receive a zero point you need a zero initiator that can be hooked up to the selected input. If you do not want to use a zero initiator, just enter a "0" here.
5. Then you enter the synchronous window.
If a step error is determined that is larger than the set value, the system enters the asynchronous mode.
6. Now you have to enter the output for the synchronous window that signalizes the synchronous state. If you do not want such an output, just enter a "0" in this line. This output becomes active after the PLL measuring system has been in the synchronous mode for 16 cycles.

Press the **CR** key to confirm your inputs and exit this menu.

8.4.1.5.6. Timer way simulation (time emitter)

The timer way simulation makes it possible to generate ways (or time related actual positions) time based and without the use of a measuring system. The cam switch unit then behaves similar to the control of a washing machine. For this option you have to select "TIMER" in the special measuring system menu and the following system is set up:

```

┌───┐
Timer
100 impulses in 2 sec
Measur.sys. : TIMER
Impulsetime: 0.020
Resolution : 100
Stop-input : 1
Clear-input: 2
    
```

1. First enter the time between the steps. The finest resolution of the CamCon is 5ms.
In our example we chose 20 ms.
2. Now enter the total number of steps.
We chose 100 steps for our example, so the whole process will be repeated after 2 seconds (20 ms x 100 steps = 2 seconds).
3. After this you have to enter the input for the stop signal.
This will enable the time emitter system. A high signal at this input releases the timer, and the timer is stopped by a low signal. If you do not want a stop input just enter a "0".
4. Finally you have to enter the input for the clear signal.
With this signal the time emitter system can be reset to 0. A high signal at this output causes the timer to remain at "0". If you do not want a clear input, just enter a "0" in the corresponding line.
5. Press the **CR** key to confirm your inputs and exit this menu.





8.4.1.5.7. RS232 measuring system

The RS232 way gathering is needed, if the measuring system used by you does not contain any of the interfaces described in the previous chapters.

To use this system you have to select "RS232" in the special measuring system menu and the following menu is set up:

```

RS232 way gathering
with Stegmann Pomux
Measur. sys. : RS232
Baud rate: 19200,8,n,1
Comm. prot: POMUX203BCD
Resolut. : 0
Pre divis: 0
    
```

1. First you have to enter the baud rate using the  and  keys.
2. The data transfer protocol can be set with the  key and the  key as before. At the moment only the data transfer protocol of a Stegmann Pomux 203BCD is available.
3. The resolution gives the value in which the actual position of the measuring system is moving.
4. The prescaler (predivisor) divides the resolution to enable the setting of the measuring system in devices with lower memory.
5. Press the  key to confirm your inputs and exit this menu.



Attention: This measuring system may only be used on a CamCon DC50/51, since it blocks the serial interface, making the programming via a PC or a terminal impossible!

8.4.1.6. Deleting the special measuring system

The special configuration of the measuring system can be removed as follows:





```

Meas.system
Timer
100 impulses in 2 sec
Position: 0°
Gear : 1/ 1
Format : #####°
    
```

```

?
Shall I delete the
special configuration
of measuring system ?

yes / no
    
```

1. Select the menu point "Measuring system" in the configuration menu. The following menu is displayed:
2. Select the special measuring system with the  and  keys.
3. Press the  key, and the following question is displayed:
4. Move the cursor to "yes" with the  key and confirm your choice by pressing the  key.

This deletes all settings of the special measuring system.

8.4.2. The measuring offset

If you selected the menupoint "Measuring offset" in the system setting menu, the measuring offset menu appears on the menu:

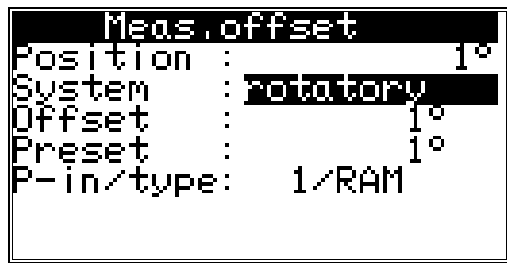

Here you can indicate, using the and keys, whether your controlling system is a rotatory (e.g. an eccentric press) or a linear (e.g. a knee lever press) moved system.

You confirm your input with the key.

8.4.2.1. Zero offset with rotatory movements

If you have chosen a rotatory movement, you can now carry out the input of the offset

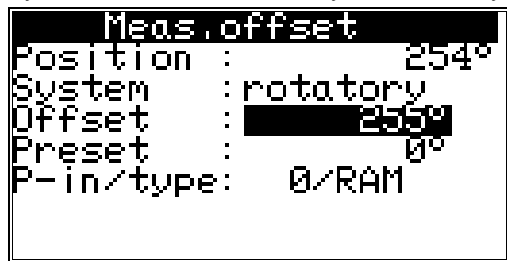

The offset is subtracted from the physical position. This makes it possible for you to shift the zero point.

8.4.2.2. Measuring offset with a linear moved system

If you have chosen a linear movement, you can now carry out the input of the moving range and the offset.

At the menu point "Start" you enter the desired begin of the proceeding range. You even have the possibility to enter negative values.

The "End" value of the measuring range changes automatically and determines the total proceeding way of the measuring system with its position. Here an input is not possible.

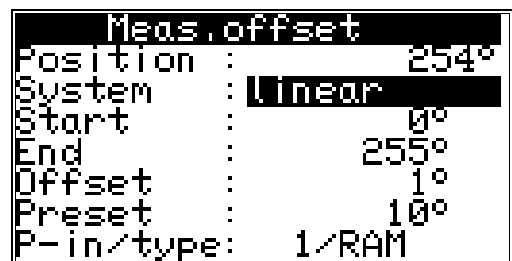

Attention: If the range between start value and end value is under- or overshoot during the way gathering of the measuring system, the CamCon switches off with the error message "Pos.Err 3".

8.4.2.3. Zero offset with linear movements

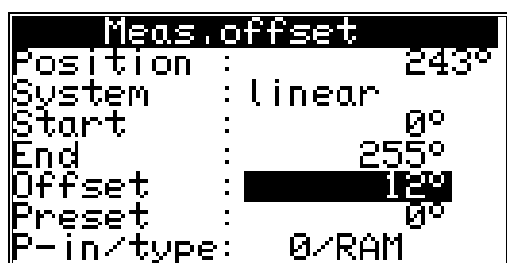

If you have chosen a linear movement, you can now carry out the input of the offset.

In the menu point "Offset" you enter the zero offset of the measuring system. The offset is subtracted from the physical position. This makes it possible for you to shift the zero point.

Note: If the rotation direction of the electronic gear is negative, the offset must be set to a value smaller than zero (e.g. -359). See chapter "8.4.1.3.1. Electronically changing the rotation direction" on page 47.

8.4.2.4. Actual position preset

In the measuring offset menu you have the possibility with the rotary system and the linear system to set the actual position to a new value by creating a new input (preset).

By setting the preset value to zero, you can generate an external zero signal, e.g. to synchronize the cycle of the machine and the actual position of the CamCon.

```

Meas.offset
Position : 243°
System   : linear
Start    : 0°
End      : 255°
Offset   : 12°
Preset   : 13°
P-in/type: 0/RAM
    
```



When you have entered the preset value, the device requests the input number of the preset signal with which the preset is supposed to be initiated. Enter the number next to the "P-In"-put line.

```

Meas.offset
Position : 243°
System   : linear
Start    : 0°
End      : 255°
Offset   : 12°
Preset   : 13°
P-in/type: 5/RAM
    
```

```

Meas.offset
Position : 243°
System   : linear
Start    : 0°
End      : 255°
Offset   : 12°
Preset   : 13°
P-in/type: 5/EEPROM
    
```

Afterwards select, using the keys  and  in the input field "type", the mode of storage of the preset value. Here you have two possibilities:

- "RAM" storage.

Here the preset value is copied into the RAM memory of the device. This means that after switching the device off and on again, the shifting of the actual position equals the zero offset or the offset is no longer available.

- "EEPROM" storage.

Here the shifting of the actual position is copied into the RAM and into the EEPROM memory of the device, making it safe to shut off the device without losing your data.

Attention: *You should only store your data in the EEPROM memory, if the triggering of the preset just occurs rarely and is absolutely required. This is because of the fact that an EEPROM only has a limited number of writing cycles: 100000). Shooting over this maximum number of writing cycles leads to the destruction of the EEPROM and the loss of the program data of the CamCon.*

8.4.3. The speed adjustment

If you selected the menu "Speed" in the system setting menu, the speed adjustment menu appears on the display:

You can use it to optimally adjust the speed of the device to the speed of the gear.

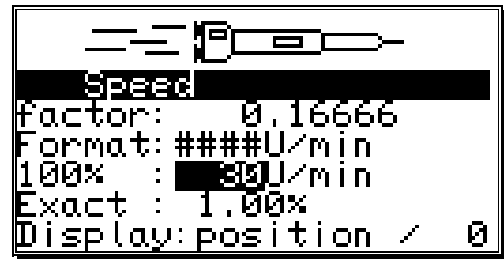

8.4.3.1. The speed factor

Normally the speed is displayed through the number of increments or impulses per second, an output of the measuring system. If you want the speed displayed e.g. in rotations per minute or in the number of pieces per minute, you have to enter a randomizing factor.

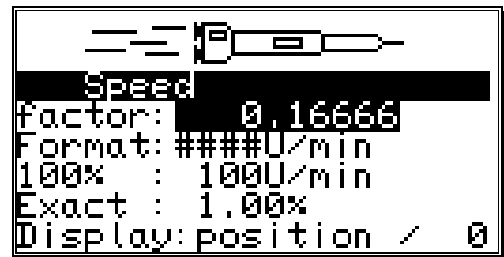

Example 1: A rotation encoder with 512 steps supplies 512 increments per minute, which means that the gear runs with 1 rotation per minute. The CamCon measures $512/60 = 8,533$ increments per second. To receive a display in rotations per minute enter the factor $1/8,533 = 0,1172$.

Example 2: A rotation encoder with 360 steps supplies 360 increments per minute, which means that the gear runs with 1 rotation per minute. The CamCon measures $360/60 = 6$ increments per second. Enter a factor of $1/6 = 0,16666$ to have the display remain in rotations per second.

8.4.3.2. The display format of the speed display

When you have adjusted the speed range with the factor, you can enter the presentation format of the display, using the and keys (see chapter "6.4. Text input" on page 29).

The # symbols are place holders for the displayed value. If e.g. the highest value is lower than 1000 and only has three digits, you only enter three # symbols. If you want a decimal point displayed, just insert it between the symbols (e.g. : ###.##). Press the key, and the cursor moves to the next menu point.



8.4.3.3. Range adjustment of the speed display

In this menu point you enter the maximum speed of your gear or the speed of your movement. This input is used to adjust the speed display.

An input of e.g. 1000 rotations per minute means that at +/-1000 rotations per minute the maximum analog output voltage, (100%) +/-10V, is reached.

This scale also applies to the speed bar that is shown in the middle of the standard display. Its length is the current speed compared to the entered reference speed in percent. Furthermore this is the point of the speed where the standard display switches from the position to the current speed. This point always lies at 5% of the here

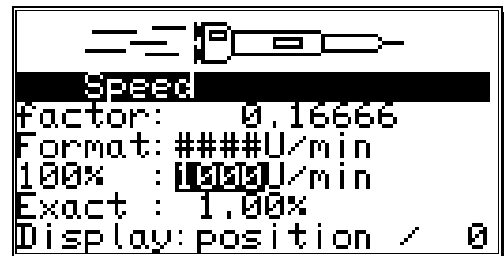

entered value, for 1000 rotations per minute it lies at 50 rotations per minute. Press the key or the key to move the cursor to the next menu point "Exact".

8.4.3.4. Accuracy of the speed display

During operations the speed display usually fluctuates by a certain value. These fluctuations are accounted for in the measuring principle for the speed, since it is a scanning system.

In the menu point "Exact" you can limit these fluctuations to a maximum value. It is a damping through a low pass that results in a smoothing of the display, which means that an averaging process is put into operation. The lower the input value is, the quieter is the speed display. In practice, you will always find a compromise between the dynamics of the display and its readability.

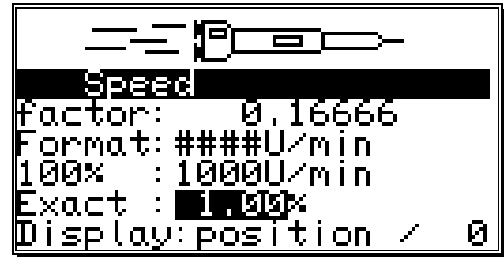

Press the key to move the cursor to the next menu point.

8.4.3.5. Display, Type

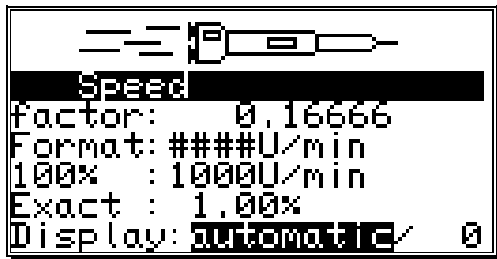

If you want to prevent the automatic switching at the 5% of the maximum speed in the "Display" menu point, you can select one of the three different display types with the key and the key.

- "Automatic" At the 5% point the display is switched from the position display to the speed display. This bar display shows the speed in percent.
- "Speed" Only the speed is shown on the display. The bar display shows the speed in percent.
- "Position" Only the position is shown on the display. The bar display does not show the speed, but it displays the position between 0% and 100% e.g. 0% = 0 Degree / 50% = 180 Degrees / 99% = 359 Degrees.

In addition to the three display types, you can also select the desired display type through an input. The display type has to be set to either "Speed" or "Position", and the number of the input has to be entered in the field behind. When input is passive, the set display type is displayed. When you supply a signal, the display changes from "speed" to position or from "position" to "speed".

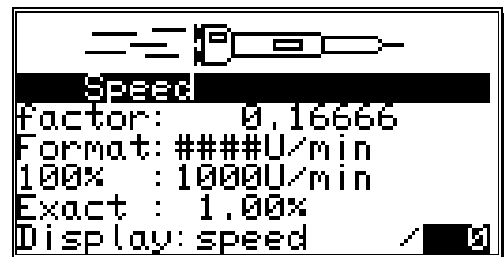

Press the key to confirm your inputs and exit this menu.

8.4.4. Cable length / Cycle time

If you selected the menu "Cable length/Cycle time" in the system setting menu, the following menu is set up on the display:

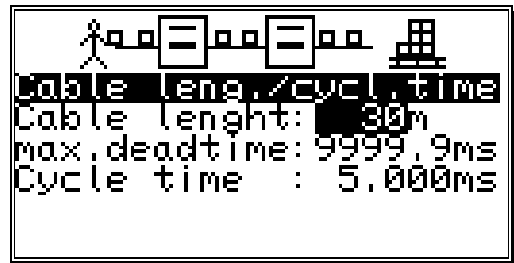

8.4.4.1. The cable length

In this menu point you can set the conduction length between the SSI measuring system and the CamCon, as well as between external input or output extensions and the CamCon, in meters. This is necessary, since the cable length determines the maximum possible speed of serial data transmission. The larger the set cable length, the larger is the cycle time of the transmission and the slower is the data traffic. The cable length can be set to a maximum of 1000m.

Attention!! With cables exceeding 300m in length use a corresponding measuring system as well as extensions with a changed mono-flop-time.

8.4.4.2. The cycle time of the CamCon

Normally the CamCon operates with the shortest possible cycle time. It is displayed as long as the cursor is not on the menu field "Cycle time". With an input in the menu field "Cycle time" this time value can be changed.

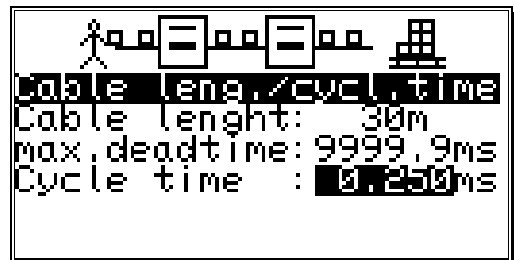

This might become necessary, if e.g.:

- you are programming a large number of outputs with dead time or with a high measuring system resolution and need longer single dead times. These depend on the available memory and the cycle time (see chapter "13. Calculation of the RAM memory" on page 79). A noticeable change occurs only when the set value lies above the current cycle time. For this reason the display also shows the maximum possible dead time compensation.
- you connect a measuring system that allows the readout of the data only once in a given time.

Press the **CR** key to end your input and exit the menu.

8.4.5. The special outputs

If you selected "Special outputs" in the system setting menu, the special outputs menu appears on the display:

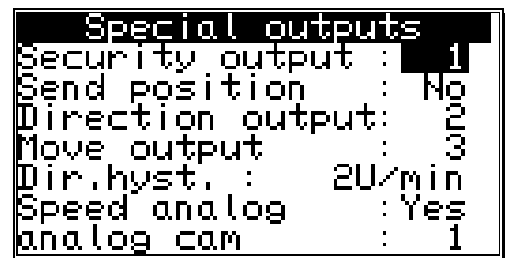

8.4.5.1. The security output

To have the possibility to supervise the CamCon e.g. after short circuits on the output channels or mistakes in the measuring system, you can program a circulation cam for a single output, so that this output is switched off at the occurrence of a mistake and serves as a security output. With a program change, the security output is reset for a short time (see chapter "8.4.6.6. Setting the program selection mode" on page 62).



A "0" in the input field defines that no security output has been programmed..

8.4.5.2. The output of the actual position

The CamCon offers the possibility to put the physical actual position out to outputs. It is used when several CamCon need the same actual position (Master Slave connection). To be able to use this option, the number of the programmed outputs has to be lower than the number of the actually available ones (see chapter "8.4.6.2. Setting the outputs" on page 61. The output of the bit with the lowest value will occur after the last programmed output. The other bits follow in increasing order.

```

Special outputs
Security output : 1
Send position   : Gray
Direction output: 2
Move output     : 3
Dir.hyst.      : 2U/min
Speed analog    : Yes
analog cam     : 1
    
```

With the  and  keys you can choose 4 possible output formats:

- "No" = No output of the actual position.
- "Gray" = Output of the actual position in the gray code.
- "Bin." = Output of the actual position in the binary code.
- "Exp." = Output of the actual position in the gray code only for CamCon DC115.

Confirm your input with the  key.

8.4.5.3. Direction output

To be able to recognize the direction of the movement of a machine with different movement directions, you can program an output that switches on at a positive and off at a negative movement.

```

Special outputs
Security output : 1
Send position   : Gray
Direction output: 2
Move output     : 3
Dir.hyst.      : 2U/min
Speed analog    : Yes
analog cam     : 1
    
```

8.4.5.4. The standstill output

The CamCon offers the possibility of a standstill surveillance. Here you can define an output that is switched on when the actual speed is greater than the at "dir Hyst." entered value and that switches off when the speed drops below that value again.

```

Special outputs
Security output : 1
Send position   : Gray
Direction output: 2
Move output     : 3
Dir.hyst.      : 2U/min
Speed analog    : Yes
analog cam     : 1
    
```

8.4.5.5. The hysteresis

To be able to use the options of movement direction surveillance and standstill surveillance correctly, you have to set the hysteresis. This value is needed to suppress the jittering of the outputs at small changes in speed. This value can only be determined through experiments, but it should be as small as possible.

```

Special outputs
Security output : 1
Send position   : Gray
Direction output: 2
Move output     : 3
Dir.hyst.      : 2U/min
Speed analog    : Yes
analog cam     : 1
    
```



8.4.5.6. The analog speed output

```

Special outputs
Security output : 1
Send position   : Gray
Direction output: 2
Move output     : 3
Dir.hyst.      : 2U/min
Speed analog    : yes
analog cam     : 1
    
```

CamCon emits a voltage (proportional to the speed) on the first analog output (pin 2 at CamCon DC50), 0 to -10V with a negative rotation direction and 0 to +10V with a positive rotation direction, if the menu point "**Speed Analog**" is set to "**yes**".

The output voltage reaches its maximum of 10V, when the 100% value, described in chapter "8.4.3. The speed adjustment", is surpassed.

You can deactivate this function by setting the menu point to "**no**" with keys  and , and confirming it with the  key.

Note: At the time, there are no integrated analog outputs available for CamCon DC16 and DC90. You can add analog outputs by connecting a CamCon DAC16 digital - analog - converter module to the external interface of the CamCon.

Note: To clear the integrated analog outputs please see chapter "8.5.3.3.1. Clearing the integrated analog outputs" on page 69.

8.4.5.7. Configuration of the analog cams



```

Special outputs
Security output : 1
Send position   : Gray
Direction output: 2
Move output     : 3
Dir.hyst.      : 2U/min
Speed analog    : Yes
analog cam     : 2
    
```

With a CamCon cam controller you have the possibility to make an output of free programmable analog values (cams) dependent on the position. You enter the number of analog outputs in the menu point "**Analog cams**", that you want to program via the CamCon. In most cases, this will also be the number of your analog hardware outputs.

Note: If the menu point "**Speed Analog**" is set to "**yes**", the first analog output is used to display the speed, and the number of possible analog outputs is decreased by one.

When you enter the number and press the  key, you enter the input of the specific settings for the analog cams:

First you choose the number of the analog output with keys  and .

Press the  key to confirm the number and change the display to the input of the display format.

```

analog outputs
Nr.      : 1
Format   : ####.##%
Minimum  : -100.00%
Maximum  : 100.00%
Dis.Input : 0
Dis.Wert : -100.00%
Interpol. : Yes
    
```

```

analog outputs
Nr.      : 1
Format   : ####.##%
Minimum  : -100.00%
Maximum  : 100.00%
Dis.Input : 0
Dis.Wert : -100.00%
Interpol. : Yes
    
```

Here you enter your desired format, as described in chapter "6.4. Text input" on page 29. It is e.g. possible to make the input in percent "####.##%" (standard), in voltage "###.###V", in bar "#.###mbar" or in Ampere "##.###mA". The double-crosses are just placeholders for the real numerical values. The scaling of the input values is done in menu points "**Minimum**" and "**Maximum**".

```

analog outputs
Nr. : 1
Format : ##.###mA
Minimum : 4.0000mA
Maximum : 20.0000mA
Dis.Input : 0
Dis.Wert : 4.0000mA
Interpol. : Yes
    
```

When you confirm the format with the **CR**, you enter the input for the minimum value.

Note that CamCon always calculates with an accuracy of 16 Bit. The minimum value is the bit value 0 (e.g. -10V or 4mA) and the maximum value is the bit value 65535 (e.g.+10V or 20mA). The values should be entered according to the purpose of the device. If e.g. an CamCon DAC16/I module (current output) is connected to the

external display, the input can be made in milliampere, or the milliampere value corresponds to a physical pressure - or speed, this value can also be entered in bar or meters per second (see values in figure above).

Note: The integrated analog outputs of the CamCon DC40, 50 and 115 all work with an accuracy of 8 Bit. The output of the analog cam values is recalculated from 16 bit to 8 bit in this case.

After the minimum and maximum values have been confirmed with the **CR** key, the com inputs in the programming menu are restricted to the range between minimum and maximum and recalculated, if necessary.

The output of the analog value can be stopped by setting an input to a specific value. For this purpose enter the input number in the menu point "**Dis.inp.**" (Disable Input), with which the analog value is set to the "**Dis.val.**" (Disable Value). The "Dis.value" must be within the range of minimum and maximum. The "Dis.val." is automatically set as a default value, if no cam has been programmed on the analog output.

When the "Dis.val." is confirmed you can activate ("yes") or deactivate ("no") the interpolation of the analog value with the keys **◀** and **▶** in the menu point "**Interpol.**". If this value is set to "yes", CamCon interpolates the programmed values from definition point to definition point.

Example:

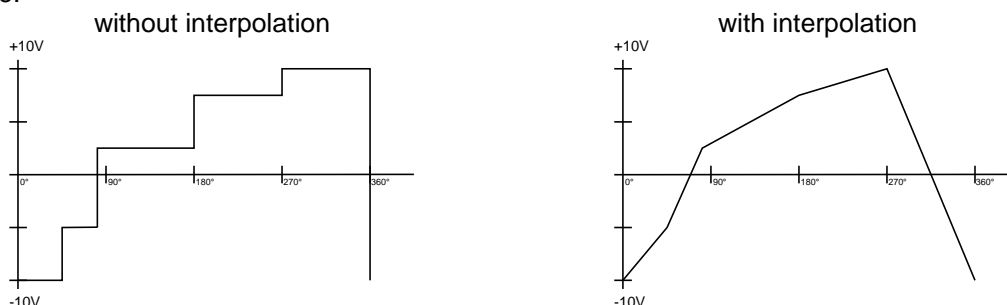

By pressing the **CR** key, the input of the interpolation is confirmed, and you move back to the selection of the number of the analog output. Here you can choose the number of the next analog output with the keys **◀** and **▶** and proceed with the input of the values as before.

When the input is finished, you can leave the menu by pressing the **ESC** key.

For the input of the cam values please see chapter "8.3.16. Programming analog cams" on page 44.

8.4.5.8. The analog position output

The analog position output of the CamCon can be programmed with a software version of at least DC50.20, by the input of an analog cam. Herefore you program an analog cam, that emits -10V at an actual position of 0 degrees and +10V at an actual position of 359 degrees (see chapter "8.3.16. Programming analog cams" on page 44).

8.4.6. System upgrading

If you selected the menupoint "**System upgrading**", the following menu appears on the display:

```
System upgr.  
Inp.: 32   Outp: 56  
dtc outputs: 40  
k-lock-inp.: 8  
ext.prg.max: 16384  
ext.prg.in : 16  
prg. select: on pos.  
change at : 20°
```

8.4.6.1. Setting the inputs

Here you can enter the number of inputs available to the CamCon. This number of inputs should always be exactly the same as the number of electrical inputs, since the short circuit detection of the CamCon reacts to the number of inputs.

8.4.6.2. Setting the outputs

Here you can enter the number of outputs available to the CamCon. This number of outputs should not be greater than the number of electrical outputs, since this only results in a waste of memory and cycle time. If you want to make an output of the actual position at the outputs, you have to decrease the number of outputs by the corresponding number of bits (see chapter "8.4.5.2. The output of the actual position" on page 58).

8.4.6.3. Setting the outputs with dead time compensation

Here you can enter the number of outputs with dead time compensation available for the CamCon. The number of outputs should not be greater than the maximum number of the absolute necessary outputs; otherwise only memory and cycle time are wasted.



8.4.6.4. Setting the keyboard lock

Assigning a +24VDC level to the programmed input pin will disable the keyboard. After this it is not possible to program or initialize the device any more. Resetting the value to "0" will enable the keyboard again.

8.4.6.5. Setting the external program selection

With the CamCon you have the possibility to externally select the desired program number through the inputs. Here you enter the number of programs that can be selected externally, and this simultaneously predefines how many inputs will be used for this purpose. Then the input for the take over impulse is stated. The program number is created as a binary number at the inputs after the take over impulse. The bit with the lowest value is the input after the take over impulse, all others then follow it in an increasing order. Because of this the inputs for program selection are completely relocatable.. With an impulse (+24V) the program is selected at the input of the take over impulse. This impulse has to be created at least 20 ms after the program number and has to be at least 20 ms long.

8.4.6.6. Setting the program selection mode

You can change programs in several ways. Here you have the possibility to determine the desired way to change the programs with keys  and . You can select between:

"slow" Here the selected program is built up cam after cam. This type of program changing requires the least memory, but a complete change of programs during a full run can lead to complication with the machine. In this case the security output of the CamCon is switched off for a short time.

"direct" Here the selected program is built up cam after cam in an intermediate memory and changes the full program at once. This type of program changing requires the double amount of memory for the cam build up, but the outputs are always defined in every cycle. The security output of the CamCon will not be switched off in this case.

"on position" The program is built up in the same way as in the "direct" type, but here the CamCon waits with the program change until the machine has passed a certain position and then makes a complete program change. This type of program changing also requires the double amount of memory for the cam build up, but the outputs are always defined in every cycle. The security output of the CamCon will not be switched off in this case.

Note: With the DC115, you can select a different program selection mode for each program.

8.5. Unit configuration

At the first activation of the CamCon, you should initiate a complete deletion and, if desired, allocate the user keys for associates. To do this, select the main menu point "**Unit configuration**". The display changes to display the configuration menu:

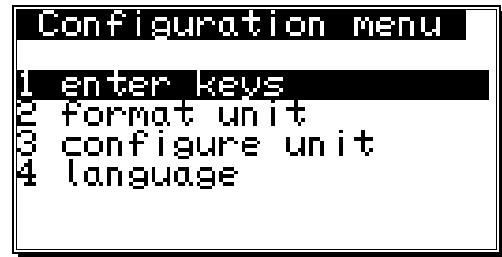

8.5.1. User key allocation

You can assign different user keys to your associates, each with different access rights.



Attention: As long as no key is created, you can enter every menu with the key code "5693". When you create your first key, this master key is automatically deleted. If you forget to create at least **one** key that allows access to the configuration menu, you have locked yourself out of the configuration menu as soon as you leave it. This can be overcome by sending the unit back to Digitronic or with the entry of a special supervisor number. You can acquire this number with a phonecall to Digitronic Automationsanlagen.







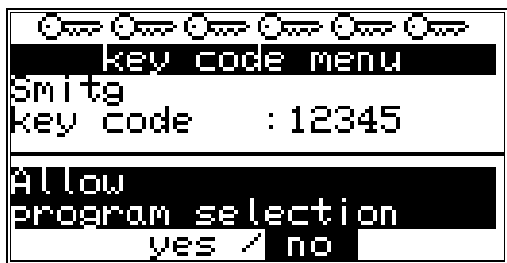
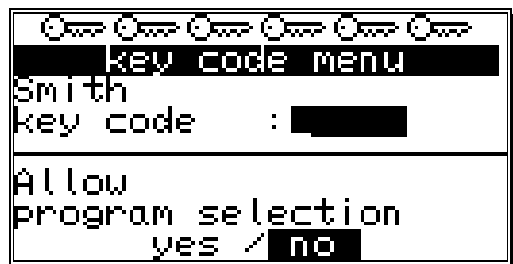
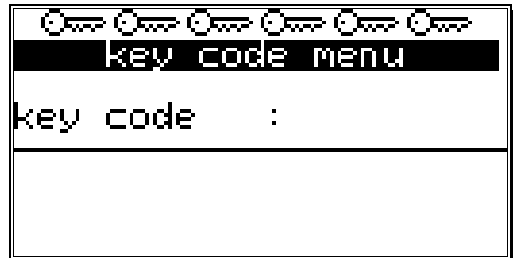





8.5.1.1. Creating a new user key



Follow these steps to create a new user key:

1. Select the menu point "**Key allocation**" in the configuration menu; the display changes to the key allocation menu:
2. Press the **INS** key, and the input field for the name is underlined in black.
3. Enter a name. See chapter "6.4. Text input" on page 29.
4. End the text input with the **CR** key, and the cursor moves to the input field "**Key number**".
5. Enter the key code with the numeric keys (up to 5 numbers).
6. Press the **CR** key. The cursor moves to the input field for the **access to the program selection**.





7. Choose between "**yes**" and "**no**" with keys **◀** and **▶**.
8. Press the **CR** key. The cursor moves to the input field for the **access to the cam programming**.
9. Choose between "**yes**" and "**no**" with keys **◀** and **▶**.
10. Press the **CR** key. The cursor moves to the input field for the **access to the system menu**.

11. Choose between "yes" and "no" with keys  and .
12. Press the  key. The cursor moves to the input field for the **access to the configuration menu**.
13. Choose between "yes" and "no" with keys  and .
14. Press the  key. The cursor moves to the input field for the **access to the outputs, generally and for every output**.
15. Choose between "yes" and "no" with keys  and .
16. Press the  key. If you chose "no" in the previous input field, you can now assign the access to each output one by one.
The cursor moves to the input field for the **access to output No. 1**.
17. Choose between "yes" and "no" with keys  and .
18. Press the  key. The cursor moves to the input field for the **access to output No. 2** and so on...
19. You can leave this menu at any time by using the  key.



Note: You can also select the menu fields for the single access rights with keys  and .

8.5.1.2. Deletion of a user key

You can delete a user key according to the following procedure:

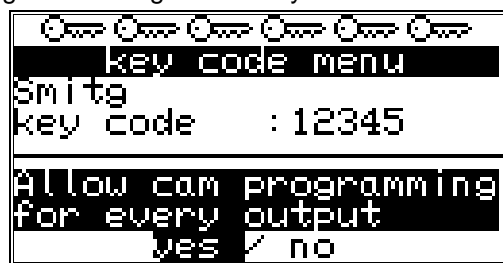
1. Select the menu point "Key allocation" in the configuration menu; the menu for the key allocation appears:
2. Select the user key you want to delete with keys  and .
3. Press the  key; the display shows the question:







3. Move the cursor to "yes" with the  key.
4. Press the  key, and the key is deleted.

Additionally: If you happen to delete every key in this menu, the standard key code "5693" is automatically generated.

8.5.1.3. Checking the key configuration

You can check an allocated key the following way:

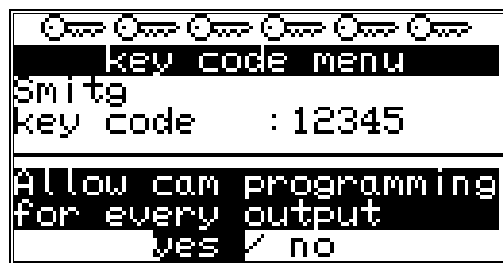

1. Choose the menu point "Key allocation" in the configuration menu; the menu for the key allocation appears:
2. Select the key that is to be checked with keys  and .
3. Now you can check the single access rights mit keys  and .

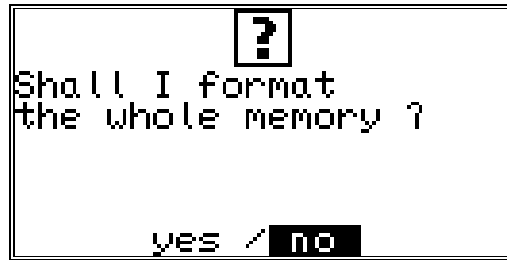

8.5.2. Complete deletion

If you selected the menu point "**Complete deletion**" in the "**Unit configuration**" menu, the display shows :



You can move the cursor to "**yes**" with the  key and confirm it with .

After a short while the display returns to the main menu. This time depends on the size of the EEPROM used, since the memory has to be formatted. Using e.g. a 32k EEPROM the process takes about 2 minutes. Afterwards, the complete deletion is complete. All cams are deleted, and the system registers have their standard values.

Now you can begin with the programming.





Attention: Deleted information cannot be restored.

8.5.3. Unit configuration

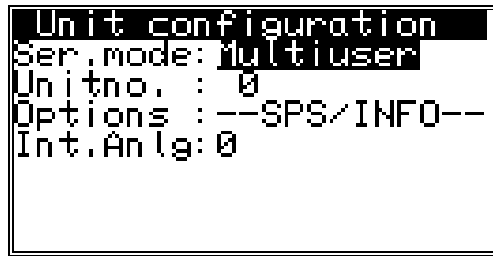
If you selected the menu point "Configure unit" in the "Unit configuration" menu, configuration menu appears on the display:



8.5.3.1. Setting the serial interface

You can select the mode of the serial interface with keys  and  in the input field "Ser.mode", confirming your selection with the  key afterwards. There are four different types of operation available: 1. = "Cam-BUS", 2. = "Standard", 3. = "Multiuser" and 4. = "S5-L1". When you select a specific communication mode, you have to make sure that every connected device you want to make contact with supports this communication mode. Please note also that you can specify the type of serial interface with your order of the CamCon. You can choose between an RS232 or an RS485 interface. All four "Ser.Modes" operate with the RS232 point to point communication as well as with the RS485 BUS communication. See also chapter "5.1.6.2. Pin allocation of the serial RS485 interface" on page 20 and chapter "8.5.3.1.5. Input of the unit number" on page 67.

Note: As a standard, the device comes with Ser.Mode set to "Multiuser" and the unit number set to "0".

8.5.3.1.1. The "Cam-BUS" communication mode

Select this mode, if you want to be able to program or display CamCon cam controllers from different places, e.g. you want the CamCon, the daughter display CD10 and the PC via the RS485 BUS.

Attention: Using the configuration above or similar requires that **all** CamCon devices, as well as any connected PC be equipped with an RS486 serial interface and a software of at least December 1996.

8.5.3.1.2. The "Standard" communication mode

The standard mode operates with point to point communication, i.e. you can only connect 2 devices, e.g. a CamCon to a PC or a CamCon to a CamCon DC50/51 Terminal. Since this communication mode does not use any protocol security, its usage is only allowed for testing purposes.

8.5.3.1.3. The "Multiuser" communication mode

Contrary to the "Cam-BUS" mode, it is "not" possible to operate several devices, e.g. CamCon Terminal DC51/T4, the daughter display CD10 and the PC, on the RS485 BUS. (**PRESET**)

8.5.3.1.4. The "S5 - L1" communication mode

This setting is necessary, if you want to program the CamCon device via a Siemens S5 CPU. The process is a point to point communication, i.e. you can only connect the CamCon and the Siemens S5 CPU. If you want to store the data of your CamCon on a PC, you have to break your connection to the S5 CPU. For the S5 - L1 communication mode, you can order a connection set composed of: a TTY cable, function segments and a handbook (Ordering.No.: PCXX/S5-L1 XX=CamCon Type).

8.5.3.1.5. Input of the unit number

In the Multiuser and in the Cam-BUS operation, you need to set a unit number for every device on the BUS. This number can be set under the menu point "UnitNo:" and is then displayed in the main menu in the highest line on the display. You may only allocate each unit number once for a single linked RS485 BUS operation. Because of this, you need to set the "UnitNo" and the "Multiuser" or "Cam-BUS" mode for every device separately, before connecting the serial interfaces.

8.5.3.1.6. Programming via remote

If you want to program the CamCon from a separat control, you can order a handbook with a description of the programming sequences (Ordering.no.: H-DC50/PROTO).

8.5.3.2. Additional device options

At the time, the CamCon has the options "PLC" and "PLC/INFO" available. If want your CamCon to be equipped with one of these options, please specify with your order : ("PLC" = S) ("PLC/INFO" = M). These options are described in an extra handbook (H-PLC), which is not in the supply package of the CamCon.

8.5.3.2.1. PLC Logic Module

The firm Digitronic Automationsanlagen GmbH is an accomplished and well-known supplier and developer of electronic cam controllers for the industry. The experiences of connecting PLC controls and cam controllers, collected in years of close cooperation with the users, have been regarded during the creation of the PLC Logic Module. The result is a PLC software for the CamCon, that works parallel to the cam controller. The in- and outputs of the cam controller are linked without external logics or hardware, e.g. Timers (Way - Time - Cams), Set - Reset - Functions, and registers and can so be operated within the cycle time of the cam controller. This combination guarantees the best possibility of using the advantages of the CamCon dead time compensation and the logic of the PLC, without the loss of switching speed because of slow external switching elements (e.g. relays, timers and central PLC controls with high cycle time).

8.5.3.2.1.1. Examples for using the PLC logic module

Example 1: Output deactivation.



Output 1 of the CamCon is cleared if inputs 1 and 8 are active.

Example 2: Output depending on the rotation direction.



Output 1 of the CamCon is enabled when the rotation direction output 32 is **active**.

This is the case when the direction of the rotation is **positive**.

Output 1 of the CamCon is enabled when the rotation direction output 32 is **not active**.

This is the case when the direction of the rotation is **negative**.

Example 3: Flank assessment.



Register 2 is activated for one cycle when the signal at input 1 changes from 0 to 1.

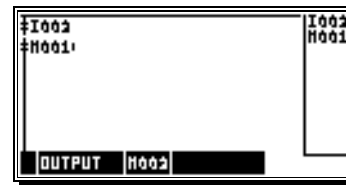

Register 2 is activated for one cycle when the signal at input 2 changes from 0 to 1.

8.5.3.2.2. PLC Logic Module with text display

Available with the PLC Logic Module is a text display you can use to show and describe the different states of your machine.

Example:

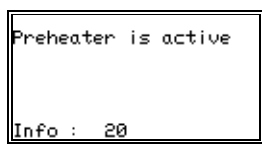

8.5.3.3. Analog outputs

The electronic cam controllers of the CamCon series are equipped with analog outputs (CamCon DC40/50/51 optionally, CamCon DC115 as a standard), via which speed, position or the cam values can be emitted as analog signals.

Note: With units CamCon DC16 and DC90 you can only use the analog outputs by connecting a CamCon DAC16 digital - analog - converter to the external interface.

8.5.3.3.1. Clearing the integrated analog outputs

At the time, units CamCon DC40/50/51 (optionally) and CamCon DC115 (as a standard) are supplied with integrated analog outputs. The outputs are cleared by setting their number in the menu point "Int.Anlg". The possible numbers are 0,1 and 2. A value of 0 deactivates the integrated outputs.

Note: Not possible with CamCon DC16 and DC90.

If the value is greater than 0, a line for adjustments appears below the menu point "Int.Anlg".

```
Unit configuration
Ser.mode: Multiuser
Unitno. : 0
Options : --SPS/INFO--
Int.Anlg: 0
```

8.5.3.3.2. Adjusting the integrated analog outputs







The integrated analog outputs of the CamCon have to be regulated from time to time and after the first activation. Offset and amplification can be adjusted. The maximum analog output voltage is $\pm 10V$ with a resolution of 8Bit. Should you wish for a smaller voltage range, you can edit the maximum voltage via the amplification factor.

Offset output 1

```
Unit configuration
Ser.mode: Multiuser
Unitno. : 1
Options : --SPS/INFO--
Int.Anlg: 2
Analog 1=> 0.000V ←→
```

Amplification factor output 1

```
Unit configuration
Ser.mode: Multiuser
Unitno. : 1
Options : --SPS/INFO--
Int.Anlg: 2
Analog 1=> 10.000V ←→
```

With keys  and  you can set the amplification and the offset through repeated adjustments with the keys and measuring the analog output voltage. From analog output 1 to analog output 2 and to switch between offset and amplification factor, press keys ,  or . When all 4 adjustments are made, the input is ended with the  key and the menu is left.

See also chapters "8.4.5.6. The analog speed output" on page 59, chapter "8.3.16. Programming analog cams" on page 44 and chapter "8.4.5.7. Configuration of the analog cams" on page 59.

Note: An adjustment of the speed display via the amplification factor is not recommendable.





8.5.3.3.3. External analog outputs

Additional external analog outputs can be connected to a CamCon through a CamCon DAC16 digital - analog - converter module at the external interface.

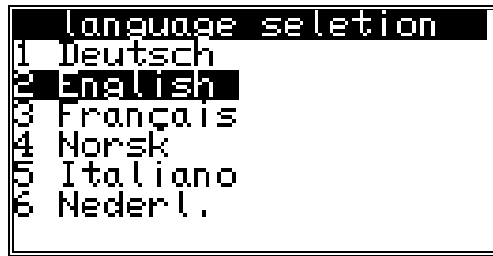
8.5.4. Language

If you selected the menu point "Language" in the "Configuration" menu, the menu for the language setting appears:





Here you can move the dark field to the desired language using the keys , ,  and . You adapt the selected language by pressing the  key.

8.5.5. User text

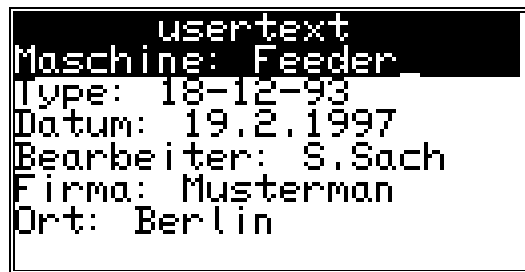
If you selected the menu point "User text" in the "Configuration menu", the following menu appears on the display. Here you can enter general information about e.g. your machine for the CamCon to display. There are 7 lines available, with 21 characters each.



For the input of the text please see the chapter "6.4. Text input" on page 29. You can store the text and move on to the next page by pressing the  key. You can exit this menu at any time with the  key.

9. Device info

If you want to get an overview of whole configuration of the CamCon, you should select the information menu of the unit configuration. Select the main menu point "**Unit configuration**", and press the **ESC** key during the input of the user code (the input of the user key is not required here) or you press the **#** key in the "**configuration menu**". The first page of the information menu appears on the display. With the help of the arrow keys or the **CR** key you can view the other pages. You can exit this menu at all times by pressing the **ESC** key.

```

user text
Maschine: Feeder
Type: 18-12-93
Datum: 19.2.1997
Bearbeiter: S.Sach
Firma: Musterman
Ort: Berlin
    
```

- User text inputs

```

Info: memory
EPROM: 19.12.1996
Cam      : 2603/ 71
Dead time : 4722.9 ms
Resolution : 8192
RAM size  : 131072
Ser. EEPROM: 0
Par. EEPROM: 32768
    
```

- Software version
- Number of free cams / number of programmed cams
- Maximum dead time setting
- Maximum setting for the physical resolution of the measuring system
- Size of the RAM in bytes
- Size of the serial EEPROM in byte
- Size of the parallel EEPROM in byte

```

Info: measuring sys.
SSI Singleturn
360 Gray
Measur.sys. : SSI
hyst.       : 0
Gear        : 1/ 1
Format      : #####°
    
```

- Configured measuring system
- Actual position hysteresis
- Rotation direction and gear factor
- Display format of the actual position

```

Info: measuring sys.
SSI Singleturn
360 Gray
Measur.sys. : SSI
Res./offset : 9/ 9
gray offset : 76
SSI-errorbit: 14
    
```

- detailed configuration of the measuring system

```

Info: measuring offset
System      : linear
Start       : 1°
Offset      : 2°
End         : 360°
Preset      : 3°
P-inp/typ: 5/EEPROM
    
```

- Configured moving system
- Activation point of the linear moved system
- Offset (shifting of the zero point)
- Value of the actual position preset
- Input number of the actual position preset / Memory of the actual position preset

```
Info: speed
factor: 0,16666
Format:####U/min
100% : 1000U/min
Exact : 1,00%
Display: position / 0
```

- Factor of the speed display
- Display format of the speed display
- 100% value for the speed display
- Accuracy of the speed display
- Display menu of the display type / Input for the display change.

```
INFO: Cable l./cycle
Cable lenght: 30m
target time : 0,000ms
Cycle time : 0,288ms
```

- Cable length of the measuring system and the external upgrade
- Set planned value of the cycle time
- Cycle time need by CamCon
- Temperature in the encasement of CamCon (only at CamCons DC40/50/51)

```
Info: Special outputs
Security output : 1
Send position : No
Direction output: 2
Move output : 3
Dir.hyst. : 2U/min
Speed analog : No
analog cam : 0
```

- Output number of the security output
- Format of the displayed actual value
- Output number of the F / R output
- Output number of the stand still output
- Hysteresis for the recognition of the stand still speed
- Analog speed output "yes/no"
- Number of analog cam outputs

```
Info: system upgrad.
Inp.: 16 Outp: 32
dte outputs: 16
k-lock-inp.: 1
ext.prg.max: 128
ext.prg.in : 1
prg. select: on pos.
change at : 51°
```

- Number of inputs
- Number of outputs
- Number of outputs w. dead time compensation
- Input number for the electronic programming lock
- Number of externally selectable programs
- Input number of the first input for the external program selection
- Change mode of the program selection

```
Info: PLC
PLC-module: off
Phys.input: 16
Phys.outp.: 32
Register : 8
Timer/Cnt.: 8
virt. inp.: 8
spec. inp.: 8
```

- PLC logic module configuration

```
Info: Options
Ser.mode: Multiuser
Unitno. : 0
Options : --SPS/INFO--
Int.Anlg: 0
CPU-Clk.: 25,2Mhz
PLC-boost: on
```

- Mode of the serial interface
- Unit number
- additional options of the e.g. PLC option or PLC option with text display
- Number of internal analog outputs
- CPU - Speed (clock) 16 or 25 Mhz
- Hardware PLC - acceleration (on/off)

```
Info: Analog outputs
Nr.      : 1
Format   : ####.##%
Minimum  : -100.00%
Maximum  : 100.00%
Dis.Input : 0
Dis.Wert : -100.00%
Interpol. : Yes
```

- Configuration of the analog cam 1,2, up to 13.
- Input and display format
- Minimal input value (- 10V)
- Maximum input value (+ 10V)
- Input number for switch to dis.value
- Output value if switch off
- Interpolation yes/no

For each of the analog cam the CamCon displays one more information menu. A maximum of 13 analog cam are possible.

10. Error messages and error recovery

The error messages appear on the standard display or on the status LEDs, on CamCon units without LCD displays (e.g. CamCon DC16/90 and DC115).

The drawing below shows the error message appearing for 'Position - Error 3'.



The display for other errors is almost the same.

10.1. Problem: Display shows "No contact to unit: XX".

Possible causes:

The wiring is probably not correct, no device with the selected unit number is on the BUS or the setting of the 'Ser.Mode' is wrong.

Solution:

Check the wiring and the configuration of the serial interface.

See chapter "5.1.6.2. Pin allocation of the serial RS485 interface" on page 20 and chapter "8.5.3. Unit configuration" on page 66.

10.2. Problem: Display shows "Pos - Err:1".

Possible causes:

The measuring system is not connected correctly.

Solution:

Check the wiring to the measuring system. Consult the handbook of your measuring system.

When the error is corrected you can clear the error message by pressing the  key.

10.3. Problem: Display shows "Pos - Err:2".

Possible causes:

The measuring system is connected wrong or not at all.

The setting of the error bit in the special measuring system configuration is not correct.

Solution:

Check the wiring to the measuring system.

Check the resolution of the measuring system.

Consult the handbook of your measuring system.

When the error is corrected you can clear the error message by pressing the  key.

10.4. Problem: Display shows "Pos - Err:3".

Possible causes:

The resolution of the measuring system does not match with the resolution of the CamCon. The actual position has left the range for linear systems set in the way adjustment menu. See chapter "8.4.2.2. Measuring offset with a linear moved system" on page 53 and chapter "8.4.1.5.3. Inkremental-measuring system" on page 49.

Solution:

Check the input of the measuring system setting.
Consult the handbook of your measuring system.

When the error is corrected you can clear the error message by pressing the  key.

10.5. Problem: A "Pos - Err:" occurs during operation.

The display shows "Pos - Err: 1", "Pos - Err: 2" or "Pos - Err: 3".

Possible causes:

The connection cable of the measuring system or the measuring system itself do not function correctly. You are using an unshielded cable. Also, having your cable somewhere near a strong source for electro-magnetic disturbance (e.g. a power current cable, gear cable) can lead to a 'Pos - Error'.

Solution:

Check the wiring to the measuring system.
Replace the measuring system.
Take shielding precautions.
Move the path of your cable.
Consult the handbook of your measuring system.

When the error is corrected you can clear the error message by pressing the  key.

10.6. Problem: Outputs will not activate

Possible causes:

An error message is being displayed. There is no supply voltage on the outputs. (ONLY for CamCon DC115: The outputs were not cleared with a new start of the system or the control inputs are blocked by the S5. The control inputs of the CamCon are blocked by an S5 via the S5-L1 interface.

Solution:

Check the displayed error message.
Start the CamCon via the S5 or clear the control inputs.
See chapter 14.2.1. 00h-01h: task => "Start CamCon DC115" on page 82 and chapter 14.3.4. 01h-04h: Priority task => "Transfer CamCon controlling inputs" on page 95.

10.7. Problem: Display shows "Out - Error".

Possible causes:

Your outputs are overloaded or have short-circuited. Check the wiring and the connection power, as well as possible inductive loads operation without free wheeling diodes.

The number of set inputs is not correct.

One of the extension modul (e.g. DC91/IO or DC16/IO) lost powersupply.

Solution:

See chapter "5.3. The outputs" on page 26.

See chapter "8.4.6. System upgrading" on page 61.

When the error is corrected you can clear the error message by pressing the  key. The CamCon tries now to reset the outputs.



Attention: *Contact wirings after the outputs leads to the deactivation of the outputs, if you have a disadvantageous cable routing, since a potential is built up in the open state, that is reconducted into the outputs closing the contact.*

With inductive loads the outputs have to be switched with a freewheeling diode. Covers or inductivities very close to the device inside the switchboard have to be switched with a deletion unit as do those that are wired to or influence the wiring of the device.

10.8. Problem: Display shows an error in the EEPROM.

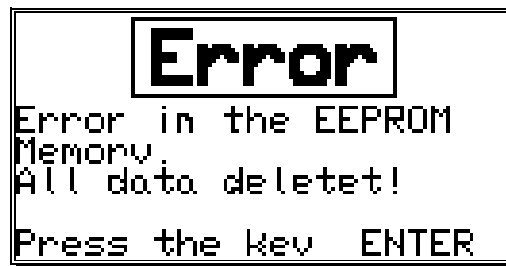

Possible causes:

The data of the EEPROM were altered or destroyed by a disturbance

At least one of the available data carriers (EEPROM or EPROM) has been replaced or has an error.

Solution:

Press the  key, and reenter all data.

Please contact your customer service.

10.9. Problem: Display shows "Error ???"

Possible causes:

An unpredictable error has occurred.

Solution:

Please contact your customer service.

10.10. Problem: Display shows "Clear...."

Cause:

Using an incremental measuring system, the CamCon is waiting to receive the clear signal.

Solution:

Supply a clear signal, and then the CamCon is enabled.

Attention: The incremental measuring system is only available for the CamCon DC16, DC50/51 and DC115.

See chapter "8.4.1.5.3. Inkremental-measuring system" on page 49.

12. Calculation of the EEPROM cam memory

You can upgrade the CamCon' s **EEPROM** cam memory up to 32kBytes. The memory needed for programming depends on the following factors:

1. basic needs	128 Bytes
2. per cam	12 Bytes
3. per selected dead time	12 Bytes
4. per output name	24 Bytes
5. per configured user key	66 Bytes
6. for a special measuring system	66 Bytes
7. for direct or "on Pos." programselection	12 Bytes
8. per program name	48 Bytes

The value is generated by the CamCon with the following formula:

Memory needs in Bytes = basic needs
+ number of cams * 12
+ number of dead times * 12
+ number of output names * 24
+ number of user keys * 66
+ 66, if using a special measuring system
+ 12, if program selection is set to "on Pos."
+ 48 * number of program name

Example 1: The cam controller is supposed to have 8 programs with 16 cams each, as well as dead time compensation for 16 outputs.

Memory needs in Bytes = 128 Bytes + (8 programs * 16 * 12 Bytes) + (16 * 12 Bytes)

Memory needs = 1856 Bytes

Beacuse the standard version is equipped with 2048 Bytes, there is no reason to upgrade the memory.

Example 2: The cam controller is supposed to have 20 programs with 16 cams and 16 dead times each.

Memory needs in Bytes = 128 Bytes
+ (20 program * 16 * 12 Bytes)
+ (16 DTC * 12 Bytes)
+ (16 output names * 24 Bytes)
+ (1 user kaey * 66 Bytes)

Memory needs = 4610 Bytes

Since the standard version of the CamCon is only equipped with 2048, an upgrade of the EEPROM memory is absolutely necessary.

13. Calculation of the RAM memory of the CamCon

You can upgrade the **RAM** memory of the CamCon up to 1MB (this does not refer to the fixed-value cam memory or the EEPROM). The needed memory depends on the following factors:

1. basic needs (about 25000 Bytes)
2. number of outputs (8 to 200 in steps of 8 outputs)
3. cycle time (value in milli seconds)
4. actual position/measuring system resolution (vom Speicherplatz abhängig)
5. maximum dead time compensation (0 to 9999.9 in steps of 100 micro seconds)
6. the program selection mode (you need 2 * the memory)
(See chapter "8.4.6.6. Setting the program selection mode" on page 62)
7. size of the EE-Prom memory (1/6 of the EE-Prom RAM memory is required).

The RAM - memory needs are generated with the following formula:

Memory needs in Bytes =

$$\begin{aligned} & \text{basic needs} \\ & + \\ & \frac{\text{number of outputs} * \text{act. pos. resolution} * (2 \text{ if program mode not "slow"})}{8} \\ & + \\ & \frac{\text{max. dead time} * 4}{\text{cycle time}} + \frac{\text{EE-prom size}}{6} \end{aligned}$$

Example 1: Calculation of the memory needs of a CamCon with a resolution of 360°, an EE-Prom memory of 32kByte, 16 outputs, a dead time compensation of 1000ms and a cycle time of 250µs:

$$\text{Memory needs in Bytes} = 25000 + \frac{16 * 360}{8} + \frac{1000 * 4}{0.250} + \frac{32768}{6}$$

$$\text{Memory needs in Bytes} = 25000 + 720 + 16000 + 5462$$

$$\text{Memory needs in Bytes} = 47182$$

$$\text{Memory needs in kByte} = \text{about } 47$$

The standard configuration of 32kByte is no longer adequate, so you will have to upgrade the memory.

Example 2: Calculation of a cam controller with a resolution of 360°, an EE-Prom memory of 2kByte, 16 outputs, a dead time compensation of 200ms and a cycle time of 250µs:

$$\text{Memory needs in Bytes} = 25000 + \frac{16 * 360}{8} + \frac{200 * 4}{0.250} + \frac{2048}{6}$$

$$\text{Memory needs in Bytes} = 25000 + 720 + 3200 + 342$$

$$\text{Memory needs in Bytes} = 29262$$

$$\text{Memory needs in kByte} = \text{about } 30$$

An upgrading of the memory is not necessary, since the standard configuration of 32kByte is still sufficient enough.

14. Kachel communication between S5 and CamCon DC115

The communication is realised with Dualported-RAM (Kachelram). Two status bytes serve for the control of the two-way communication. After the activation of the component group a "Start CamCon DC115" 00h,01h command or a "Programming-Parameter and Start CamCon" (00h,02h) command are sent to put the CamCon DC115 into operation mode.

14.1. Kachel allocation

The fields of the table "S5" with the symbol "<-->" express, that the S5 **and** the CamCon can read and write data. The symbol "<--" shows, that the S5 can only read data. ADR-HEX is the offset for the Kachel base address in the S5. With an AG115U the base address is at F400h.

14.1.1. Kachel range independent of task

S5	ADR-HEX	description	
<-->	000h	task / protocol byte	01h-7Fh=task 80h=protocol OK 81h-FFh=error
<-->	001h	priority-task / protocol byte	01h-7Fh=task 80h=protocol OK 81h-FFh=error
<--	002h	CamCon -ID	4Eh => ('N')
<--	003h	number of outputs	mostly 28h (40 outputs)
	004h	free	
	005h	free	
	006h	free	
	007h	free	
<-->	008h	Shifting of the zero point	High Byte
	009h		Low Byte
	00Ah	free	
	00Bh	free	
	00Ch	free	
	00Dh	free	
	00Eh	free	
	00Fh	free	
	010h	free	
	011h	free	
<--	012h	Number of asynchronous Cycles with a PLL measuring system	
<-->	013h	Status bits	
		bit 0 = actual position error or CamCon operates asynchronous with a PLL measuring system	
		bit 1 = output error	
		bit 2 = program selection process is active	
		bit 3 = 24V supply is momentarily not connected	
		bit 4 = 24V supply was interrupted	
		bit 5 = free	
		bit 6 = CamCon waits for the starting command via the S5	
		bit 7 = trigger for zero value of the actual position	
<-->	014h	Current cam program	High Byte
	015h	-"	Low Byte
<-->	016h	Future cam program	High Byte
	017h	-"	Low Byte
<--	018h	Current position	High Byte
<--	019h	-"	Low Byte
<--	01Ah	Current speed	High Byte
<--	01Bh	-"	Low Byte

S5	ADR-HEX	description
<-->	01Ch	State of outputs or controlling inputs 9-16
<-->	01Dh	State of outputs or controlling inputs 1-8
<-->	01Eh	State of outputs or controlling inputs 25-32
<-->	01Fh	State of outputs or controlling inputs 17-24
<-->	020h	State of outputs or controlling inputs 41-48
<-->	021h	State of outputs or controlling inputs 33-40
<-->	022h	State of outputs or controlling inputs 57-64
<-->	023h	State of outputs or controlling inputs 49-56
<-->	024h	State of outputs or controlling inputs 73-80
<-->	025h	State of outputs or controlling inputs 65-72
<-->	026h	State of outputs or controlling inputs 89-96
<-->	027h	State of outputs or controlling inputs 81-88
<-->	028h	State of outputs or controlling inputs 105-112
<-->	029h	State of outputs or controlling inputs 97-104
<-->	02Ah	State of outputs or controlling inputs 121-128
<-->	02Bh	State of outputs or controlling inputs 113-120
<-->	02Ch	State of outputs or controlling inputs 137-144
<-->	02Dh	State of outputs or controlling inputs 129-136
<-->	02Eh	State of outputs or controlling inputs 153-160
<-->	02Fh	State of outputs or controlling inputs 145-152
<-->	030h	State of outputs or controlling inputs 169-176
<-->	031h	State of outputs or controlling inputs 161-168
<-->	032h	State of outputs or controlling inputs 185-192
<-->	033h	State of outputs or controlling inputs 177-184
	034h	free
<-->	035h	State of outputs or controlling inputs 193-200
	036h	free
<--	037h	Short circuit report of the outputs bit 0 = 1-8 bit 1 = 9-16 bit 2 = 17-24 bit 3 = 25-32 bit 4 = 33-40
	038h	free
	039h	free
	03Ah	free
	03Bh	free
	03Ch	free
	03Eh	free
	03Fh	free

14.1.2. Kachel range dependent on task

S5	ADR-HEX	description
<-->	040h	task data for 00h tasks
<-->	041h	-"-
<-->	042h	-"-
<-->	.	-"-
<-->	.	-"-
<-->	3f fh	task data for 00h tasks

14.2. Tasks

14.2.1. 00h-01h: task => "Start CamCon DC115"

ADR-HEX	description
000h	01h = task "Start CamCon DC115"

14.2.1.1. 00h-01h: protocol => "Start CamCon DC115"

ADR-HEX	description
000h	80h = protocol Ok, Start is finished
	81h-ffh = protocol not Ok with error number

14.2.2. 00h-02h: task => "Program-Parameter and Start CamCon DC115"

ADR-HEX	description		handbook page
000h	02h = task "Program-Parameter"		
040h	PLC at cam controller (0=off, 1=on)	High Byte	PLC Logic
041h	"-"	Low Byte	Module
042h	Physical inputs (0-200)	High Byte	PLC Logic
043h	"-"	Low Byte	Module
044h	Physical outputs (0-200)	High Byte	page 61
045h	"-"	Low Byte	
046h	Cam controller inputs (0-200)	High Byte	page 61
047h	"-"	Low Byte	
048h	Cam controller outputs (0-200)	High Byte	page 61
049h	"-"	Low Byte	
04ah	Cam controller outputs with dead time compensation (0-200)	High Byte	page 61
04bh	"-"	Low Byte	
04ch	Registers for PLC (0-200)	High Byte	PLC Logic
04dh	"-"	Low Byte	Module
04eh	Timer/Counter for PLC (0-200)	High Byte	PLC Logic
04fh	"-"	Low Byte	Module
050h	Virtual inputs for S5 coupling via Kachel (0-200)	High Byte	PLC Logic
051h	"-"	Low Byte	Module
052h	Special inputs with extra functions for PLC (0-200)	High Byte	PLC Logic
053h	"-"	Low Byte	Module
054h	Security output (0-200, 0= not security output)	High Byte	page 57
055h	"-"	Low Byte	
056h	Program selection mode (0-slow, 1=direct, 2=on position)	High Byte	page 62
057h	"-"	Low Byte	
058h	1. input for external program selection	High Byte	page 61
059h	"-" (0-200, 0 = no external program selection)	Low Byte	
05ah	Number of externally selectable programs	High Byte	page 61
05bh	"-" (0-32768 in binary steps)	Low Byte	
05ch	Actual position for program selection mode 2	High Byte	page
05dh	"-"	Low Byte	
05eh	Send actual position on QSM	High Byte	page 58
05fh	"-" (0=No, 1=Gray, 2=Binary, 3=Gray for slave expansion)	Low Byte	
060h	Plan cycle time	High Byte	page 57
061h	"-"	Low Byte	
062h	Actual position hysteresis	High Byte	page 57
063h	"-"	Low Byte	
064h	F/R output (0-200, 0=no F/R output)	High Byte	page 58
065h	"-"	Low Byte	
066h	V <> 0 output (0-200, 0= no V <> 0 output)	High Byte	page 58
067h	"-"	Low Byte	

ADR-HEX	description							handbook page	
068h	F/R hysteresis (0-64000)							page 58	
069h	"-"								
06ah	Cable length in meter s							page 57	
06bh	"-"								
06ch	Speed factor (0,000 - 64,000)							page 55	
06dh	"-" for 32 bit value, see (096h) = 32 Bit speed factor								
06eh	Speed 100% (0 - 64000)							page 55	
06fh	"-"								
070h	Speed accuracy and dampening (0,0000% - 6,4000%)							page 55	
071h	"-"								
072h	Gear factor multiplier (-32000-+32000)							page 47	
073h	"-"								
074h	Gear factor divisor (1-64000)							page 47	
075h	"-"								
076h	Standard measuring systems							page 46	
077h	"-" FFFFh = special measuring system (see next line 078h) 0=256, 1=360, 2=512, 3=1000, 4=1024, 5=2048, 6=4096, 7=8192 Gray Singelturn encoder								
078h	measuring system type							page 48	
079h	"-" 0=Gray 1=Parallel 2=Inc. 3=Multi 4=PLL 5=Timer 6=RS232								
07ah	High	resolution	resolution	resolution	resolution	impulse/ input	resolution	resolution	
07bh	Low	in bit							
07ch	High	offset		predivisor in	turns	clear value	time per	predivisor in	
07dh	Low	in bit		binary			step (ms)	binary	
07eh	High	separation			divisor	error		protocol	
07fh	Low					window			
080h	High	error bit	input from			impulse inp.	stop input	Baud	
081h	Low								
082h	High			clear mode		clear input	clear input		
083h	Low								
084h	High					sync. output			
085h	Low								
086h	087h	088h	089h	reserved					
08ah	Measuring system result							page 53	
08bh	"-" 0=rotatory 1=linear								
08ch	High						starting value		
08dh	Low								
08eh	Zero point / Offset							page 53	
08fh	"-"							page 53	
090h	Preset input (0-200, 0=not)							page 54	
091h	"-"								
092h	Preset Mode (0=RAM,1=EEPROM)							page 54	
093h	"-"								
094h	Preset value							page 54	
095h	"-"								
096h	Speed factor (0,000 - 9999,99999)							page 55	
097h	"-"								
098h	"-"								
099h	"-"								
Speed factor as 32 bit value, This value is only use if the 16 bit speed factor (06ch) = 0.									

14.2.2.1. 00h-02h: protocol => "Program-Parameter and Start CamCon DC115"

ADR-HEX	description
000h	80h = protocol Ok, parameter programming finished and CamCon Dc115 started 81h-ffh = protocol not Ok with error number

14.2.3. 00h-03h: task => "Read-Parameter"

ADR-HEX	description
000h	03h = task "Read-Parameter"

14.2.3.1. 00h-03h: protocol => "Read-Parameter"

ADR-HEX	description	handbook page
000h	80h = protocol Ok, parameter and stored in Kachelram 81h-ffh = protocol not Ok with errornumber	
040h	PLC in cam controller (0=off, 1=on)	High Byte PLC Logic
041h	"-"	Low Byte Module
042h	Physical inputs (0-200)	High Byte PLC Logic
043h	"-"	Low Byte Module
044h	Physical outputs (0-200)	High Byte page 61
045h	"-"	Low Byte
046h	Cam controller inputs (0-200)	High Byte page 61
047h	"-"	Low Byte
048h	Cam controller outputs (0-200)	High Byte page 61
049h	"-"	Low Byte
04ah	Cam controller outputs with dead time compensation (0-200)	High Byte page 61
04bh	"-"	Low Byte
04ch	Registers for PLC (0-200)	High Byte PLC Logic
04dh	"-"	Low Byte Module
04eh	Timer/Counter for PLC (0-200)	High Byte PLC Logic
04fh	"-"	Low Byte Module
050h	Virtual inputs for S5 coupling via Kachel (0-200)	High Byte PLC Logic
051h	"-"	Low Byte Module
052h	Special inputs with extra functions for PLC (0-200)	High Byte PLC Logic
053h	"-"	Low Byte Module
054h	Security output (0-200, 0= no security output)	High Byte page 57
055h	"-"	Low Byte
056h	Program selection mode (0=slow, 1=direct, 2=on position)	High Byte page 62
057h	"-"	Low Byte
058h	1. input for external program selection	High Byte page 61
059h	"-" (0-200, 0 = no external program selection)	Low Byte
05ah	Number of externally selectable programs	High Byte page 61
05bh	"-" (0-32768 in binary steps)	Low Byte
05ch	Actual position for program selection mode 2	High Byte page 61
05dh	"-"	Low Byte
05eh	Actual position sent on QSM	High Byte page 58
05fh	"-" (0=No, 1=Gray, 2=Binary, 3=Gray for Slave-Expansion)	Low Byte
060h	Actual cycle time	High Byte page 57
061h	"-"	Low Byte
062h	Actual position hysteresis	High Byte page 57
063h	"-"	Low Byte
064h	F/R output (0-200, 0=no F/R output)	High Byte page 58
065h	"-"	Low Byte
066h	V <> 0 output (0-200, 0= no V <> 0 output)	High Byte page 58
067h	"-"	Low Byte
068h	F/R hysteresis (0-64000)	High Byte page 58
069h	"-"	Low Byte
06ah	Cable length in meters	High Byte page 57
06bh	"-"	Low Byte
06ch	Speed factor (0,000 - 64,000)	High Byte page 55
06dh	"-" for 32 bit value, see (096h) = 32 Bit speed factor	Low Byte

ADR-HEX	description						handbook page	
06eh	Speed 100% (0 - 64000)						High Byte	page 55
06fh	"-"						Low Byte	
070h	Speed accuracy and dampening (0,000% - 6,400%)						High Byte	page 55
071h	"-"						Low Byte	
072h	Gear factor multiplier (-32000-+32000)						High Byte	page 47
073h	"-"						Low Byte	
074h	Gear factor divisor (1-64000)						High Byte	page 47
075h	"-"						Low Byte	
076h	Standard measuring systems						High Byte	page 46
077h	"-"						Low Byte	
FFFFh = Special measuring system (see next line 078h) 0=256, 1=360, 2=512, 3=1000, 4=1024, 5=2048, 6=4096, 7=8192 Gray Singelturn encoder								
078h	Measuring system type						High Byte	page 48
079h	"-"						Low Byte	
0=Gray 1=Parallel 2=Inc. 3=Multi 4=PLL 5=Timer 6=RS232								
07ah High	resolution	resolution	resolution	resolution	impulse/	resolution	resolution	
07bh Low	in bit				input			
07ch High	offset		predivisor in	turns	clear value	time per	predivisor in	
07dh Low	in bit		binary.			step (ms)	binary	
07eh High	separation			divisor	error		protocol	
07fh Low					window			
080h High	error bit	input from			impulse inp.	stop input	Baud	
081h Low								
082h High			clear mode		clear input	clear input		
083h Low								
084h High					Sync output			
085h Low								
086h 087h 088h 089h	reserved							
08ah	Measuring system result						High Byte	page 53
08bh	"-"						Low Byte	
0=rotatory 1=linear								
08ch High					starting value			
08dh Low								
08eh	Zero point / Offset						High Byte	page 53
08fh	"-"						Low Byte	page 53
090h	Preset input (0-200, 0=not)						High Byte	page 54
091h	"-"						Low Byte	
092h	Preset mode (0=RAM,1=EEPROM)						High Byte	page 54
093h	"-"						Low Byte	
094h	Preset value						High Byte	page 54
095h	"-"						Low Byte	
096h	Speed factor	(0,000 - 9999,9999)			MSB	bit 24 to 31	page 55	
097h	"-"					bit 16 to 23		
098h	"-"					bit 8 to 15		
099h	"-"				LSB	bit 0 to 7		
Speed factor as 32 bit value, see (06ch) = 16 Bit speed factor.								

14.2.4. 00h-04h: task => "Cam program deletion"

ADR-HEX	description	
000h	04h = task "Cam program deletion"	
040h	Cam program to be deleted	High Byte
041h	-"	Low Byte
	8000h = All cam programs are deleted	

14.2.4.1. 00h-04h: protocol => "Cam program deletion"

ADR-HEX	description	
000h	80h = protocol Ok, cam program is deleted	
	81h-ffh = protocol not Ok with error number	

14.2.5. 00h-05h: task => "Test on cam program exists"

ADR-HEX	description	
000h	05h = task "Test on cam program exists"	
040h	Cam program to be tested	High Byte
041h	-"	Low Byte

14.2.5.1. 00h-05h: protocol => "Test on cam program exists"

ADR-HEX	description	
000h	80h = protocol Ok, Test is finished	
	81h-ffh = protocol not Ok with error number	
042h	Reply to cam program exists	
	01h	Program exists
	FEh	Program does not exist

14.2.6. 00h-06h: task => "Program cam program"

ADR-HEX	description	handbook page
000h	06h = task "Program cam program"	
040h	Cam program number	High Byte
041h	"-"	Low Byte
042h	Switching point of the cam program	High Byte
043h	"-"	Low Byte
044h	Switching mode of the cam program (0=normal, 1=fast, 2=on switching point)	
045h	reserved	
046h	reserved	
	.	
	.	
051h	reserved	
052h	Output number (cam track) 1-200	
053h	Number of following cam's 0-235 (0=cam track deletion)	
054h	Activation point cam 1	High Byte
055h	"-"	Low Byte
056h	Deactivation point cam 1	High Byte
057h	"-"	Low Byte
058h	Activation point cam 2	High Byte
059h	"-"	Low Byte
05Ah	Deactivation point cam 2	High Byte
05Bh	"-"	Low Byte
	.	
	.	
xxxh	Activation point cam xx	High Byte
xxxh+1	"-"	Low Byte
xxxh+2	Deactivation point cam xx	High Byte
xxxh+3	"-"	Low Byte
xxxh+4	Output number (cam track) 1-200	
xxxh+5	Number of following cam's 0-235 (0=cam track deletion)	
xxxh+6	Activation point cam 1	High Byte
xxxh+7	"-"	Low Byte
xxxh+8	Deactivation point cam 1	High Byte
xxxh+9	"-"	Low Byte
	.	
	.	
xxxh+x	End ID = 0xFF	
xxxh+y	End ID = 0xFF	

Attention: Cam tracks not listed are neither programmed nor deleted !

14.2.6.1. 00h-06h: protocol => "Program cam program"

ADR-HEX	description
000h	80h = protocol Ok, cam program is programmed 81h-ffh = protocol not Ok with error number

14.2.7. 00h-07h: task => "Read cam program"

ADR-HEX	description	
000h	07h = task "Read cam program"	
040h	Cam PRG No.	High Byte
041h	-"	Low Byte

14.2.7.1. 00h-07h: protocol => "Read cam program"

ADR-HEX	description	handbook page
000h	80h = protocol OK, cam program read. 81h-ffh = protocol not Ok with error number	
040h	Cam program number	High Byte
041h	-"	Low Byte
042h	Switching point of the cam program	High Byte
043h	-"	Low Byte
044h	Switching mode of the cam program (0=normal, 1=fast, 2=at the switching point)	
045h	reserved	
046h	reserved	
	.	
	.	
051h	reserved	
052h	Output number (cam track) 1-200	
053h	Number of following cam's 0-235	
054h	Activation point cam 1	High Byte
055h	-"	Low Byte
056h	Deactivation point cam 1	High Byte
057h	-"	Low Byte
058h	Activation point cam 2	High Byte
059h	-"	Low Byte
05Ah	Deactivation point cam 2	High Byte
05Bh	-"	Low Byte
	.	
	.	
xxxh	Activation point cam xx	High Byte
xxxh+1	-"	Low Byte
xxxh+2	Deactivation point cam xx	High Byte
xxxh+3	-"	Low Byte
xxxh+4	Output number (cam track) 1-200	
xxxh+5	Number of following cam's 0-235	
xxxh+6	Activation point cam 1	High Byte
xxxh+7	-"	Low Byte
xxxh+8	Deactivation point cam 1	High Byte
xxxh+9	-"	Low Byte
	.	
	.	
xxxh+x	End ID = 0xFF	
xxxh+y	End ID = 0xFF	

Attention: Cam tracks not listed are not programmed.

14.2.8. 00h-0Bh: task => "Reset error message"

ADR-HEX	description
000h	0Bh = task "Reset error message" (actual position error, output error) See chapter "10. Error messages and error recovery" on page 74

14.2.8.1. 00h-0Bh: protocol => "Reset error message"

ADR-HEX	description
000h	80h = protocol Ok, error message reseted (actual position error, output error) 81h-ffh = protocol not Ok with error number

14.2.9. 00h-0Ch: task => "Program dead times"

ADR-HEX	description	
000h	0Ch = task "Program dead times"	
040h	Dead time compensation (in ms steps) output 1	High Byte
041h	free	Low Byte
042h	Dead time compensation (in ms steps) output 2	High Byte
043h	free	Low Byte
044h	Dead time compensation (in ms steps) output 3	High Byte
045h	free	Low Byte
	.	
	.	
	.	
1CEh	Dead time compensation (in ms steps) output 200	High Byte
1CFh	free	Low Byte

14.2.9.1. 00h-0Ch: protocol => "Program dead times"

ADR-HEX	description	
000h	80h = protocol Ok, dead times are programmed 81h-ffh = protocol not Ok with error number	

14.2.10. 00h-0Dh: task => "Read dead times"

ADR-HEX	description	
000h	0Dh = task "Read dead times"	

14.2.10.1. 00h-0Dh: protocol => "Read dead times"

ADR-HEX	description	
000h	80h = protocol Ok, dead times read 81h-ffh = protocol not Ok with error number	
040h	Dead time compensation (in ms steps) output 1	High Byte
041h	free	Low Byte
042h	Dead time compensation (in ms steps) output 2	High Byte
043h	free	Low Byte
044h	Dead time compensation (in ms steps) output 3	High Byte
045h	free	Low Byte
	.	
	.	
	.	
1CEh	Dead time compensation (in ms steps) output 200	High Byte
1CFh	free	Low Byte

14.2.11. 00h-0Eh: task => "Program PLC Logic Module output"

If you specified the options "PLC" or "PLC/INFO" with your order of the CamCon, you can program the PLC Logic Module of the CamCon via the S5, using the two tasks 0E and 0F. Read the handbook of the "CamCon PLC Logic Module" completely to get a better understanding of structure and functions of the PLC Logic Module. The inputs for tasks 0E and 0F are described in this handbook.

ADR-HEX	description			
000h	0Eh = task "Program PLC Logic Module output"			
040h	Output field		High Byte	
041h	"		Low Byte	
042h	Value for output field		High Byte	for timer and counter
043h	"		Low Byte	as well as text display
044h	Reset for counter output field		High Byte	
045h	"		Low Byte	
046h input field	052h input field	05Eh input field	06Ah input field	076h input field
047h 1.column,1.line	053h 2.column,1.line	05Fh 3.column,1.line	06Bh 4.column,1.line	077h 5.column,1.line
048h input field	054h input field	060h input field	06Ch input field	078h input field
049h 1.column,2.line	055h 2.column,2.line	061h 3.column,2.line	06Dh 4.column,2.line	079h 5.column,2.line
04Ah input field	056h input field	062h input field	06Eh input field	07Ah input field
04Bh 1.column,3.line	057h 2.column,3.line	063h 3.column,3.line	06Fh 4.column,3.line	07Bh 5.column,3.line
04Ch input field	058h input field	064h input field	070h input field	07Ch input field
04Dh 1.column,4.line	059h 2.column,4.line	065h 3.column,4.line	071h 4.column,4.line	07Dh 5.column,4.line
04Eh input field	05Ah input field	066h input field	072h input field	07Eh input field
04Fh 1.column,5.line	05Bh 2.column,5.line	067h 3.column,5.line	073h 4.column,5.line	07Fh 5.column,5.line
050h input field	05Ch input field	068h input field	074h input field	080h input field
051h 1.column,6.line	05Dh 2.column,6.line	069h 3.column,6.line	075h 4.column,6.line	081h 5.column,6.line

14.2.11.1. 00h-0Eh: protocol => "Program PLC Logic Module output"

ADR-HEX	description
000h	80h = protocol Ok, PLC Logic Module output is programmed 81h-ffh = protocol not Ok with error number

14.2.12. 00h-0Fh: task => "Read PLC Logic Module output"

ADR-HEX	description	
000h	0Eh = task "Read PLC Logic Module output"	
040h	Output field (enter only number and range)	High Byte
041h	"	Low Byte

14.2.12.1. 00h-0Fh: protocol => "Read PLC Logic Module output"

ADR-HEX	description			
000h	80h = protocol Ok, Read PLC Logic Module output 81h-ffh = protocol not Ok with error number			
040h	Output field	High Byte		
041h	"	Low Byte		
042h	Value for output field	High Byte	for timer and counter	
043h	"	Low Byte	as well as text display	
044h	Reset for counter output field	High Byte		
045h	"	Low Byte		
046h input field	052h input field	05Eh input field	06Ah input field	076h input field
047h 1.column,1.line	053h 2.column,1.line	05Fh 3.column,1.line	06Bh 4.column,1.line	077h 5.column,1.line
048h input field	054h input field	060h input field	06Ch input field	078h input field
049h 1.column,2.line	055h 2.column,2.line	061h 3.column,2.line	06Dh 4.column,2.line	079h 5.column,2.line
04Ah input field	056h input field	062h input field	06Eh input field	07Ah input field
04Bh 1.column,3.line	057h 2.column,3.line	063h 3.column,3.line	06Fh 4.column,3.line	07Bh 5.column,3.line
04Ch input field	058h input field	064h input field	070h input field	07Ch input field
04Dh 1.column,4.line	059h 2.column,4.line	065h 3.column,4.line	071h 4.column,4.line	07Dh 5.column,4.line
04Eh input field	05Ah input field	066h input field	072h input field	07Eh input field
04Fh 1.column,5.line	05Bh 2.column,5.line	067h 3.column,5.line	073h 4.column,5.line	07Fh 5.column,5.line
050h input field	05Ch input field	068h input field	074h input field	080h input field
051h 1.column,6.line	05Dh 2.column,6.line	069h 3.column,6.line	075h 4.column,6.line	081h 5.column,6.line

14.2.13. 00h-10h: task => "Complete deletion of the CamCon DC115"

ADR-HEX	description	handbook page
000h	10h = task "Complete deletion of the CamCon initiated "	page 65

14.2.13.1. 00h-10h: protocol => "Delete CamCon"

ADR-HEX	description
000h	80h = protocol Ok, deletion accomplished 81h-ffh = protocol not Ok with error number

14.3. Priority tasks

Priority tasks are processed by the CamCon DC115 parallel to the normal tasks. If e.g. a cam program is programmed, it is still possible to read the actual position and the status messages via the priority task "CamCon status read", and send the controlling outputs. After every priority task via the S5, a "Status read" task is automatically initiated.

14.3.1. 01h-01h: Priority task => "CamCon status read"

ADR-HEX	description
001h	01h = task "CamCon status read"

14.3.1.1. 01h-01h: Priority protocol => "CamCon status read"

ADR-HEX	description		
001h	80h = protocol Ok, status is read; 81h-ffh protocol not Ok with error number		
008h	Shifting of the zero point	High Byte	page 53
009h		Low Byte	page 53
00Ah	free		
00Bh	free		
00Ch	free		
00Dh	free		
00Eh	free		
00Fh	free		
010h	free		
011h	free		
012h	with PLL measuring system: the number of asynchronous PLL cycles		
013h	Status bits bit 0 = actual position error (asynchronous with a PLL measuring system) bit 1 = output error bit 2 = program selection is active bit 3 = 24V supply is momentarily not connected bit 4 = 24V supply was not connected bit 5 = bit 6 = CamCon DC115 waits for Start command bit 7 = trigger for zero value of the actual position		
014h	Active cam program	High Byte	
015h		Low Byte	
016h	Selected cam PRG	High Byte	
017h		Low Byte	
018h	Current position	High Byte	
019h		Low Byte	
01Ah	Current speed	High Byte	
01Bh		Low Byte	
01Ch	Status output 9-16		
01Dh	Status output 1-8		
01Eh	Status output 25-32		
01Fh	Status output 17-24		
020h	Status output 41-48		
021h	Status output 33-40		
022h	Status output 57-64		
023h	Status output 49-56		
024h	Status output 73-80		
025h	Status output 65-72		

ADR-HEX	description
026h	Status output 89-96
027h	Status output 81-88
028h	Status output 105-112
029h	Status output 97-104
02Ah	Status output 121-128
02Bh	Status output 113-120
02Ch	Status output 137-144
02Dh	Status output 129-136
02Eh	Status output 153-160
02Fh	Status output 145-152
030h	Status output 169-176
031h	Status output 161-168
032h	Status output 185-192
033h	Status output 177-184
034h	free
035h	Status output 193-200
036h	free
037h	Short circuit output 1-8,9-16,17,24,25-32,33-40
038h	free
039h	free
03Ah	free
03Bh	free
03Ch	free
03Dh	free
03Eh	free
03Fh	free

14.3.2. 01h-02h: Priority task => "Shifting the zero point"

ADR-HEX	description	handbook page	
001h	02h = task "Shifting the zero point and CamCon status read"		
008h	Shifting of the zero point	High Byte	page 53
009h		Low Byte	page 53

14.3.2.1. 01h-02h: Priority protocol => "Shifting the zero point"

ADR-HEX	description
001h	80h = protocol Ok, zero point is shifted and status read; 81h-ffh = protocol not Ok with error number

14.3.3. 01h-03h: Priority task => "Program selection"

ADR-HEX	description	handbook page
001h	03h = task "Program selection and CamCon status read"	
013h	Selection of the program selection mode 00h= use switching mode selected in program 01h= use entered switching point	page 62
014h	New cam program number	High Byte
015h	-"	Low Byte
016h	Use switching point of the cam program	High Byte
017h	-"	Low Byte

14.3.3.1. 01h-03h: Priority protocol => "Program selection"

ADR-HEX	description
001h	80h = protocol Ok, program selection accomplished and status read; 81h-ffh = protocol not Ok with error number

14.3.4. 01h-04h: Priority task => "Transfer CamCon controlling inputs"

With this task, the S5 can directly influence the behavior of the CamCon' s outputs. If the bits of the controlling inputs are set to "0" by the S5, the outputs of the CamCon DC115 are locked. These controlling bits are set to "1" (as a standard) after the activation of the CamCon. If the CamCon DC115 uses the optional PLC Logic Module, the controlling inputs are entered into the input area "V" of the PLC Logic Module (see also the handbook of the PLC Logic Module).

ADR-HEX	description
001h	04h = task "Transfer CamCon controlling inputs and CamCon status read"
01Ch	Controlling inputs 9-16
01Dh	Controlling inputs 1-8
01Eh	Controlling inputs 25-32
01Fh	Controlling inputs 17-24
020h	Controlling inputs 41-48
021h	Controlling inputs 33-40
022h	Controlling inputs 57-64
023h	Controlling inputs 49-56
024h	Controlling inputs 73-80
025h	Controlling inputs 65-72
026h	Controlling inputs 89-96
027h	Controlling inputs 81-88
028h	Controlling inputs 105-112
029h	Controlling inputs 97-104
02Ah	Controlling inputs 121-128
02Bh	Controlling inputs 113-120
02Ch	Controlling inputs 137-144
02Dh	Controlling inputs 129-136
02Eh	Controlling inputs 153-160
02Fh	Controlling inputs 145-152
030h	Controlling inputs 169-176
031h	Controlling inputs 161-168
032h	Controlling inputs 185-192
033h	Controlling inputs 177-184
034h	free
035h	Controlling inputs 193-200

14.3.4.1. 01h-04h: Priority protocol => "Transfer CamCon controlling inputs"

ADR-HEX	description
001h	80h = protocol Ok, Transferred controlling inputs and status read; 81h-ffh = protocol not Ok with error number

14.4. Error numbers in the protocol bytes (00h and 01h) of the CamCon DC115

ADR-HEX	description
80h	task accomplished and no error occurred
A0h	task number unknown
A1h	error at restart
AEh	proof total error in the EEPROM, command 00h,10h initializes the EEPROM !
AFh	EEPROM defect, EEPROM cannot be initialized
B1h	security output specified incorrectly
B2h	no memory space for selected measuring method
B3h	measuring system installation not successful
B4h	multiplier specified incorrectly
B5h	divisor specified incorrectly
B6h	dead time value specified incorrectly
B7h	dead time value specified incorrectly
B8h	no memory space for specified dead times
B9h	cam specified incorrectly
BAh	cam specified incorrectly
BBh	no memory space for cams
BCh	wrong output number specified
BDh	no further memory space for AND link
BEh	no further memory for NOT link
BFh	shifting of the zero point specified incorrectly
C2h	error at basic initialization: outputs cannot be specified
C3h	error at basic initialization: dead time outputs cannot be specified
C4h	error at basic initialization: inputs cannot be specified
C5h	error at basic initialization: external programs cannot be specified
C6h	error at basic initialization: inputs for program selection cannot be specified
C7h	error at basic initialization: PLC-Logic cannot be included
C8h	error at basic initialization: keyboard lock cannot be specified
C9h	error at basic initialization: analog outputs cannot be specified
CAh	error at basic initialization: PLC registers cannot be specified
CBh	error at basic initialization: PLC timers cannot be specified
CCh	error at basic initialization: virtual inputs of the PLC cannot be specified
CDh	error at basic initialization: special inputs of the PLC cannot be specified
CEh	error at basic initialization: actual position readout cannot be specified
CFh	error at basic initialization: F / R output cannot be specified
D0h	error at basic initialization: V0 output cannot be specified
D1h	error at basic initialization: V / R hysteresis cannot be specified
D2h	error at basic initialization: Cable length cannot be specified
E1h	wrong program number falsch
E2h	wrong program switching point
E3h	wrong program switching mode
E4h	wrong cam range
E5h	wrong PLC range

14.5. Example for Kachel communication between S5 and CamCon DC115

In this example, the controlling inputs of the CamCon DC115 are transferred from the data component in cycles (DW10 - 12) and the status of the CamCon DC115 is transferred back into the data component (DW0 - 7).

DB 101

0	:KM	= 00000000 00000000	Status
1	:KF	= +00000	Current Program
2	:KF	= +00000	Program to be selected
3	:KF	= +00112	Actual position
4	:KF	= +00159	Speed
5	:KM	= 00000000 00000000	Status output 16 - 9 8 - 1
6	:KM	= 00000000 00000000	Status output 32 - 25 24 - 17
7	:KM	= 00000000 00000000	Status output 48 - 41 40 - 33
8	:KF	= +00000	Reserved
9	:KF	= +00000	Reserved
10	:KM	= 00000000 00000000	Controlling input 16 - 9 8 - 1
11	:KM	= 00000000 00000000	Controlling input 32 - 25 24 - 17
12	:KM	= 00000000 00000000	Controlling input 48 - 41 40 - 33
13	:KF	= +00000	Reserved
14	:KF	= +00000	Reserved

FB 1

NETWORK 1

NAME	:RESTART	Restart
BEZ	:KNR	E/A/D/B/T/Z: D KM/KH/KY/KC/KF/KT/KZ/KG: KF
BEZ	:QUIT	E/A/D/B/T/Z: A BI/BY/W/D: BI
BEZ	:INIT	E/A/D/B/T/Z: A BI/BY/W/D: BI
	:LW =KNR	Load Kachel Nr. in ACCU 1
	:SPA FB 21	Proof on protocol expected.
NAME	:QUIT_NB	
	:UN M 255.0	If protocol is expected and
	:UN =QUIT	the own protocol was not
	:BEB	specified, then component end.
	:U =QUIT	If protocol is expected,
	:SPB =M001	then move to M001.
	:	Now task can be
	:LW =KNR	initiated.
	:T MB 255	Load Kachel Nr.
	:L KH EEFF	in Dummy register byte
	:L KH FFFF	Load address of MB255 at AG115
	:TNB 1	Transfer KNR to FFFF
	:L KH 0001	Load task 00,01
	:T MB 255	in Dummy register byte
	:L KH EEFF	Load address of MB255 at AG115
	:L KH F400	Transfer task to Kachel-
	:TNB 1	address 0
	:S =QUIT	Set registers, protocol is expected
M001	:	
	:LW =KNR	Wait for protocol
	:SPA FB 21	for normal task
NAME	:QUIT_NB	Kachelnummer in ACCU 1
	:U M 255.0	
	:S =INIT	If protocol was received,
	:RB =QUIT	set registers, command ends
	:BE	and reset protocol

FB 4

NETWORK 1

NAME	:CYCLE	
BEZ	:KNR	E/A/D/B/T/Z: D KM/KH/KY/KC/KF/KT/KZ/KG: KF
BEZ	:DATA	E/A/D/B/T/Z: D KM/KH/KY/KC/KF/KT/KZ/KG: KF
BEZ	:OFF	E/A/D/B/T/Z: D KM/KH/KY/KC/KF/KT/KZ/KG: KF
BEZ	:QUIT	E/A/D/B/T/Z: A BI/BY/W/D: BI
	:LW =KNR	Load Kachel Nr. in AKKU 1
	:SPA FB 20	Proof on protocol expected.
NAME	:QUIT_PB	
	:UN M 255.0	If protocol is expected and
	:UN =QUIT	the own protocol was not
	:BEB	specified, then component end.
	:U =QUIT	If protocol is expected,
	:SPB =M001	then move to M001.
	:	Now task can be
	:LW =KNR	initiated.
	:T MB 255	Load Kachel Nr.
	:L KH EEFF	in Dummy register byte
	:L KH FEFF	Load address of MB255 at AG115
	:TNB 1	Transfer KNR to FEFF
	:LW =DATA	Transfer controlling input from DB
	:SLW 1	DB number * 2
	:L KH E400	Base ADR DB0 at AG115
	:+F	ADD to base DB ADDRESS
	:LIR 0	get true ADDRESS of the DB
	:ADD KF +25	Set to last DB Address
	:LW =OFF	Load offset
	:+F	ADD offset
	:L KH F421	Set to Kachel start address
	:TNB 6	Transfer 6 Byte
	:L KH 0004	Load task 01,04
	:T MB 255	in Dummy register byte
	:L KH EEFF	Load address of MB255 at AG115
	:L KH F401	Except task according to Kachel address 1
	:TNB 1	
	:S =QUIT	Set registers, protocol is expected
M001	:	
	:LW =KNR	Wait for protocol
	:SPA FB 20	Kachel number in ACCU 1
NAME	:QUIT_PB	
	:U M 255.0	Once protocol is received,
	:RB =QUIT	then reset protocol.
	:UN M 255.0	If no protocol, then
	:BEB	Component end.
	:LW =DATA	Transfer data to DB
	:SLW 1	DB number * 2
	:L KH E400	Base ADR DB0
	:+F	ADD to base DB ADDRESS
	:LIR 0	get true ADDRESS
	:ADD KF +15	Set to last DB address
	:LW =OFF	Load offset
	:+F	ADD offset
	:L KH F421	Set to Kachel start address
	:TAK	Exchange ACCU 1 and 2
	:TNB 16	Transfer 16 Byte
	:BE	

FB 20

NETWORK 1

NAME :QUIT_PB Test if protocol is expected at priority task

:T MB 255 Kachel number at ACCU 1
:L KH EEFF Address of MB255 at AG115
:L KH FEFF
:TNB 1 Transfer to address FEFF
:L KH F401 Kachel address 01
:L KH EEFF Address of MB255 at AG115
:TNB 1 Transfer from F401 to EEFF
:L MB 255 Load Dummy register byte 255
:L KH 0080 Load 0x80 and compare. If larger
:>=F than or equal to,
:= M 255.0 protocol issued.
>F If only larger, then
:= M 0.0 error message of the DC115.
:UN M 0.0 If no error, the end of
:BEB component or
:TAK Exchange AKKU 1 and 2
:T MB 2 Error number in MB2
:BE

FB 21

NETWORK 1

NAME :QUIT_NB Test, if protocol is expected with normal task

:T MB 255 Kachel number in ACCU 1
:L KH EEFF Load address of MB255
:L KH FEFF
:TNB 1 Transfer KNR to FEFF
:L KH F400 Load Kachel address 0
:L KH EEFF Load address MB255
:TNB 1 Transfer F400 to EEFF
:L MB 255 Load MB255
:L KH 0080 Load 0x80 and compare. If
:>=F Larger than or equal to,
:= M 255.0 Protocol issued.
>F If just larger than,
:= M 0.0 Error message of the DC115.
:UN M 0.0 If no error, end of
:BEB Component or
:TAK Exchange AKKU 1 and 2
:T MB 2 Error number in MB2
:BE

FB 96

NETWORK 1

NAME :STARTUP Startup delay of the S5, so the CamCon
DC115 has time for its startup and
the setting of the Kachel number
:
:L KF +5000 Load 5000ms startup delay
:T BS 126 Transfer to operating system address 126.
:
:BE After de- and activation of the voltage supply,
the S5 is now started with delay.

OB 1

NETWORK 1

```
:
:UN M 100.0           Restart task not
:SPB FB 1             Accomplished yet.
NAME                 :RESTART
KNR                  :KF +1           Kachel No.
QUIT                 :M 100.1         registers for task busy
INIT                 :M 100.0         registers for task finished
:
:SPA FB 4             Status always read and
NAME                 :CYCLE          Controlling inputs always transfer
KNR                  :KF +1           Kachel number
DATA                 :KF +101        Data component number 101
OFF                  :KF +0          Offset for data component
QUIT                 :M 100.2        Registers for task: busy
:
:A DB 101            Transfer data from DB
:L DR 5              to the outputs.
:T AB 20
:L DL 5
:T AB 21
:L DR 6
:T AB 22
:L DL 6
:T AB 23
:
:L EB 24              Transfer the inputs to
:T DR 10              the controlling inputs of the DB.
:L EB 25
:T DL 10
:L EB 26
:T DR 11
:L EB 27
:T DL 11
:BE
```

OB 21

NETWORK 1

```
:L KH 0000           Protocol registers deletion
:T MB 100
:SPA FB 96
NAME                 :STARTUP
:BE
```

OB 22

NETWORK 1

```
:SPA OB 21
:BE
```

15. Technical Data

Number of outputs.....	40, galvanically separated to the S5 outputs 25 - 40 are connected to inputs 1 - 16.
Number of inputs.....	16, galvanically separated to the S5 inputs 1 - 16 are connected to outputs 25 - 40.
Number of cams for programming	150 or optionally 600, 2500 cams
Data security/storage	EEPROM
Number of programs	32768
Cycle time (switching speed).....	at least 0,1ms, can be adjusted as desired.
Dead time compensation (DTC)	individually for each output, according to measuring system and memory space.
Range of the DTC	0 up to 9999.9ms, according to measuring system and memory space.
Accuracy of the DTC	+0 to -1 step
Measuring system input	synchronous serial (SSI), Gray coded, optionally parallel data input, analog data input, PLL data input, time controlled data input.
Resolution of the measuring system	360 steps (standard) or according to measuring system and memory space.
Measuring system (standard type)	AAG60007 (360 Grad SSI).
Measuring system (SSI)	AAG60007, AAG612-2048, AAG612-4096, AAG612-8192, AAG626 or AAG66107.
Measuring system (incremental)	ADG60/24/500.
Border frequency of the incremental input	about 200kHz
Input level of the incremental input	5V RS422 or 24V PNP.
Zero point correction of the measuring system	is programmed with CamCon
Rotation direction of the measuring system	is programmed with CamCon
Length of the connection cable between measuring system and CamCon	with SSI up to 300m (optionally up to 1000m)
Supply voltage.....	24V DC \pm 20 %
Measuring system supply voltage	with 24V DC via the supply voltage of outputs 1 - 8.
Current absorbtion	300mA without measuring system and outputs
Output voltage.....	24V DC, plus switching
Output current	0,5A per output, short circuit proof
Programming.....	via PC with software DIGISOFT for DC16/40/50/90/115, CamCon DC50/51 Terminal or Kachel communication with the S5.
Connections for:	
Measuring system	DSUB 15 block-plug
Voltage supply.....	via block-pins IP20
Cam outputs.....	via block-pins IP20
Assembly.....	see chapter 4. Mechanical installation instructions on page 17.
Cover type	assembled: IP20
Operating temperature	0°C ... + 55° C
Weight.....	about 600g

16. Keyword table

Actual position preset.....	54
Actual position, Output.....	58
Adding cams.....	37
Adding cams, Example.....	42
Analog cam, Adding.....	45
Analog cam, Changing.....	45
Analog cam, Configuration.....	59
Analog cam, First creation.....	45
Analog cams, Programming.....	44
Analog measuring system input.....	25
Analog output, Soldering bridges.....	15
Analog outputs.....	69
Analog outputs, adjusting.....	69
Analog outputs, Clearing integrated.....	69
Analog outputs, External.....	69
Analog, Position output.....	60
Analog, Speed output.....	59
Assembly.....	17
Cable length.....	57
Cam deletion.....	38
Cam input.....	36
Cam programming.....	34
Cam search.....	37
Cam track, Deletion.....	38
Cam-BUS.....	66
Clear.....	76
Commissioning.....	30
Communication mode.....	66
Complete deletion.....	65
Configuration.....	12
Connection plugs, Component side.....	14
Connections.....	18
Copying cam tracks.....	39
Copying programmed outputs.....	39
Copying programs.....	40
Cycle time.....	57
Dead time compensation, Effects.....	9
Dead time, Calculation.....	11
Deleting programs.....	40
Deletion of a particular cam, Example.....	43
Device info.....	71
DIP switch S1.....	13
DIP switch S3.....	13
DIP switches.....	13
Direction output.....	58
Dis.input. with analog cams.....	60
Dis.value with analog cams.....	60
Display format, Actual position.....	47
Display, Change.....	32
Display, Standard.....	32
Display, Type.....	56
EEPROM cam memory, Calculation.....	78
EEPROM, Error.....	76
Error messages.....	74
Examples for cam programming.....	41

External interface	19
External program selection, Setting	61
Gear, Electronic	47
Hysteresis.....	58
Hysteresis, Actual position	46
Incremental measuring system input	24
Incremental measuring system, Configuration.....	49
Input of text	29
Input wiring.....	26
Inputs, General information.....	26
Inputs, Setting	61
Inputs, Status display	32
Installation instructions.....	17
Interpol. with analog cams	60
Kachel number (address).....	13
Key functions, Outline	28
Keyboard lock, Setting	61
Keys, Checking	64
Language	70
Linear system, Measuring offset	53
Main menu	32
Measuring offset.....	53
Measuring system	46
Measuring system, General information	23
Measuring system, Selection	46
Measuring system, Soldering bridges	16
Menu outline.....	77
Menu point, Selection.....	28
Menu, Selection.....	28
millenium	2
Movement direction, Change	47
Multiturn measuring system with electronic gear	50
Multiuser.....	66
No contact to unit XX	74
Offset.....	53
Options, Additional	67
Out - Error	76
Output name, Programming.....	36
Output selection for programming.....	34
Output, Deletion	38
Outputs with DTC, Setting.....	61
Outputs, General information.....	26
Outputs, Setting.....	61
Outputs, Status display	32
Parallel Gray special measuring system	49
Parallel measuring system input	23
PC software.....	27
Pin allocation.....	18
Pin allocation, 24 Volt incremental measuring system.....	18
Pin allocation, 24 Volt PLL measuring system	18
Pin allocation, 5 Volt incremental measuring system.....	18

Pin allocation, Analog output.....	21
Pin allocation, Inputs	21
Pin allocation, Outputs	21
Pin allocation, SSI measuring system.....	18
PLC Logic Module.....	67
PLC Logic Module with text display.....	68
PLC Logic Module, Examples.....	67
PLL measuring system.....	51
PLL measuring system input.....	25
Pos - Err 1	74
Pos - Err 2	74
Pos - Err 3	75
Preset.....	54
Program change.....	33
Program name	33
Program number	33
Program selection for programming.....	35
Program selection mode	62
Programming.....	34
Programming the dead time compensation, Private.....	35
Programming via remote.....	67
Programming, General information.....	27
RAM memory, Calculation	79
Reset behaviour	13
Rotation direction, Change.....	47
RS232 as a measuring system	25
RS232 measuring system	52
S5 - L1.....	66
Security output	57
Ser.mode.....	66
Serial interface	19
Serial interface RS232	19
Serial interface RS485	20
Serial interface, Configuration.....	66
Shifting cam tracks.....	39
Soldering bridges	15
Special measuring system	48
Special measuring system, Deletion.....	52
Special outputs.....	57
Speed adjustment	55
Speed display, Accuracy	56
Speed display, Display format.....	55
Speed display, Range adjustment.....	55
Speed factor.....	55
SSI measuring system	48
SSI measuring system input	23
Standard.....	66
Standstill output.....	58
System upgrading	61
Table of contents.....	3
Teach - In	37
Technical Data	101
Text input	29
The status LED	27
Time emitter measuring system simulation.....	51
Timer as a measuring system.....	25

Unit configuration	46; 63; 66
Unit number, Input.....	67
User key, Creation.....	63
User key, Deletion.....	64
User keys, Allocation.....	63
User text.....	70
Voltage supply of the CamCon.....	22
Welding operations, Safety precautions.....	26
Y2K.....	2
Zero offset	53
Zero offset, External.....	54