

CamCon Terminal

CT10



Digitronic Automationsanlagen GmbH

Steinbeisstraße 3 · D - 72636 Frickenhausen · Tel. +49 7022 40590-0 · Fax -10
Auf der Langwies 1 · D - 65510 Hünstetten-Wallbach · Tel. +49 6126 9453-0 · Fax -42
Internet: <http://www.digitronic.com> · E-Mail: mail@digitronic.com

For your attention

This instruction manual relates to the CamCon CT10 from 7/2000 and the CamCon software from 5/2006. The company Digitronic Automationsanlagen GmbH reserves the right to make changes which present an improvement of the quality or functionality of the device without prior notice. The instruction manual was created with great care, although it may not be error-proof. We would be grateful for any communication relating to any errors you may have found.

UP-date

You can also obtain this instruction manual on the Internet at <http://www.digitronic.com> in the latest version as PDF file.

Qualified personnel

This device may only be started and operated by qualified staff. By qualified we mean personnel who are entitled to handle, to earth and to label devices, systems and power circuits in accordance with the technology safety standards.

Liability

(1) The supplier is liable for damages caused by himself or by the owner of the rights up to the sum of the sales price. He is not liable for loss of profits, forfeited savings, intermediate and successive damages.

(2) The above mentioned limits to liability do not apply to insurance of named characteristics and damages which were caused deliberately or through negligence.

Protection

The CamCon CT10 and this instruction manual are protected by copyright. All rights are reserved. Neither the CamCon CT10, nor this document may be copied as a whole or partially, photocopied, reproduced, translated or transferred to electronic media of any kind or into machine readable format without prior written permission by the company Digitronic Automationsanlagen GmbH.

Note: We have examined the devices of the CamCon series for year 2000 compatibility and have not found any adverse effects on any functions.

Note: CamCon is a registered trademark of the company Firma Digitronic Automationsanlagen GmbH.

Note: The devices of the CamCon series comply with the standards for electromagnetic compatibility: EN 55011, EN 55022, EN 55024 Part 2, EN 50082 Part 2, ENV 50140, VDE 0843 Part 2, VDE 0843 Part 4, VDE 0871, VDE 0875 Part 3 ("N"), VDE 0875 Part 11, VDE 0877 Part 2, IEC 801 Part 3, IEC 801 Part 2, IEC 801 Part 4, IEC 801 Part 5.



(c) Copyright 1992 - 2009 / File: CT10_E.DOC

Digitronic Automationsanlagen GmbH
Auf der Langwies 1
D-65510 Hünstetten - Wallbach
Tel. (+49)6126/9453-0 Fax. (+49)6126/9453-42
Internet: <http://www.digitronic.com>
E-Mail: mail@digitronic.com

Table of contents

1. Introduction	5
2. Dimensions	5
2.1. Dimensions of the switch board cut out according to DIN 43700	5
3. Pin allocation.....	5
3.1. Pin allocation of the voltage supply.....	6
3.2. Pin allocation of the inputs	6
3.3. Pin allocation of the serial RS485 interface	6
4. Setting the DIP switch.....	7
4.1. Setting the unit number with DIP switch 1 - 4	7
4.2. Setting the communication mode via DIP switch 5.....	7
4.3. Setting of DIP switch 6.....	7
5. The inputs	8
5.1. Inputs 1 - 4	8
5.2. Inputs 5 + 6	8
6. Front view of the CamCon CT10 Terminal	8
6.1. The LED output display.....	8
6.2. The seven-segment display	8
6.3. The keyboard.....	9
6.3.1. Outline of the key functions.....	9
7. Commissioning	10
7.1. Device search mode	10
8. Programming	11
8.1. General deletion.....	11
8.2. Initialization of the system parameters.....	11
8.2.1. User keys for the system parameters	11
8.2.2. The encoder resolution	12
8.2.3. The electronic gear	12
8.2.4. The actual position hysteresis.....	12
8.2.5. Measuring system control	13
8.2.6. Reversing the rotation direction	13
8.2.7. Correction of the zero point.....	14
8.2.8. The speed factor.....	14
8.2.9. Adjusting the speed display	14
8.2.10. Accuracy of the speed display	14
8.2.11. Display type.....	15
8.2.12. Setting the cable length of the encoder	15
8.2.13. Setting the cycle time.....	15
8.2.14. Number of inputs	16
8.2.15. Number of outputs	16
8.2.16. Number of outputs with speed compensation.....	16
8.2.17. Keyboard lock	16
8.2.18. Input for error reset.....	16
8.2.19. Enable input	16
8.2.20. Setting the external program selection	16
8.2.21. Actual position preset or external shifting of the zero point	17
8.2.22. The security or SI output.....	17
8.2.23. The rotation direction or FR output	17
8.2.24. The stand still or V0 output	18
8.2.25. The speed hysteresis.....	18
8.2.26. Setup of the serial interface	18
8.2.27. Setting the unit number.....	19

8.2.28. Setting the programming mode	19
8.2.29. Releasing the analog outputs	19
8.2.29.1. Offset match for analog output 1	19
8.2.29.2. Amplification match for analog output 1.....	19
8.2.29.3. Matching analog output 2.....	19
8.3. Speed compensation	20
8.4. Cam programming in programming mode 0.....	20
8.4.1. Program selection	20
8.4.2. Output selection	20
8.4.3. Cam search	20
8.4.4. Base value	20
8.4.5. Changing the activation point.....	21
8.4.6. Changing the deactivation point.....	21
8.4.7. Exit cam programming.....	21
8.4.8. Examples for cam programming in programming mode 0	22
8.4.8.1. First cam programming.....	22
8.4.8.2. Programming additional cams on the same output	23
8.4.8.3. Deletion of a particular cam	24
8.5. Cam programming in programming mode 1.....	25
8.5.1. Program selection	25
8.5.2. Output selection	25
8.5.3. Changing the activation point.....	25
8.5.4. Changing the deactivation point.....	25
8.5.5. Exit cam programming.....	25
8.5.6. Examples for cam programming in programming mode 1	26
8.5.6.1. Cam programming.....	26
8.5.6.2. Cam deletion.....	26
8.6. Outline of operations.....	27
8.6.1. Change of the output display	27
8.6.2. Initialization of the system registers	27
8.6.3. Speed compensation programming.....	28
8.6.4. Cam programming.....	28
8.6.5. Display the unit configuration.....	29
9. Troubleshooting	30
9.1. Problem: The display remains dark after activation.....	30
9.2. Problem: The display shows: EE.Err	30
9.3. Problem: The display shows: I.Err 1	30
9.4. Problem: The display shows: I.Err 2	30
9.5. Problem: The display shows: I.Err 3	30
9.6. Problem: The display shows: I.Err 5	30
9.7. Problem: An error happens during operation.....	31
9.8. Problem : The display shows: A-Err.....	31
9.9. Problem: Outputs do not react.....	31
9.10. Problem : The display shows: t1.Err	32
9.11. Problem : The display shows: E.Full.....	32
10. Technical data.....	33
11. Key word table	33

1. Introduction

The CamCon CT10 Terminal is a 5 digit programming device for cam controllers of the CamCon series. The data transfer is made via the RS485 interface of the CamCon cam controllers. The programming of the CamCon CT10 Terminal is compatible to that of a CamCon DC40 cam controller. With it, you can program cam controllers DC16,40,50/51,90 and DC115.

Attention: The serial interface of the cam controller has to be set to "**Multiuser**" or "**Cam-Bus**", to be able to communicate with the CT10 Terminal. If you are using several CamCon CT10s or CD10s on a single RS485 - BUS or if you connect a PC, all devices (including the PC) have to be set to "**Cam-Bus**".
See chapter 4.2. Setting the communication mode via DIP switch 5 on page 7.

2. Dimensions

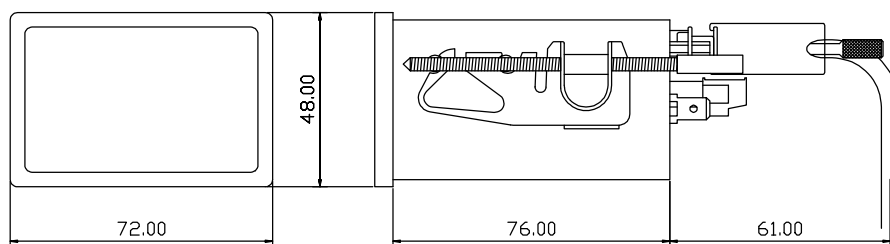

2.1. Dimensions of the switch board cut out according to DIN 43700

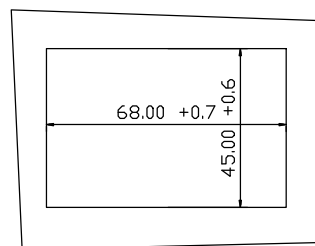

3. Pin allocation

PIN 1+4 = termination PIN 2 = RS485 B (-) PIN 3 = RS485 A (+) PIN 5 = RS485 GND PIN 6-9 = ext. Keyb.		DIP1=CT10 Unit 59-1 DIP2=CT10 Unit 59-2 DIP3=CT10 Unit 59-4 DIP4=CT10 Unit 59-8 DIP5=Cam-Bus/Multi. DIP6=CD10/CT10																					
Digitronic CE CamCon Terminal Type: CT10																							
		<table border="1"> <tr> <td>0V</td> <td>0V</td> <td>+24V</td> <td>+24V</td> <td>Input 1</td> <td>Input 2</td> <td>Input 3</td> <td>Input 4</td> <td>Input 5</td> <td>Input 6</td> </tr> <tr> <td>1</td> <td>2</td> <td>3</td> <td>4</td> <td>5</td> <td>6</td> <td>7</td> <td>8</td> <td>9</td> <td>10</td> </tr> </table>		0V	0V	+24V	+24V	Input 1	Input 2	Input 3	Input 4	Input 5	Input 6	1	2	3	4	5	6	7	8	9	10
0V	0V	+24V	+24V	Input 1	Input 2	Input 3	Input 4	Input 5	Input 6														
1	2	3	4	5	6	7	8	9	10														

3.1. Pin allocation of the voltage supply

Pin	1:	0V voltage supply
Pin	2:	0V voltage supply
Pin	3:	+24V DC voltage supply
Pin	4:	+24V DC voltage supply

3.2. Pin allocation of the inputs

Pin	5:	Input 1
Pin	6:	Input 2
Pin	7:	Input 3
Pin	8:	Input 4
Pin	9:	Input 5
Pin	10:	Input 6

3.3. Pin allocation of the serial RS485 interface

As a standard, the CamCon CT10 Terminal has a serial RS485 interface. It is connected to an RS485 interface of a CamCon DC16/40/50/90 or DC115. The cable length of an RS485 interface is limited to 1000 meters.

Pin	1,4:	Close-down resistors
Pin	2:	B (-)
Pin	3:	A (+)
Pin	5:	0V signal mass
Pin	6-9:	external keyboard

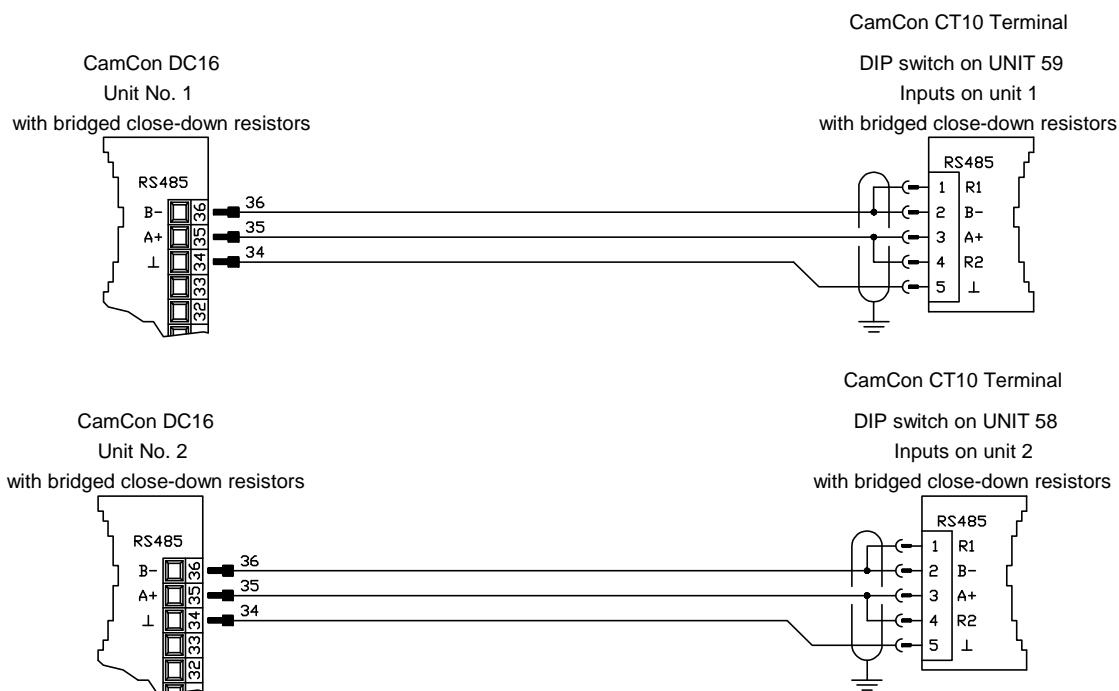

Please note: With an RS485 interface, the cable ends have to be switched with close-down resistors. For this purpose, CamCon CT10 Terminal is equipped with resistors on PINs 1 and 4, that have to be connected accordingly before the first activation. The close-down resistors may only be bridged at the beginning and the end of a linked network, since it would otherwise overload the RS485 interface and thus disrupt the communication.

Example: Linking 2 x CamCon DC16, 1 x CamCon CT10 Terminal and 1 x CamCon CD10 Display as well as a PC.

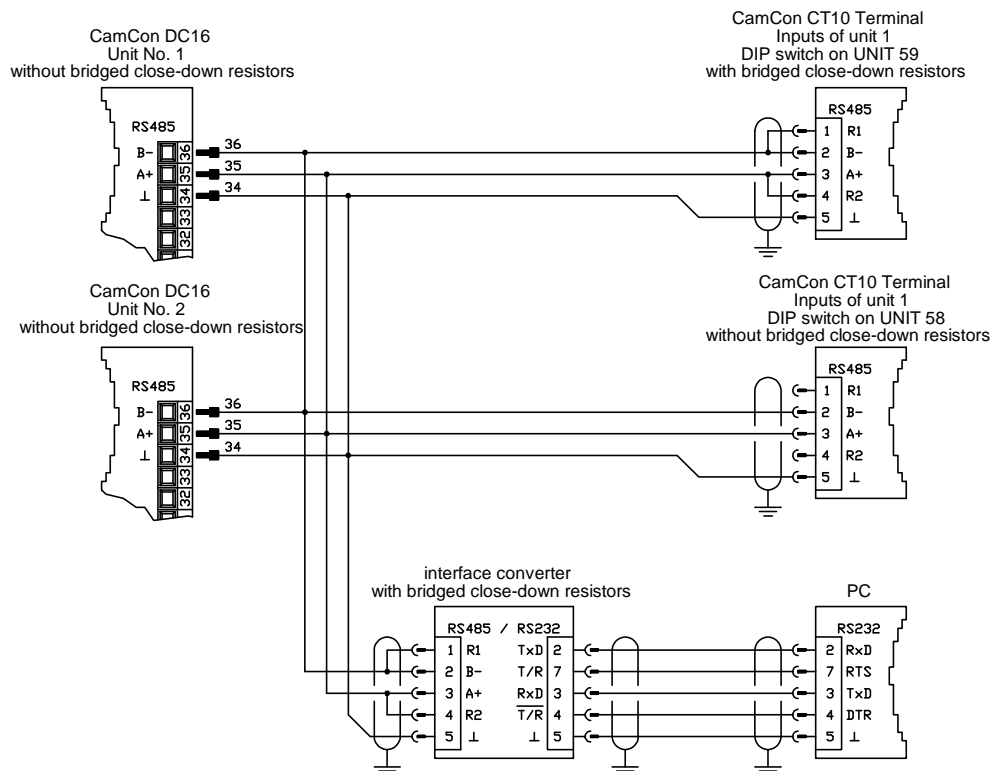

4. Setting the DIP switch

4.1. Setting the unit number with DIP switch 1 - 4

Via the DIP switch 1 - 4 on the back of the device, you can set the unit number of the CamCon CT10 Terminal. This is necessary for an exact identification on the RS485 - BUS. The base unit number of the CamCon CT10 Terminal is the number 59. The 4 DIP switches are then subtracted from the base number in binary code, resulting in the CamCon's unit number. If you e.g. switch DIP switches 1 and 3 to "ON", the resulting unit number is 54. This number may only be allocated to one device on the entire RS485 - BUS.

4.2. Setting the communication mode via DIP switch 5

If the DIP switch 5 is set to "ON", communication mode "**Multiuser**" or "**Standard**" is selected. The setting "OFF" of the DIP switch selects the communication mode "**Cam-Bus**".

Cam-Bus: Choose this setting, if you want to connect several CamCon CT10 Terminals or other CamCon devices via the RS485 BUS (e.g. programming device type: DC51/T4, CamCon CT10 Terminal and PC).

Please note: This communication mode requires an RS485 interface on all CamCon units and the PC, as well as with software from at least December 1996.

Multiuser / Standard: Contrary to the "**Cam-Bus**" mode, these modes do **not** support connections of several CamCon CT10 Terminals or the operation of an additional PC on the RS485 BUS.

4.3. Setting of DIP switch 6

This DIP switch must be set to "ON" at all times on a CamCon CT10 Terminal.

5. The inputs

The inputs of the CamCon CT10 Terminal are highly active and operate with 24Volt signals with an input resistance of about 5 KOhm. The inputs are not free of potential to the voltage supply of the device.

5.1. Inputs 1 - 4

The inputs 1 - 4 of the CamCon CT10 Terminal are used to set the unit number of the device with which you want to establish contact, with the use of a selector switch. The number is the binary code of these first 4 inputs. If e.g. outputs 1 and 3 are active (supplied with 24 Volt), the CamCon Terminal tries to establish contact with the device with unit number "5".

Please note: If 24 Volt is supplied to outputs 1,2,3 and 4, the unit search mode of the CT10 activates. See chapter 7.1. Device search mode on page 10.

5.2. Inputs 5 + 6

The inputs 5 and 6 of the CamCon CT10 Terminal may **not** be allocated.

6. Front view of the CamCon CT10 Terminal

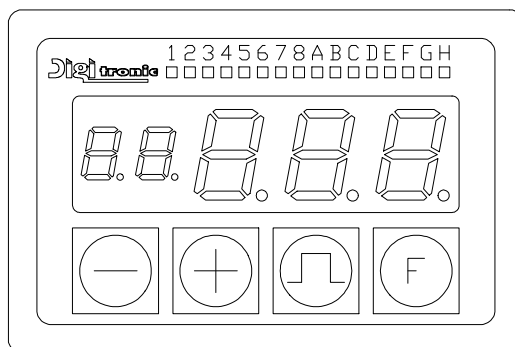

6.1. The LED output display

The output display shows, given contact to a CamCon cam controller was established, the current state of the first 16 outputs (outputs 1-8 and A-H = 9-16) or of outputs I-P = 17-24 and Q-X = 25-32. If an LED blinks, the corresponding output is active. You can switch through the display range with the + key. During the control of outputs I-P or I-X the display shows the message | - P (for outputs I-P) or | - X (for outputs I-X).

6.2. The seven-segment display

This display shows the system messages of the CT10 Terminal e.g. c E | or - | -. If contact with a CamCon cam controller was established, messages and program information are displayed here, e.g. the position, speed and error messages.

Note: During online operation you can display the current program number by pressing the  key, e.g. P.R. . . Q.

6.3. The keyboard

The foil keyboard of the CamCon is dirt and solvent resistant. The keys have a pressure point for tactile feedback.

See also chapter 8.2.17. Keyboard lock on page 16.

6.3.1. Outline of the key functions

 = This key increases the input values of programming or initialization by 1 during online operation. Keeping the key pressed for more than 2 seconds, starts the automatic increase of the input value with increasing speed.
To switch the output display during standard display. Here you can switch through the range of outputs displayed by the LEDs (only for units with more than 16 outputs).





Activates the unit search in the positive direction in the offline mode.

 = This key decreases the input values of programming or initialization by 1 during online operation. Keeping the key pressed for more than 2 seconds, starts the automatic decrease of the input value with increasing speed.
Keeping this key pressed (about 2 seconds) in the standard display, opens an outline of the system registers.

Activates the unit search in the negative direction in the offline mode.

 = Initiates the cam programming during online operation or to change the input type during cam programming.
Pressing the key in the standard display shows you the current program number.

 = During online operation, this key starts the initialization, the selection of the system registers during initialization or the display of the system register outline.
Keeping this key pressed in the standard display (for about 2 seconds) initiates the input for the programming of the speed compensation.

Note: If outputs 1 - 4 are supplied with 24 Volt and the keys  and  are each pressed twice during online operation, the CT10 switches to the offline mode. This is confirmed by the message  . Here you can now start the unit search.
See chapter 7.1. Device search mode on page 10.

7. Commissioning

Before the first activation of your device, please check the wiring.
See chapter 3. Pin allocation on page 5.

After activating the CamCon CT10 Terminal, it displays the text message $\square \square \square$ in the seven segment display. Afterwards it tries to establish contact with a CamCon cam controller. If the contact was established, the standard display of a CamCon DC40 cam controller is displayed, and you can start with programming and initialization.

If no unit was found to make contact with, the CamCon CT10 Terminal displays the number of the unit, which it was not able to contact. This is displayed with a negativ algebraic sign in front of and after the unit number (e.g. "-10-").

The CamCon CT10 Terminal always tries to establish contact with the device with the number that is binary encoded at inputs 1 to 4 of the terminal. However, if all four inputs are supplied with 24V, the automatic device search of the CamCon CT10 Terminal is activated.

7.1. Device search mode

In this mode, the CamCon CT10 Terminal automatically searches for a CamCon cam controller on the RS485 Bus.

Please note: This option is only available, if outputs 1 to 4 are all supplied with 24V.

When the voltage of the CamCon CT10 Terminal is activated, the Terminal tries to make contact with the CamCon cam controller, with which it had contact before its last deactivation. If this is not possible, the number of the cam controller is shown on the display (e.g. "-10-").

By pressing the keys $\square+$ or $\square-$, you can start the device search in the desired direction.

If the Terminal was able to establish contact with a CamCon cam controller upon activation, this contact has to be separated first. This is down by pressing the \square key twice and also pressing the \square key twice, afterwards. The online mode is then terminated, and the message $\square \square \square$ appears. At this point you have to start the device search mode by pressing either the $\square+$ or the $\square-$ key, because a failure to do so causes the CamCon CT10 Terminal to reestablish the contact with the cam controller it had contact with after about 5 seconds.

During a device search, the display shows the device number it searches for on the right side of the display, while the search itself is indicated by a moving segment on the left side..



If a CamCon cam controller is found, the display stops moving, and the unit number blinks for about 2 seconds.



Afterwards the standard display of the CamCon cam controller is displayed (position).



You can now start with the programming and the initialization.
Please see chapter 8. Programming on page 11.





8. Programming

The programming with the CamCon CT10 Terminal is compatible with the programming of a CamCon DC40 cam controller. You always start at the main menu (speed or position display) that is displayed when the CamCon CT10 Terminal has successfully established contact with the CamCon cam controller.

First you should start with the initialization of the system parameters to adjust the cam controller(s) to your machine(s). This process is described in the following chapters. After having successfully set the system parameters, the CamCon is fully operational and no further error messages should occur. You can now start with the actual cam programming.

8.1. General deletion

Follow the steps below to initiate a general deletion of a CamCon cam controller:

1. Enter the standard display of the CamCon.
2. Press the  4 times.
3. Press the  4 times.
4. Press the  key and hold it pressed (about 2 seconds) until the display shows `S. 360.`
5. Press the  key and hold it pressed (about 2 seconds) until the display shows `CLEAR.`
6. Release the  key.

After a short while, the standard display reappears. This time depends on the size of the EEPROM used, since the memory has to be formatted. Using a 32k - EEPROM the deletion process takes about 2 minutes. Afterwards, the general deletion is finished. All cams are deleted, and the system parameters have their standard values.







Attention: Deleted memory cannot be recovered.

8.2. Initialization of the system parameters

8.2.1. User keys for the system parameters

Follow the key sequence below to start the programming of the system parameters:

1. Press the  key 4 times.
2. Press the  key 4 times.
3. Press the  and hold it pressed (about 2 seconds) until the display shows `S. 360.`

To select the single parameters, just press the  key to switch forwards between them. This selection is possible only in increasing order. If you have skipped a parameter by a mistake, you have to leave the initialization and start the process all over again. The previously entered values are already accepted, though.

When you reach the last system register e.g. `AAUS 1` or `A2 = 10`, the initialization is completed by pressing the  key again, and you return to the standard display.

The initialization can be left at any time by pressing the  key, and any changes made up to this point will be saved and accepted as the new values.

8.2.2. The encoder resolution

The display $5. \ 360$ shows the encoder resolution in steps per rotation. As a standard the CamCon works with an encoder with a resolution of 360 steps per rotation. In this case you need not make any changes. Otherwise you can adjust the resolution value here to match your encoder using the keys \ominus and \oplus . Several fixed encoder resolutions can be selected, all values of common encoders: 256, 360, 512, 1000, 1024, 2048, 4096 and 8192 steps. If it is not possible to select values in the upper resolution range, you do not have enough memory. You have to extend the units memory in this case.

Attention: If the display shows $5 \square \square \square \square$, a special measuring system has been selected by the PC. In this case a change of the encoder resolution is only possible via the PC.



Caution! Keeping the \square key too pressed too long (during the display of the encoder resolution) initiates a general deletion!

8.2.3. The electronic gear

After pressing the \mathbb{F} the display shows e.g.: $\square. \ 360$. Here you set the effective (for the user visible) measuring range of the encoder. The electronic gear is a transformation of the measuring range. As a standard, a translation ratio of 1:1 is chosen, i.e. with a encoder resolution of 360 steps, this value is set to $\square. \ 360$. By pressing the keys \ominus or \oplus you can change the value of the translation.

Example: At one full rotation of an encoder with a resolution of 360 steps, the machine moves 1000mm. After setting the electronic gear value to $\square. \ 1000$, the display is no longer shown in angular degrees, but in mm. The display will not change in steps of 1 however, because the resolution of the encoder remains unaffected..

If you select e.g. $\square. \ 100$, the actual value is calculated down to a range of 100, and the position display is then made in cm. A floating comma display is not possible.

8.2.4. The actual position hysteresis

By pressing the \mathbb{F} key the display shows $h4. \ \square$. This value is needed to suppress the flashing of the outputs with an unsteady collection of the actual value. The exact value can only be determined through experiments, though it should be as small as possible or always 0. Using the keys \ominus and \oplus you can set the value for the hysteresis between 0 and 1/4 of the total resolution. The hysteresis can be 255 impulses at most.

8.2.5. Measuring system control

By pressing the **F** the display shows $\frac{!}{!}$. This value is needed to prevent the maximum speed for measuring system control (Impulses per cycle) The value to be entered is calculated from the actual cycle time of the CamCon, from the physical solution of the measuring systems and the speed of the machine.

Note: The resolution must be set as a physical value. If e.g. a measuring system with 4096 impulses is set and the displayed value is transformed to 3600 impulses by the gear, you must set the "resolution"-value of the formula to 4096.

Example: Cycle time = 0.5ms / solution = 360 / speed of the machine = 180 min⁻¹.

$$\text{Value} = \frac{\text{Resolution} * \text{machine speed}}{60 * 1000} * \text{cycle time} + \text{safety reserve}$$

$$\frac{360 * 180}{60 * 1000} * 0.5 + 5 = 5.54 \approx 6$$

The result is rounded up and entered. If the CamCon now registers an actual value jump of more than 6 impulses, an error message "**Pos-Err:5**" is created.

If a zero is entered, the control is switched off. The maximum value is 9999 impulses.

8.2.6. Reversing the rotation direction

By pressing the **F** key the display shows $\Gamma | \square | \text{h} | \square$. The display $\Gamma | \square | \text{h} | \square$ shows that the encoder is counting clockwards (regarding the wave). By pressing the keys **-** and **+**, you can reverse the rotation direction of the encoder. The display then shows $\Gamma | \square | \text{h} | |$.

8.2.7. Correction of the zero point

By pressing the **F** key the display shows e.g.: $\square \ 123$, the current angular position of the encoder. After having set the electronic gear to a mechanical "0", you can also adjust the current angular position to "0" with keys **-** and **+**, so that the mechanical and the electrical zero point correspond to each other. The display now shows $\square \ \square$.

8.2.8. The speed factor

After pressing the **F** key the display shows e.g.: $\square \ 0.166$. This is the factor for calculation of the speed. Using keys **-** and **+** you can set this value from 0.000 to 9.999.

Normally the speed is displayed in increments (or impulses) per second. If you want to display the speed in e.g. rotation / minute or in pieces / minute (hour), you have to enter a value in this system register for calculation of the speed value in the new measurement. This factor is multiplied with the normal speed value, and then the result is displayed.

Example 1: A rotatory encoder with 512 steps supplies 512 increments per minute, meaning the gear runs with 1 rotation per minute. The CamCon measures $512/60 = 8,533$ increments per second.
To have the speed displayed in rotations per minute you have to enter the corresponding factor of $1/8.533 = 0.117$.

Example 2: An encoder with 360 steps supplies 360 increments per minute, i.e. the gear runs with 1 rotation / minute. The CamCon measures $360/60 = 6$ increments per second.
To have the speed displayed in rotations / minute, you have to enter a speed factor of $1/6 = 0,166$ eingeben.

8.2.9. Adjusting the speed display

By pressing the **F** key, the display shows e.g.: $\square \ \square \ \square \ \square$. Here you enter the maximum rotation of the electronic gear or the speed of the movement. This input is used to adjust the speed display. By pressing the keys **-** and **+**, you can set this value between 0 and 9999. The CamCon uses this value to determine the point for automatically switching from the position display to the speed display. This is always at 5% of the value of this system register, e.g. for 1000 rotations/min at 50 rotations/min.

If your device is equipped with an analog output emitting an analog signal proportional to the speed, this value must also be noted for the calculation of the maximum output voltage. An input of e.g. 1000 rotations/min here means, that, at +/-1000 rotations/min, the analog output voltage reaches its maximum value (100%) of +/-10V.

8.2.10. Accuracy of the speed display

By pressing the **F** key, the display shows e.g.: $\square \ \square \ \square$. During operation the speed display usually fluctuates by a certain amount. These fluctuation find their reasons in the measuring principles, as it is a scanning measuring system. In this system register you enter a value for calming the speed display, i.e. you initiate a kind of averaging process. The smaller this value, the calmer the speed display will become. You have to find an individual compromise between the accuracy and a comfortable reading of the speed display. Using keys **-** and **+**, this value can be set between 0.01 and 9.99.

8.2.11. Display type

By pressing the **F** key, the display shows e.g.: **d.A u t**. If you do not want the automatic change to the speed display at 5% of the speed adjustment value, you can choose between three different display types with the keys **-** and **+** in this system register.

d.A u t The display automatically switches from position to speed at 5% of the speed adjustment value.
d.S P E E. Only the current speed is shown on the display.
d. P o S. Only the current position is shown on the display.

By pressing the **F** key, the display shows e.g.: **d E.** **□**. In this system register you can declare an input with which you can switch between position and speed display. Choose the desired input number using keys **-** and **+**. However, this option is only available, if the display type is set to **d.S P E E.** or **d. P o S.**. Supplying the input with a signal changes to the position display at the original setting of **d.S P E E.** or to a change to the speed display with a setting of **d. P o S.**. If no inputs are available, an input here is not possible.

8.2.12. Setting the cable length of the encoder

By pressing the **F** key, the display shows e.g.: **L** **3** **□**. Here you have to enter the length of the cable between the CamCon and the encoder in meters using the **-** and the **+**. This is necessary, because the cable length determines the maximum possible speed of serial data transfer. The larger the entered cable length, the larger the cycle time becomes, and the data traffic becomes slower. The maximum value for the cable length is 1000m.



Attention: *If your cable is more than 300m long, you have to use a special encoder !*

8.2.13. Setting the cycle time

By pressing the **F** key, the display shows **□ H.**. This display means you are operating with the shortest possible cycle time. Using keys **-** and **+**, you can modify this time value, e.g. when longer single speed compensation are needed for the programming of a large number of outputs with speed compensation or with a high encoder resolution. These single speed compensation depend on the available memory and the cycle time. However, you will only notice a change, when the entered value is larger than the current cycle time.

8.2.14. Number of inputs

By pressing the **F** key, the display shows e.g.: **E 16**. This display shows the number of inputs of the cam controller. Using keys **-** and **+** you can in- or decrease this value. You can manage up to 16 inputs.

8.2.15. Number of outputs

By pressing the **F** key, the display shows e.g.: **A 24**. This shows the total number of outputs of the cam controller. This value can be raised or lowered using the **-** and **+** keys. You can manage 8,16,24 or 32 outputs.

8.2.16. Number of outputs with speed compensation

By pressing the **F** key, the display shows e.g.: **E A 24**. This shows the number of outputs with speed compensation of the cam controller. You can increase or decrease this value with the keys **-** and **+**.

8.2.17. Keyboard lock

By pressing the **F** key, the display shows e.g.: **L 0**. Here you have the possibility to define one input that locks the keyboard to prevent unauthorized operation. Select the input for the keyboard lock using the keys **-** and **+**. A zero in this input field prevents the keyboard lock. If no inputs are available, this option is not possible.

8.2.18. Input for error reset

With the positive edge (+24V DC) on this input e.g.: **E 9 0**, the CamCon resets an Pos-Err:1,2,3 and 5 but **not** an "Out-Error".

8.2.19. Enable input

By pressing the **F** key, the display shows e.g.: **E 1 0**. Here you may define an input that lock or unlock and/or enable the outputs. A signal of +24V DC on this input enable the cam output, a signal of 0V lock and/or disenable the outputs. If the input number is "0", this function is switch off and the outputs are always enabled.

8.2.20. Setting the external program selection

By pressing the **F** key, the display shows e.g.: **|| 1**. Here you can select the number of programs that can be selected externally. Select this number with keys **-** and **+**. With the CamCon CT10 Terminal you can manage up to 999 programs.

Press the **F** key again, and e.g. **|| E 0** appears on the display. In this system register you have to define an input that becomes the take over impulse. The input you select here has to be chosen, so that you still have enough free inputs for the signal of the program number. The program number is then sent to the inputs after the input for the take over impulse as a binary number. The least situated bit is the input after the take over impulse. This makes the position of the inputs for the program selection variable. Using keys **-** and **+** you can now enter the desired input number, if enough inputs are available. Otherwise this option is not possible.

8.2.21. Actual position preset or external shifting of the zero point

By pressing the **F** key, the display shows e.g.: **P** **0**. This system register allows you to set the actual position to a new value (preset) via the signal at an input. By setting the preset to zero, you can create an external zero point signal, to e.g. synchronize the position of the machine with the actual position of the CamCon cam controller. You can set the desired preset value with the **-** and **+** key. When you have entered the preset you move to the input of the input number that triggers the preset by pressing the **F** key. The display now shows e.g.: **P** **E** **0**. Using keys **-** and **+** you can now set the desired input number. If no inputs are available, this option is not possible. By pressing the **F** key again, you enter the input of the preset type. The display now shows e.g.: **P** **U** **0**. Using the keys **-** and **+**, you choose between the two preset types:

P **U** **0** **A**.

"RAM" storage.

The preset is only copied into the RAM memory of the device. After a deactivation, the actual position preset is lost.

P **U** **0** **E**.

"EEPROM" storage.

The preset is copied into both the RAM and the EEPROM memory, making the values safe from supply voltage failure.

Attention: *The storage into the EEPROM memory should only be used, if the preset trigger does not appear very frequently and is absolutely necessary. This is because an EEPROM only has a limited number of writing cycles (100000). Exceeding this maximum number of writing cycles causes the destruction of the EEPROM and a loss of all programming data of the CamCon.*

8.2.22. The security or SI output

To be able to monitor the CamCon even during e.g. short circuits on the output channels or errors in the position measurement, you can program a full cam on a single output, i.e. this output is active for all angular positions. Press the **F** key, and the display shows the message **S** **0**. Select an input number with the keys **-** and **+**. This input will function as an SI output. A zero in this input field means, that no security output was programmed.

Note: The SI output will be reset during a program change.

8.2.23. The rotation direction or FR output

By pressing the **F** key, the display shows e.g.: **FR** **0**. Here you have the possibility to display the rotation direction of the encoder on an output. Using the keys **-** and **+** you can select an output, that is active during a positive rotation direction and deactivates during negative encoder movement. A zero in this input field means no FR (forward-reverse) output was declared. (see also chapter 8.2.25. The speed hysteresis on page 18)

8.2.24. The stand still or V0 output

By pressing the **F** key, the display shows e.g.: **11 0 0**. Here you can define an output that is active during movement of the encoder and deactivates during encoder standstill. Select the desired output with the **-** and **+** keys. A zero in this input field means no V0 output has been programmed. See also chapter 8.2.25. The speed hysteresis below.

8.2.25. The speed hysteresis

You have to define the hysteresis in order to use the monitoring options for the encoder standstill and the rotation direction correctly. This value is needed to suppress the flashing of the outputs at small changes in speed. The exact value can only be determined through experiments, though it should be as small as possible.

By pressing the **F** key, the display shows e.g.: **0 H 4**. Select the value for the hysteresis using keys **-** and **+**.

8.2.26. Setup of the serial interface

The upgrade of the CamCon with the option of communication via the L1 Bus of the S5 PLC controls also led to an upgrade of functions of the CamCon. By pressing the **F** key, the display shows e.g.: **S E A N D**. Using the **-** and the **+** key you can choose between the four different communication modes.

Please note: chapter 3. Pin allocation on page 5 and chapter 8.2.27. Setting the unit number on page 19.

C - B U S = Cam-BUS: Choose this setting, if you need to program or display one or several CamCon units with different devices via an RS485 interface (e.g. CT10 and PC).

Attention: In the Cam-BUS mode, **all** CamCon units and the PC have to be equipped with an RS485 interface and software from at least August 1996.

S E A N D = Standard: The standard operation is a point to point communication, i.e. you can only connect 2 devices (CT10 to a DC16). Since no protocol security is used in this mode, its use is only permitted for testing purposes.

M U L T I = Multiuser: This mode only operates with an RS485 interface. Contrary to the "Cam-BUS" mode it is **not** possible to use several programming devices (e.g. CamCon Terminal CT10 and a PC) on the RS485 BUS.

S 5 - L 1 = S5-L1: This setting enables a connection of a Siemens S5 PLC with L1 BUS to the CamCon. You will find more information about this option in the corresponding handbook.

3 9 6 4 r = 3964r: This setting is necessary, if you want to program the CamCon device via the serial interface with an RK512 procedure. This is a so-called point to point communication. A manual with the order No. H-RK512e is available for this procedure.

Attention: The CamCon CT10 Terminal does not support the S5-L1 and 3964r mode at this time. Because of this, the "S5-L1" and "3964r" mode may not be selected, since this would make the communication to the CamCon cam controller impossible.

See also chapter 4.2. Setting the communication mode via DIP switch 5 on page 7.

8.2.27. Setting the unit number

In the Cam-BUS, Multiuser and S5-L1 operation, the input of a unit number is needed for distinguishing the devices. By pressing the **F** key, the display shows e.g.: $\square \square \square . \square$. Select a number between 0 and 63 using keys **-** and **+**. Every unit number may only be allocated once. This makes it necessary to separately set unit number and communication mode for each device before a connection of the serial interfaces.

8.2.28. Setting the programming mode

By pressing the **F** key, the display shows e.g.: $P \square \square \square \square$. In this system register you select the mode for cam programming. Using the keys **-** and **+** you can change from programming mode 0 to programming mode 1. Operation in programming mode 1 is easier than operation in programming mode 0, but it is not possible to program several cams on a single output in programming mode 1.

8.2.29. Releasing the analog outputs

By pressing the **F** key, the display shows e.g.: $A A U S |$. In this system register you enable the analog outputs. Use the **-** key or the **+** key to choose between a 0 and a 1.

Note: The three following chapters concerning the matching of the analog outputs are only relevant, if you chose setting 1, and if your device is equipped with such outputs.

8.2.29.1. Offset match for analog output 1

By pressing the **F** key, the display shows $A | = \square$. In this system register you can match the zero point of analog output 1. Connect a voltage measure to analog output 1, and correct the output voltage with keys **-** and **+** until the measuring device shows 0V.

8.2.29.2. Amplification match for analog output 1

By pressing the **F** key, the display shows: $A | = | \square$. Here you can set or match the amplification factor of analog output 1. The maximum analog output voltage is $\pm 10V$. If you desire a smaller voltage range, adjust the maximum current with keys **-** and **+**. The CamCon emits in this setting the maximum positive output voltage. Connect a voltage meter to analog output 1 and correct the output amplification until the measuring device shows the desired maximum voltage.

Please note: An adjustment of the speed display via the amplification match is not recommendable !
See chapter 8.2.9. Adjusting the speed display.

8.2.29.3. Matching analog output 2

After pressing the **F** key again, the display moves to analog output 2. The match for the zero point and the amplification factor is the same as for analog output 1 (see above).

8.3. Speed compensation

By keeping the **F** key pressed (for about 2 seconds) in the standard mode, the display shows **E 1.** **0**. Here you enter the speed compensation for output 1 in the range from 0ms to 999ms. Using keys **-** and **+** you can change this value in steps of 1ms. With every short pressing of the **F** key, the programming of the speed compensation moves to the next output. The display shows **E 2.** **0**, ... This way you enter time factors for each output, to (de)activate the outputs earlier. If you have already defined an output as a special output, you cannot enter a speed compensation for this channel. By pressing the **□** key, you can leave the programming of the speed compensation at any time.

8.4. Cam programming in programming mode 0

8.4.1. Program selection

The cam programming and the program selection are initiated as follows:

Keep the **□** key pressed (for about 2 seconds), until the display shows e.g.: **P 0** **0**. This shows the currently selected program (in our example program 0). Using keys **-** and **+** you can now enter a program number in the range from 0 to 999. Confirm your chosen program number and leave the cam programming mode by pressing the **F** key.

You can control the current program number by pressing the **□** key. The display shows e.g.: **P 0** **.** **.** **0**.

8.4.2. Output selection

Press the **□** key during program selection. The display shows e.g. **1** **0** **-** **-** **-**. This shows that no cams were programmed on output 1 in the output selection mode. Using keys **-** and **+** you can now select an output on which you want to program a cam. Automatic in- or decrease is not possible with the selection of the outputs. If you have already defined an output as a special output, you cannot enter a speed compensation for this channel.







8.4.3. Cam search



By pressing the **□** key, you leave the 'output selection' mode **1** **0** **-** **-** **-** and enter the 'cam search' mode **1** **0** **-** **-** **-**. In the cam search mode **1** **0** **-** **-** **-** you can search for cam activation points by pressing the **+** key. Every time you press the **+** key, CamCon searches the memory for the activation points of other cams on this output. If no cam was programmed, the display shows **1** **0** **-** **-** **-**.

8.4.4. Base value











By pressing the **□** key, you leave the 'cam search' mode **1** **0** **-** **-** **-** and enter the 'base value' mode **1** **1** **1** **0**. You can now select a desired value with the keys **-** and **+**, e.g. 100. This is the base value, from which cams are created or deleted by changing the position of the (de)activation points.





8.4.5. Changing the activation point

By pressing the  key, you move from the 'base value' mode | 1 1 1  to the 'activation point' mode |  . Using keys  and  you can move the activation point in steps of one. This is done after the following system:

Press the  key, and at the previously displayed base value ,e.g. 100, the switching point is deleted, and afterwards the base value is raised by 1 to 101. If you press the  key, the base value, 100, is reduced by 1, and the new activation point has the position 99.

8.4.6. Changing the deactivation point

Press the  key again, leave the 'activation point' mode |   and enter the 'deactivation point' mode |  . CamCon first searches for the deactivation point of the current cam (e.g.: |  |  ). Using keys  and  you can change this value in steps of one. This is done after the following system:

Press the  key, and at the previously displayed base value ,e.g. 100, the switching point is deleted, and afterwards the base value is raised by 1 to 101. If you press the  key, the base value, 100, is reduced by 1, and the new deactivation point has the position 99. Please note that it is not possible to decrease the deactivation point below the value of the activation point. Press the  key to return to the 'output selection' mode |  . _ _ _ .

8.4.7. Exit cam programming

No matter in which programming mode you are currently in, you can exit cam programming at any time by pressing the  key. You then return to the standard display.













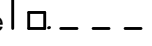

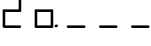

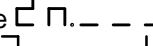
8.4.8. Examples for cam programming in programming mode 0

8.4.8.1. First cam programming

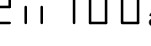
Task:

After a general deletion of the program memory and a successful system initialization, program a cam in program 0 on output 2, ranging from 100 to 200.

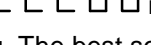

Solution:

1. Keep the  key pressed (for about 2 seconds), until you enter the 'program selection' mode .
2. Press the  key, you are now in the 'programming' mode .
3. Press the  key to select output 2 .
4. Press the  key to enter the 'cam search' mode .
5. Press the  key for the input of the base value .
6. Press the  key, and keep it pressed until  appears on the display.
7. If you let go of the  key too soon or too late, correct the value to 100 using keys  and .
8. Press the  key. The activation point is shown.
9. Press the  key to program the deactivation point of the cam.
10. Press the  key, and keep it pressed until  is displayed.

ATTENTION! The key may not be held too long. The best solution is to hold the  key pressed until 190 and move up to 200 in steps of one.

11. Press the  key. The standard display reappears.

NOTE:













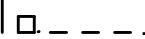

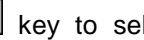

The programming of the (de)activation points is made "Online", meaning that if you keep the  key pressed too long, the cam itself is too long. You can correct this with the  key but the range that you move backwards to the desired deactivation point is deleted. Previously programmed cams in this range are then lost.

8.4.8.2. Programming additional cams on the same output

Task:

Program a cam in program 0 on output 2 from 300 to 330, in addition to the previously programmed cam (100 to 200).

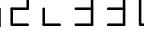

Solution:

1. Keep the  key pressed (for about 2 seconds), until you enter the program selection mode .
2. Press the  key, and enter the programming mode .
3. Press the  key to select output 2 . The activation point of the previously programmed cam is displayed.
4. Press the  key to enter the cam search mode .
5. Press the  key to enter the base value .
6. Press the  key and keep it pressed until  is displayed.
7. If you let go of the  key too soon or too late, correct the value to 300 using keys  and .
8. Press the  key. The activation point is displayed.
9. Press the  key for the programming of the deactivation point.
10. Press the  key, and keep it pressed until  is displayed.

ATTENTION! The key may not be held too long. The best solution is to hold the  key pressed until 320 and move up to 330 in steps of one.

11. Press the  key. The standard display reappears.

NOTE:













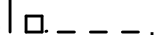

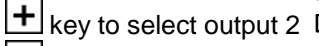
The programming of the (de)activation points is made "Online", meaning that if you keep the  key pressed too long, the cam itself is too long. You can correct this with the  key but the range that you move backwards to the desired deactivation point is deleted. Previously programmed cams in this range are then lost.

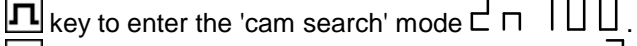
8.4.8.3. Deletion of a particular cam

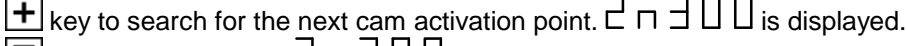
Task:

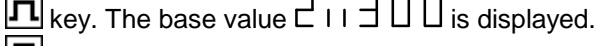
Delete the cam from 300 to 330 in program 0 on output 2.

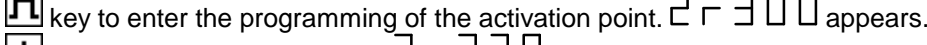
Solution:

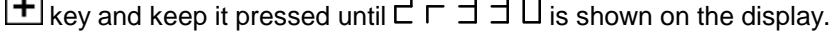
1. Keep the  key pressed (for about 2 seconds), until you enter the 'program selection' mode .
2. Press the  key to enter the 'programming' mode .
3. Press the  key to select output 2 . The first cam activation point is displayed.
4. Press the  key to enter the 'cam search' mode .
5. Press the  key to search for the next cam activation point.  is displayed.
6. Press the  key. The base value  is displayed.
7. Press the  key to enter the programming of the activation point.  appears.
8. Press the  key and keep it pressed until  is shown on the display.

ATTENTION! The key may not be pressed too long. It is best to keep the  key pressed until 320 and then move to 330 in steps of one.





9. Press the  key to return to the standard display.

NOTE: The programmed cam is deleted by moving the cam activation point to the cam deactivation point. By moving the cam activation point beyond the deactivation point, you also delete that range after the cam (e.g. from 330 to 350). Cams programmed in this area are also deleted. Moving the wrong activation point now back to the originally desired position of 330, you create a new cam from 330 to 350 !

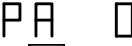

8.5. Cam programming in programming mode 1

8.5.1. Program selection



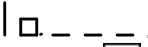

The cam programming and the program selection are initiated as follows:



Keep the  key pressed (for about 2 seconds), until the display shows e.g.: . This shows the currently selected program (in our example program 0). Using keys  and  you can now enter a program number in the range from 0 to 999. Confirm your chosen program number and leave the cam programming mode by pressing the  key.

8.5.2. Output selection

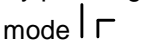





Press the  key during program selection. The display shows e.g. . This shows that no cams were programmed on output 1 in the output selection mode. Using keys  and  you can now select an output on which you want to program a cam.



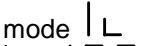

8.5.3. Changing the activation point

By pressing the  key, you move from the 'output selection' mode  to the 'activation point' mode . Using keys  and  you can move the activation point in steps of one. This is done after the following system:

Press the  key, and at the previously displayed base value ,e.g. 100, the switching point is deleted, and afterwards the base value is raised by 1 to 101. If you press the  key, the base value, 100, is reduced by 1, and the new activation point has the position 99.

8.5.4. Changing the deactivation point

Press the  key again, leave the 'activation point' mode  and enter the 'deactivation point' mode . CamCon first searches for the deactivation point of the current cam (e.g.: ). Using keys  and  you can change this value in steps of one. This is done after the following system:

Press the  key, and at the previously displayed base value ,e.g. 100, the switching point is deleted, and afterwards the base value is raised by 1 to 101. If you press the  key, the base value, 100, is reduced by 1, and the new deactivation point has the position 99. Please note that it is not possible to decrease the deactivation point below the value of the activation point. Press the  key to return to the 'output selection' mode .

8.5.5. Exit cam programming

No matter in which programming mode you are currently in, you can exit cam programming at any time by pressing the  key. You then return to the standard display.













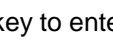

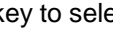

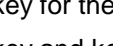

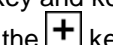
8.5.6. Examples for cam programming in programming mode 1

8.5.6.1. Cam programming

Task:

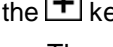
After a general deletion of the program memory and a successful system initialization, program a cam in program 0 on output 2, ranging from 100 to 200.

Solution:











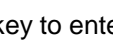

1. Keep the  key pressed (for about 2 seconds), until you enter the program selection mode .
2. Press the  key to enter the 'programming' mode | .
3. Press the  key to select output 2 .
4. Press the  key for the programming of the activation point .
5. Press the  key and keep it pressed until  is displayed.
6. If you let go of the  key too soon or too late, correct the value to 100 using keys  and .
7. Press the  key for the programming of the deactivation point.
8. Press the  key and keep it pressed until  is displayed.
9. If you let go of the  key too soon or too late, correct the value to 200 using keys  and .
10. Press the  key. The standard display reappears.

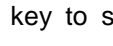
8.5.6.2. Cam deletion

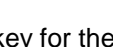
Task:

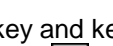
Delete the cam from 100 to 200 in Programm 0 on output 2.

Solution:

1. Keep the  key pressed (for about 2 seconds) until you are in the program selection mode .
2. Press the  key to enter the 'programming' mode | .
3. Press the  key to select output 2 . The cam activation point is found and displayed.
4. Press the  key for the programming of the activation point.  appears.
5. Press the  key and keep it pressed until  is displayed.
6. If you let go of the  key too early, move to 200 with the  key. If you let go of the  key too late, do not correct it ! The cam is already deleted. Moving the activation point backwards will create a new cam that will have to be deleted.
7. Press the  key to return to the standard display.

8.6. Outline of operations



8.6.1. Change of the output display

Press the **+** key | - || Display of the output channels I-X











8.6.2. Initialization of the system registers

		33	Standard display position/speed
Press the - key 4 times		33	User key for system registers
Press the + key 4 times		-	User key for system registers
Press the F key (about 2 sec)	S.	360	Encoder resolution physically
Press the F key	G.	360	Encoder resolution desired
Press the F key	h4.	0	Actual position hysteresis
Press the F key	r c h	0	Encoder rotation direction change
Press the F key	0	123	Zero point correction
Press the F key	!! 0.	166	Speed factor
Press the F key		1000	Range adjustment of the speed display
Press the F key		100'	Accuracy of the speed display
Press the F key	dA u t	0	Display type
Press the F key	dE.	0	Input of the display type change
Press the F key	L	30	Encoder cable length of the SSI interface
Press the F key		04.	Cycle time
Press the F key	E	8	Number of inputs
Press the F key	A	32	Number of outputs
Press the F key	tA	24	Number of outputs with speed compensation
Press the F key	rL	0	Input for the keyboard lock
Press the F key	E9.	0	Input for error reset
Press the F key	E1.	0	Enable input for the outputs
Press the F key	!!	128	Number of inputs for the external program selection
Press the F key	!!E	1	Take over input for the external program selection
Press the F key	P.	0	Value for the actual position preset
Press the F key	PE.	0	Input for triggering the actual position preset
Press the F key	Pr4.r	A	Storage of the actual position preset
Press the F key	SI	0	Security output
Press the F key	!!r	0	Rotation direction output
Press the F key	!!0	0	Standstill output
Press the F key		0H4	Speed hysteresis
Press the F key	C - b	U5	Communication protocol of the serial interface
Press the F key	G n r.	10	Device number
Press the F key	P t y P	0	Programming mode
Press the F key	AAUS.	1	Releasing the analog outputs
Press the F key		33	Return to the standard display







































8.6.3. Speed compensation programming

		3 3	Standard display
Press the  key (about 2 sec)	1	0	Speed compensation for output 1
Press the  key and so on...	2	0	Switching forward to output 2
Press the  key		3 3	Return to the standard display

8.6.4. Cam programming

		3 3	Standard display
Press the  key (about 2 sec)	P A	0	Program selection
Press the  key	1 0	0	Output selection
Press the  key	1 0	0	Cam search for activation point (only mode 0)
Press the  key	1 1	0	Basic value position (only mode 0)
Press the  key	1 0	0	Move activation point
Press the  key	1 2	0	Search for and move deactivation point
Press the  key	1 0	0	Output selection
Press the  key	2 3	0	Select next output
Press the  key	1 0	0	Select previous output
Press the  key		3 3	Return to the standard display

8.6.5. Display the unit configuration

		33	Standard display position/speed
Hold the  key (2 sec)		10.0 1.4	Software version (Date 10.01.94 or 04)
Press the  key	F.	148	Number of free cams
Press the  key	E.	999	Maximum possible speed compensation in ms
Press the  key	r.	32H	Size of the RAM in kByte
Press the  key	S.	2H	Size of the serial EPROM in kByte
Press the  key	E.	0H	Size of the parallel EEPROM in kByte
Press the  key	S.	360	Encoder resolution physically
Press the  key	G.	360	Encoder resolution desired.
Press the  key	h y.	0	Actual position hysteresis
Press the  key	r i c h	0	Encoder rotation direction change
Press the  key	u 0.	166	Speed factor
Press the  key		1000	Range adjustment of the speed display
Press the  key		1001	Accuracy of the speed display
Press the  key	d A u t o		Display type
Press the  key	d E.	0	Input for the display change
Press the  key	L	30	Encoder cable length of the SSI interface
Press the  key		1824	Cycle time in μ s
Press the  key	E	8	Number of inputs
Press the  key	A	32	Number of outputs
Press the  key	E A	24	Number of outputs with speed compensation
Press the  key	r L	0	Input for the keyboard lock
Press the  key	E 9.	0	Input for error reset
Press the  key	E I.	0	Enable input for the outputs
Press the  key	11	128	Number of inputs for the external program selection
Press the  key	11 E	1	Take over input for the external program selection
Press the  key	P.	0	Value for the actual position preset
Press the  key	P E.	0	Input for triggering the actual position preset
Press the  key	P r y. r A		Storage of the actual position preset
Press the  key	S I	0	Security output
Press the  key	u r	0	Rotation direction output
Press the  key	u 0	0	Standstill output
Press the  key		0H9	Speed hysteresis
Press the  key	C - b u s		Communication protocol of the serial interface
Press the  key	G r.	10	Unit number
Press the  key	o P.	0	Options
Press the  key	P E y P O		Programming mode
Press the  key	A A U S.	1	Releasing the analog outputs
Press the  key		33	Return to the standard display

9. Troubleshooting

...

9.1. Problem: The display remains dark after activation

Possible cause:

The wiring is probably not correct.

Solution:

Check the wiring.

9.2. Problem: The display shows: EE.Err

Possible cause:

The EEPROM's data was erased or damaged by malfunctions. One of the present data storage medias (EEPROM or EPROM) was renewed or is defect.

Solution:

By pressing the key, all data is erased. During the deletion process the display shows CLEAR. Please contact your customer's service.

9.3. Problem: The display shows: I.Err 1

Possible cause:

The encoder is connected incorrectly.

Solution:

Check the wiring to the encoder, concerning the manual. When the error is corrected, press the key to clear the error message.

9.4. Problem: The display shows: I.Err 2

Possible cause:

The encoder is not connected or connected incorrectly

Solution:

Check the wiring to the encoder or the input of the encoders resolution. Regard also the encoder's manual. When the error is corrected, press the key to clear the error message.

9.5. Problem: The display shows: I.Err 3

Possible cause:

The encoder resolution of the connected encoder is not the encoder resolution set at the device.

Solution:

Check the input of the encoder resolution and the set cable length. Regard also the encoder's manual. When the error is corrected, press the key to clear the error message.

9.6. Problem: The display shows: I.Err 5

Possible cause:

Measuring system control has triggered. The CamCon detected an inadmissible step of the actual value. The measuring system is possibly wrong.

Solution:

Test the input of the measuring system's preset and the set cable length, or increase the admissible actual value steps. See also chapter "8.2.5. Measuring system control" on page 13 and regard the measuring system's manual. When the error is corrected, press the key to clear the error message.

9.7. Problem: An error happens during operation.

The display shows: I.Err 1, I.Err 2, I.Err 3 or I.Err 5.

Possible cause:

The encoder's connection cable or the encoder itself is defect. A cable without shielding or twin wiring was used. Also the position of the connection cable, e.g. next to a strong electro-magnetic interference point (e.g. high-voltage cable, motor-cable) can cause an I-Error.

Solution:

Check the encoder's wiring or the change the encoder device. Build up covers or lay the connection-cable elsewhere. Please also regard the encoders manual.

When the error is corrected, press the  key to clear the error message.

9.8. Problem : The display shows: A-Err

Possible cause:

Your outputs are overloaded or have short circuited. Check the wiring and connected power, as well as possible inductive loads that are operated without a free wheel or a deletion unit.

The number of entered inputs is not correct.

At an external interface module (e.g. DC91/IO or DC16/IO) the power supply failed.

Solution:

Check the wiring and the connection-cable as well as possible inductive loads, which are run without a free wheel or a deletion unit.

See chapter 8.2.15. Number of outputs on page 16.

See chapter 8.2.14. Number of inputs on page 16.

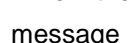
When the error is corrected, press the  key to clear the error message. During this time the message  appears for a short time. CamCon tries to reset the outputs during this time.

Attention: *Unfavourable cable routing can lead to the deactivation of the outputs, since it builds up a potential that is redirected into the outputs at the closing of a contact. With induced loads the outputs have to be switched with a freewheeling diode. Covers or inductivities very close to the device inside the switchboard have to be switched with a deletion unit as do those that are wired to or influence the wiring of the device.*



9.9. Problem: Outputs do not react

Possible cause:

An error message is displayed.

No power supply is connected to the outputs.

The enable input is not active.

The control - inputs of the CamCon are locked by an S5 or an S5L1 respective 3964r interface.

Solution:

Check the displayed error-message.

Connect the power supply.

Enable the Outputs with the enable input, see also chapter 8.2.19. Enable input on page 16

Un-lock the control-inputs.

See also the S5-L1-coupling's manual.

9.10. Problem : The display shows: t1.Err

Possible cause:

Every change in the system setting influences the available memory. Your changes of the system parameters (e.g. increasing the encoder resolution) have shifted an already programmed speed compensation above the memory range. At every further pressing of a key, the display shows output numbers concerned.

Solution:

This error can be recovered by changing the corresponding speed compensation or increasing the cycle time.

Please also regard chapter 8.6.5. Display the unit configuration on page 29.

9.11. Problem : The display shows: E.Full

Possible cause:

Too little memory in the EEPROM available for cam programming

Solution:

Please contact your customer service. Also, read the chapter 8.6.5. Display the unit configuration on page 29.

10. Technical data

Display	5 digit 7-seg. display + 16 LED for output states
Inputs	6 x 24V high active about 5KOhm.
Number of the displayed CamCon.....	via the inputs binary coded
Interface.....	RS485 up to 1000m.
Supply voltage.....	24V DC $\pm 20\%$
Current absorbtion	50mA.
Connections for:	
Interface.....	via D-SuB 9
Voltage supply.....	via plug block pins
Dimensions	(see chapter 2. Dimensions on page 5)
Arbeitstemperatur	0°C ... + 55° C
Normencasement after DIN 43700.....	72 x 48 x 82.5mm (LxHxD)
Weight.....	about 150g

11. Key word table

Activation point, Moving	21
Actual position preset.....	17
Amplification match for the analog outputs.....	19
Analog outputs, Releasing.....	19
Base value	20
Cable length, Setting.....	15
Cam programming.....	20; 28
Cam programming, Examples	22
Cam search	20
Cam-Bus.....	7
CE.....	2
Commissioning	10
Communication mode.....	7
Cycle time, Setting.....	15
Deactivation point, Moving.....	21
Device search mode	10
DIP switch	7
Display, Type	15
EEPROM, error.....	30
Enable, Input.....	16
Encoder resolution.....	12
Error Reset, Input.....	16
FR output	17
Front view	8
Gear, Electronic	12
General deletion.....	11
Hysteresis, Actual position.....	12
Hystersis, Speed.....	18
I.Err.	30
Initialization, System parameters	11
Inputs	8
Inputs 1 - 4.....	8
Inputs 5 + 6	8
Inputs, Numbers of	16

Keyboard.....	9
Keyboard lock	16
Measuring system control.....	13
millenium.....	2
Multuser	7
O-Err.	30
Offset match for the analog outputs	19
Operation, Outline.....	27
Output display, LED	8
Output selection	20
Output, lock.....	16
Outputs, Numbers of.....	16
Outputs, Speed compensation, Numbers.....	16
PDF - File.....	2
Position display	8
Preset.....	17
Program selection.....	20
Program selection, External.....	16
Programming	11
Programming mode 1, Examples	26
Programming mode, Setup.....	19
Rotation direction output.....	17
Rotation direction, Reversing.....	13
Security output	17
Serial interface	18
SI output.....	17
Speed compensation	20
Speed compensation outputs, Numbers.....	16
Speed compensation programming.....	28
Speed display.....	8
Speed display, Accuracy.....	14
Speed display, Adjustment	14
Speed factor.....	14
Standard	7
Standard display	8
Standstill output	18
Table of contents	3
Technical data.....	33
Troubleshooting	30
Unit configuration, display.....	29
Unit number, Setting	19
Unit number, Setting own.....	7
UP - Date	2
User keys	11
Y2K	2
Zero point, correction.....	14
Zero point; Shifting, External.....	17