



Coaxial Lights

MSU/MFU Series

Ideal for detecting scratches, indentations and dirt on a mirrored work surface

This Collimated-light optical unit is designed for use in inspecting reflective surfaces such as CDs and wafers for small flaws, dents, and dirt.

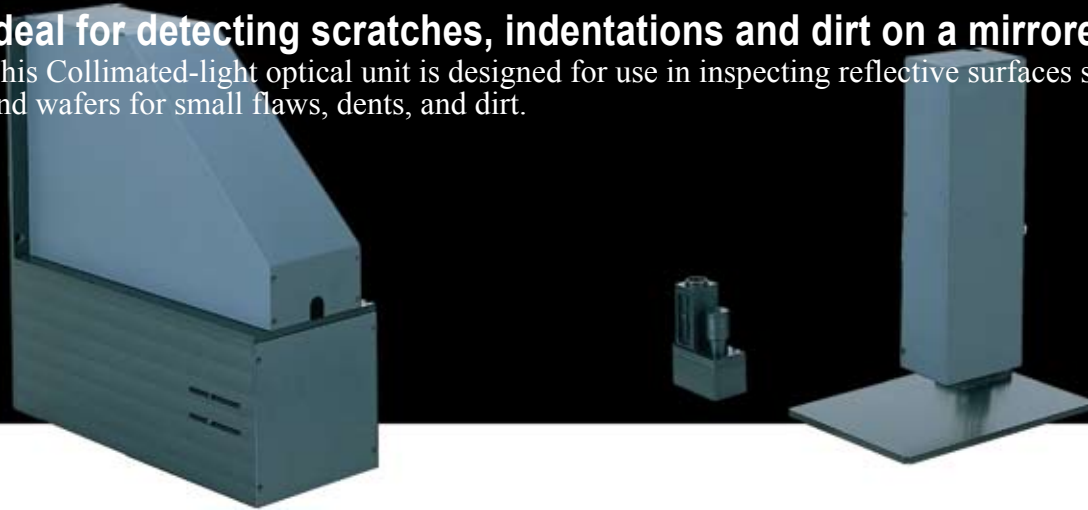

New technology: Collimated-light optical unit

Light emitted from any normal light source propagates in a radial fashion, and disperses as it gets further from the source. Light from a distant source such as the sun (considered to be from an infinite distance) strikes any surface uniformly. The rays are parallel or collimated. The MSU-series Coaxial Light Units have been developed using this principle.

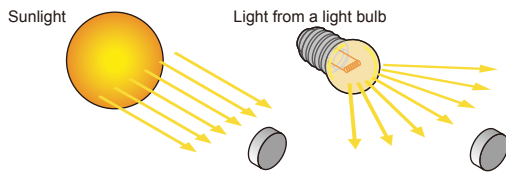

Inspect for flaws, dents, and dirt on reflective surfaces

Using light from a collimated light source is useful for detecting shallow flaws and dents in flat, reflective objects, which were previously difficult to detect. It is also ideal for reading bar codes and laser-engraved characters.

Reading two-dimensional code



The use of LED illumination achieves the triple benefits of high performance, high stability, and low cost. Proving the sophistication of our technology, this ground-breaking product opens up new fields of application for LED lights.

For small, glossy applications (MSU-10)

The MSU Series enables clear imaging of flaws on CD surfaces, engraved characters on lead frames, and 2D code, that were previously difficult to detect using normal coaxial light.



MSU-10 Features

- The camera can be mounted directly onto the C mount at the top of the unit.
- Built-in macro lens allows the field of view to be adjusted from 5 to 15 mm.
- The enclosed focusing adapter allows you to select the optimum light for the workpiece. (Select according to the surface condition and roughness of the workpiece; light intensity is adjustable.)
- A lightweight and compact design enables installation in cramped locations.

Reference of F.O.V.

Camera used: 1/3 CCD camera

Model name	Field of View	WD
MSU-10	7.5mm	58mm
MSU-30	18.7mm	50mm
MSU-30X20	15mm	24mm
MSU-100	60mm	50mm

Note:
The above reference is used as a guide when you select a LED light. The actual data may differ under different imaging conditions or other environment.

Examples of Collimated Light Images

Inspecting for flaws on a lens surface

Flaws and nicks on the lens surface are imaged.

Light used: MSU-10



Inspecting laser characters on a lead frame

The fine laser characters are clearly imaged

Light used: MSU-10



Inspecting for warping and depressions in a CSP

Warped and depressed parts are clearly imaged as black cloudy areas.

Light used: MSU-10

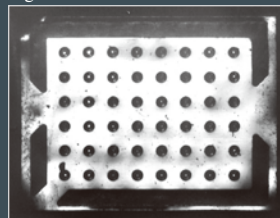

Inspecting laser engraved characters on a wafer

Very finely engraved characters appear with clarity and good contrast.

Light used: MSU-10



Product Lineup Table

Direct Number : You can easily access the web page providing information on any desired product by simply entering the 7-digit direct number in the space provided. (Refer to the back cover of this brochure.)

Series	Direct Number	Model Name	Color	Power Consumption	Option	Dimension
MSU	1002469	MSU-10	●	12V / 0.7W	—	1
	1002471	MSU-10-SW	○			
	1002470	MSU-10-BL	●			
	1002476	MSU-30	●	12V / 0.7W	—	2
	1002477	MSU-30-BL	●			
	1002479	MSU-30×20	●	12V / 0.5W	—	3
	1002485	MSU-30×20-SW	○			
	1002481	MSU-30×20-BL	●			
	1002483	MSU-30×20-GR	●	12V / 0.7W	—	4
	1002472	MSU-100	●			
	1002473	MSU-130	●			
	1002474	MSU-130-CL	○	12V / 0.7W 24V / 4.9W	—	5

Series	Direct Number	Model Name	Color	Power Consumption	Option	Dimension
MFU	1002460	MFU-34×30-BL	●	12V / 0.3W	—	6
	1002462	MFU-54×40-BL	●	12V / 0.3W	—	7

Dimension Diagrams (Unit: mm)

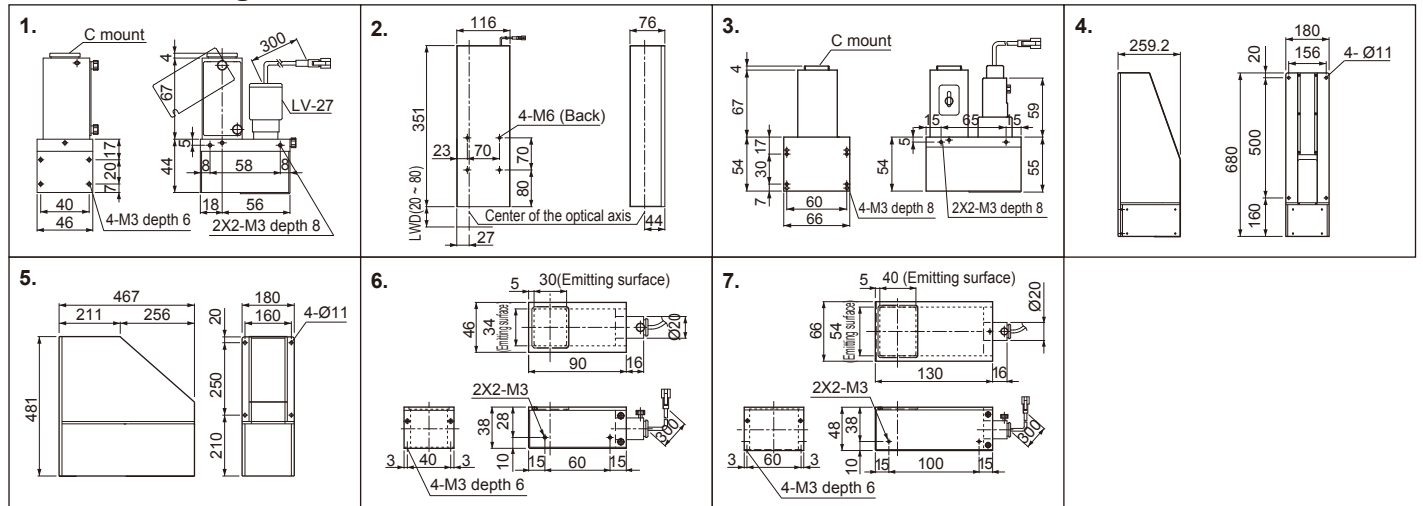

Suppressing stray light reflections for precise appearance inspection and measurement

Using collimated illumination, stray light reflections are suppressed even when the distance between the light source and the object is short, enabling high-precision dimensional measurement. This light method also allows accurate appearance and measurement inspections of glass or other transparent objects without blurring or loss of contrast due to light refraction.

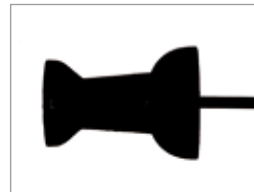

Image Comparisons between the Collimated Backlight and the Diffused Backlight

Light used: LFL-100



Light used: MFU-34X30-BL



Inspecting Pushpin Appearance

When the transparent resin body of the pushpin is backlit using surface illumination from diffused light, the transparent section remains transparent. With collimated illumination, the incident light is refracted from the transparent resin, making the entire surface appear black.

Light used: LFL-100

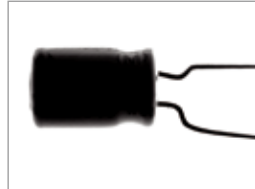

Light used: MFU-34X30-BL

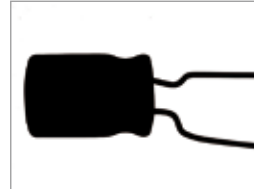

Inspecting Capacitor Appearance and Dimensions

The diffused light of a backlight spreads around the sides of the capacitor body. This light reflection is suppressed with collimated illumination, and even the capacitor leg width is uniformly imaged.

Examples of Collimated Light Images

Inspecting for flaws on a mirrored CD surface

Fine flaws on the surface are brought out clearly and blackly.

Light used: MSU-130



Inspecting the print on a CD surface

A uniformly illuminated image can be captured.

Light used: MSU-130CL



Inspecting for dents in a button battery

The dents are not visible when coaxial light is used

Light used: LFV-70



Even shallow, tiny dents are brought out with parallel light.

Light used: MSU-30x20

