

Price \$5.00

BINMASTER

Taking Control . . . To A Higher Level

PRO REMOTE Series CAPACITANCE PROBE



OPERATING INSTRUCTIONS READ THOROUGHLY BEFORE INSTALLING EQUIPMENT

Distribué par :

HVS

PRECONISATEUR DE SOLUTIONS DEPUIS 1985

2 rue René Laennec 51500 Taissy France
Fax: 03 26 85 19 08, Tel : 03 26 82 49 29

Email : hvssystem@hvssystem.com
Site web : www.hvssystem.com

TABLE OF CONTENTS

GENERAL SPECIFICATIONS	3
1.0 INTRODUCTION	4
2.0 APPLICATIONS	4
3.0 INSTALLATION.....	4
3.1 Location and Mounting	4
3.2 Input Power and Field Wiring	5
3.3 Wiring between Probe Head and Electronic Console	5
4.0 FAIL-SAFE SELECTION	6
4.1 Description	6
4.2 Fail-Safe High.....	6
4.3 Fail-Safe Low	6
5.0 CALIBRATION	7
5.1 Calibration Verification	7
5.2 Calibration Procedure	7
5.3 Sensitivity Selection.....	8
6.0 TIME DELAY	8
7.0 WARRANTY AND CUSTOMER SERVICE	8
7.1 LIMITED WARRANTY8	
7.2 CUSTOMER SERVICE8	
FIGURE 1.1	9
FIGURE 1.2	10
FIGURE 1.3	11
FIGURE 1.4	12
FIGURE 1.5	13
FIGURE 2.1	14



Taking Control... To A Higher Level

PRO REMOTE GENERAL SPECIFICATIONS

Supply:	120/240 VAC 50/60 Hz
Supply Tolerance:	-15% +10%
Load:	5VA
Ambient Temperature: (Electronics)	-40° F to +185° F (-40° C to +85° C)
Sensitivity:	1 picofarad
Enclosure:	Type 4X, 5, 12
Relay Output:	DPDT contacts; 10 Amps 250 VAC STATUS contacts; 3 Amps 240VAC
Fail-Safe:	Switch selectable "High" or "Low" level modes
Calibration:	Set when probe is uncovered: COARSE adjust; single turn potentiometer FINE adjust; single turn potentiometer
Status Indicator:	Internal LED indicates material in contact with probe. STATUS relay includes the time delay setting: Flashing -- Probe uncovered ON Solid -- Probe covered OFF -- Power failure
Time Delay:	Adjustable from 1 to 10 seconds
Probe Shield:	Automatically compensates for material buildup on the probe
Conduit Entry:	3/4" NPT

1.0 INTRODUCTION

The Bin-Master PRO REMOTE is a point level control used to detect the presence or absence of liquids or granular solids. The PRO REMOTE operates on the capacitance principle and incorporates a "Quick Set" feature to simplify calibration. The PRO REMOTE includes switch selectable Fail-Safe output contacts and "Probe Shield" technology for ignoring material build-up.

Upon installation the PRO REMOTE is set up with the probe uncovered. The "Quick Set" feature allows simple setup and calibration of the unit to achieve low, medium, or high sensitivity settings. The PRO REMOTE has an adjustable time delay of relay output for covered or uncovered conditions and a STATUS OUTPUT for monitoring power to the unit as well as covered and uncovered conditions.

2.0 APPLICATIONS

2.1 The PRO REMOTE electronics is available in two versions based on the length of cable between the electronics and the remote probe. One version is for cable lengths of 7 to 35 feet and the other version for cable lengths of 20 to 75 feet. The length of cable effects the stability of calibration and in all applications the cable length should be kept as short as is practical within the stated ranges. Long cable lengths should not be used where high sensitivity is required.

2.2 For applications in pressurized vessels up to 1500 PSI, the PRO REMOTE should be mounted with the 3/4" stainless steel coupling.

2.3 Application temperatures for the various probes are:

- | | |
|------------------------------------|------------|
| 1. Delrin Sleeved Stainless Steel: | 250 Deg. F |
| 2. Teflon Sleeved Stainless Steel: | 500 Deg. F |
| 3. Flush Mount (Polyethylene): | 180 Deg. F |
| 4. Flush Mount (Teflon): | 450 Deg. F |

3.0 INSTALLATION

3.1 Location and Mounting

The PRO REMOTE PROBE HEAD is designed to mount utilizing either a standard 1- 1/4" NPT coupling or optional 3/4" NPT coupling. When the PROBE HEAD is used with the flush mount probe, the flush mount probe mounts directly to the vessel wall using a 7" diameter bolt circle. Refer to Figures 1.1 through 1.4 for illustrations on installation, mounting options, and different probe combinations.

The PROBE HEAD should be mounted in a position such that the probe itself is not in the direct flow of material.

The vessel on which the PRO REMOTE PROBE HEAD is mounted must be made of metal which acts as part of the capacitive environment. If the vessel is not metal, a suitable metal plate must be installed with the Remote Probe Head.

3.2 Input Power and Field Wiring

The PRO REMOTE can be powered from either a 120 VAC or 240 VAC 50/60 Hz supply (see diagram below). Field wiring should conform to all national and local electrical codes and any other agency or authority having jurisdiction over the installation.

120 VAC SUPPLY

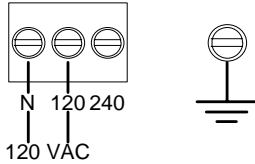

240 VAC SUPPLY

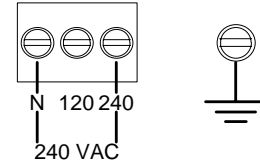

3.3 Wiring between Probe Head and Electronic Console

The remote probe is connected to the electronics with Belden 88232 triaxial cable. The ends of the cable should be prepared as shown below. Prepare the cable as shown below. Connect each shield and the center conductor to the appropriate terminal as shown in Figure 1.5. Be sure that there are no loose strands that could short to another terminal or conductor.

NOTE: Place the cable strain relief nut and rubber grommet on the triax cable before preparing the ends of the cable.

Strip the outer teflon jacket off 1 3/4 inches away from the end of the cable. Unbraid the strands of the outer shield and then twist them together. Strip the inner teflon jacket off 1 1/2 inches away from the end of the cable. Unbraid the strands of the inner shield and then twist them together. Cut both shields so that they are 3/4 inch long. Strip 1/2 inch of the insulation off of the inner conductor. Each shield and the center conductor should be spaced 3/8 inch apart as shown.

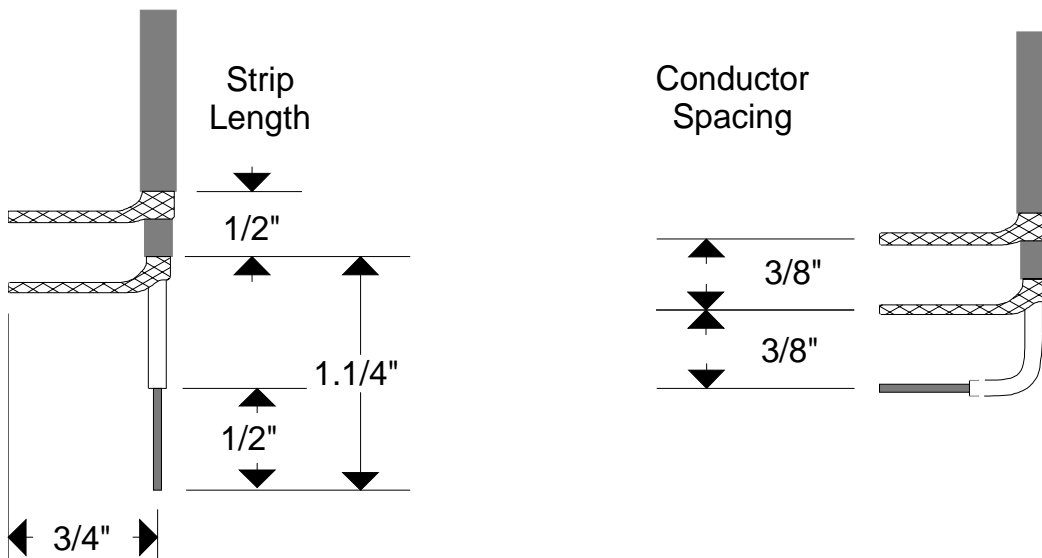

4.0 FAIL-SAFE SELECTION

4.1 Description

A Fail-Safe condition means that the relay contact positions are set up so that in the event of a power failure, the relay will be de-energized and the contacts will indicate a condition that is deemed safe for the application. (Refer to FIGURE 2.1 for the location of the Fail-Safe selection switch.)

4.2 Fail-Safe High

Fail-Safe High means that the relay will be energized when the probe is uncovered and will de-energize when the probe is covered. In this mode, a power failure will cause the relay contacts to indicate that the probe is covered whether it is or not.

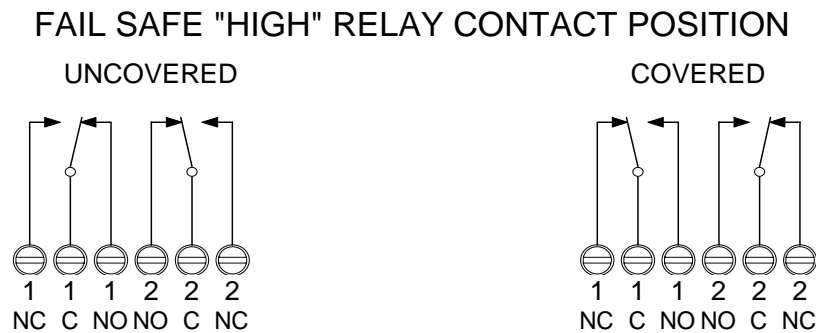

4.3 Fail-Safe Low

Fail-Safe Low means that the relay will be de-energized when the probe is uncovered and will energize when the probe is covered. In this mode, a power failure will cause the relay contacts to indicate that the probe is uncovered whether it is or not.

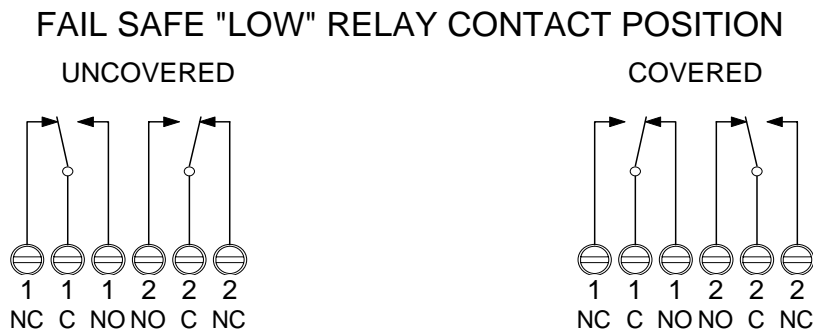

5.0 CALIBRATION

The PRO REMOTE Quick Set calibration feature uses two single turn potentiometers making calibration very simple. One potentiometer labeled COARSE is used to compensate for the capacitance of the empty vessel. The other potentiometer labeled FINE is used to set in the desired sensitivity. Refer to FIGURE 2.1 for the location of these potentiometers on the printed circuit board. A tool for adjusting the COARSE and FINE potentiometers is provided inside the electronics enclosure of the PRO REMOTE. A convenient clip for storing the tool is provided in the enclosure.

The characteristics of the cable between the electronics and probe head are affected by temperature. The PRO REMOTE uses high quality Teflon cable to minimize these effects and provide maximum stability of calibration. For best results, the cable and electronics should be at normal operating temperature when calibration is performed. Apply power to electronics for at least 15 minutes before calibrating.

NOTE 1 : Accurate calibration requires that the appropriate probe be attached to the PRO REMOTE PROBE HEAD and the unit installed in the vessel. The probe must be UNCOVERED and material well below it.

NOTE 2 : FLUSH PROBE : Use of the FLUSH PROBE with long cable lengths may require resetting the factory set potentiometer R13. This will be required if the COVERED indicator does not turn OFF when both the COARSE and FINE adjustments are full counter-clockwise, CCW. If this is the case, remove the black vinyl cover from R13. This may be pulled off with the fingers. Set the COARSE adjustment to the 9 O'Clock position and the FINE adjustment fully CCW. Now slowly turn R13 clockwise CW to the point where the COVERED indicator just turns OFF. Replace the black cover on R13. The unit can now be calibrated using the standard procedure of paragraph 5.2.

5.1 Calibration Verification

Following calibration adjustment, the sensitivity setting that you have selected should be checked by verifying that the PRO REMOTE senses a covered probe condition with your material.

5.2 Calibration Procedure

1. Turn both the COARSE and FINE potentiometers fully counter clockwise (CCW). The internal COVERED indicator light should be OFF.
2. Turn the COARSE potentiometer slowly clockwise (CW) to the point where the COVERED indicator light just turns ON and stays on.
3. Turn the FINE potentiometer slowly clockwise (CW) until the COVERED indicator light just turns OFF. (If the COARSE potentiometer has been carefully adjusted, this should occur when the FINE potentiometer is between the 8 and 11 O'clock position.) Now continue to turn the FINE potentiometer clockwise (CW) to the desired sensitivity setting.

HIGH sensitivity:	1/16 to 1/8 turn (1 to 3 picofarad)
MEDIUM sensitivity:	1/8 to 1/4 turn (3 to 6 picofarad)
LOW sensitivity:	1/4 to 1/2 turn (6 to 12 picofarad)

5.3 Sensitivity Selection

Sensitivity Setting (typical)	Dielectric Constant of Material
HIGH sensitivity:	4 or less
MEDIUM sensitivity:	4 to 10
LOW sensitivity:	10 or higher

6.0 TIME DELAY

The PRO REMOTE has an adjustable time delay up to 10 seconds. This is a time delay for the output to change states from an uncovered to a covered condition and from a covered to an uncovered condition. This time delay affects the DPDT and STATUS relay contacts. The internal LED (DS1) will immediately respond to a change in covered or uncovered condition regardless of the time delay setting.

Minimum time delay is when the DELAY potentiometer is set fully counter-clockwise. (Refer to FIGURE 2.1 for the location of the DELAY potentiometer.) Maximum time delay is with the DELAY potentiometer set fully clockwise.

A tool for adjusting the TIME DELAY potentiometer is provided inside the electronics enclosure of the PRO REMOTE. A convenient clip for storing the tool is provided in the enclosure.

7.0 WARRANTY AND CUSTOMER SERVICE

7.1 Limited Warranty

The manufacturer warrants this equipment for two (2) years according to the following terms:

- 1.) This warranty extends to the original purchaser only and commences on the date of original purchase. The original purchaser must mail to the manufacturer the "Warranty Registration" card to confirm the equipment purchase. Failure to do so may void the warranty.
- 2.) The manufacturer will repair or replace any part of this equipment found to be defective, provided such part is delivered prepaid, to the factory. Manufacturer's obligation is limited to the cost of material and labor to repair or replace and does not include transportation expenses.
- 3.) This warranty shall not apply to any product which has, in our judgment, been tampered with, altered, subject to misuse, neglect or accident. In addition, the warranty does not extend to repairs made necessary by normal wear .
- 4.) This warranty is in lieu of all other warranties, expressed or implied.

7.2 Customer Service

Bin Master offers a toll-free Customer Service phone number 1-800-278-4241. You may call the Customer Service Department for technical and application assistance Monday through Friday from 8:00AM to 5:00PM Central Time. International customers call us at (402) 434-9102 or reach us via fax at (402) 434-9133.

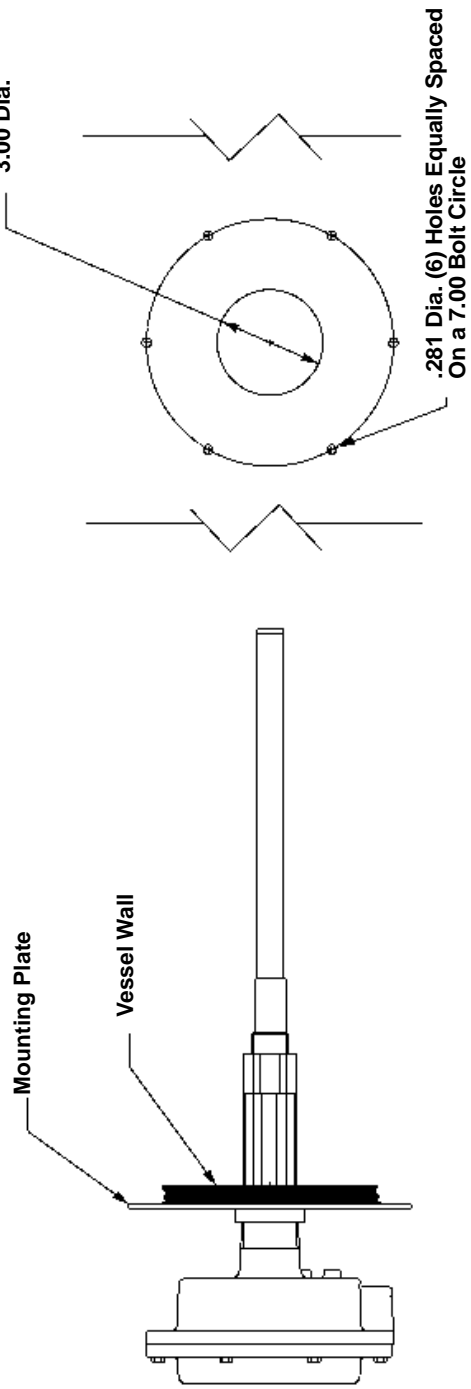

Standard Mounting Plate

Mounting Hole Pattern
In Vessel Wall

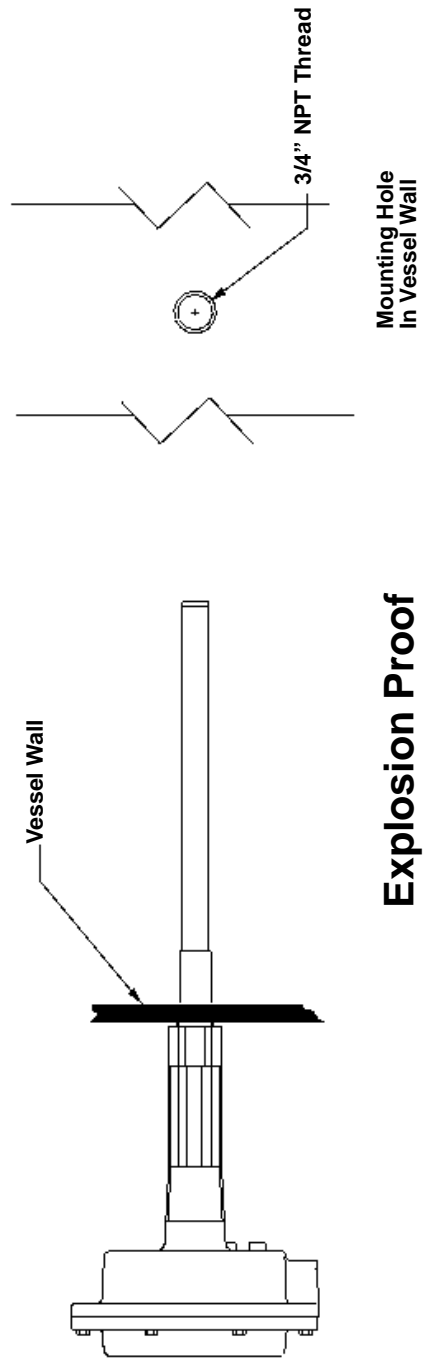

Explosion Proof High Pressure Coupling

9270061.dgn
927a061.tif

Figure 1.1

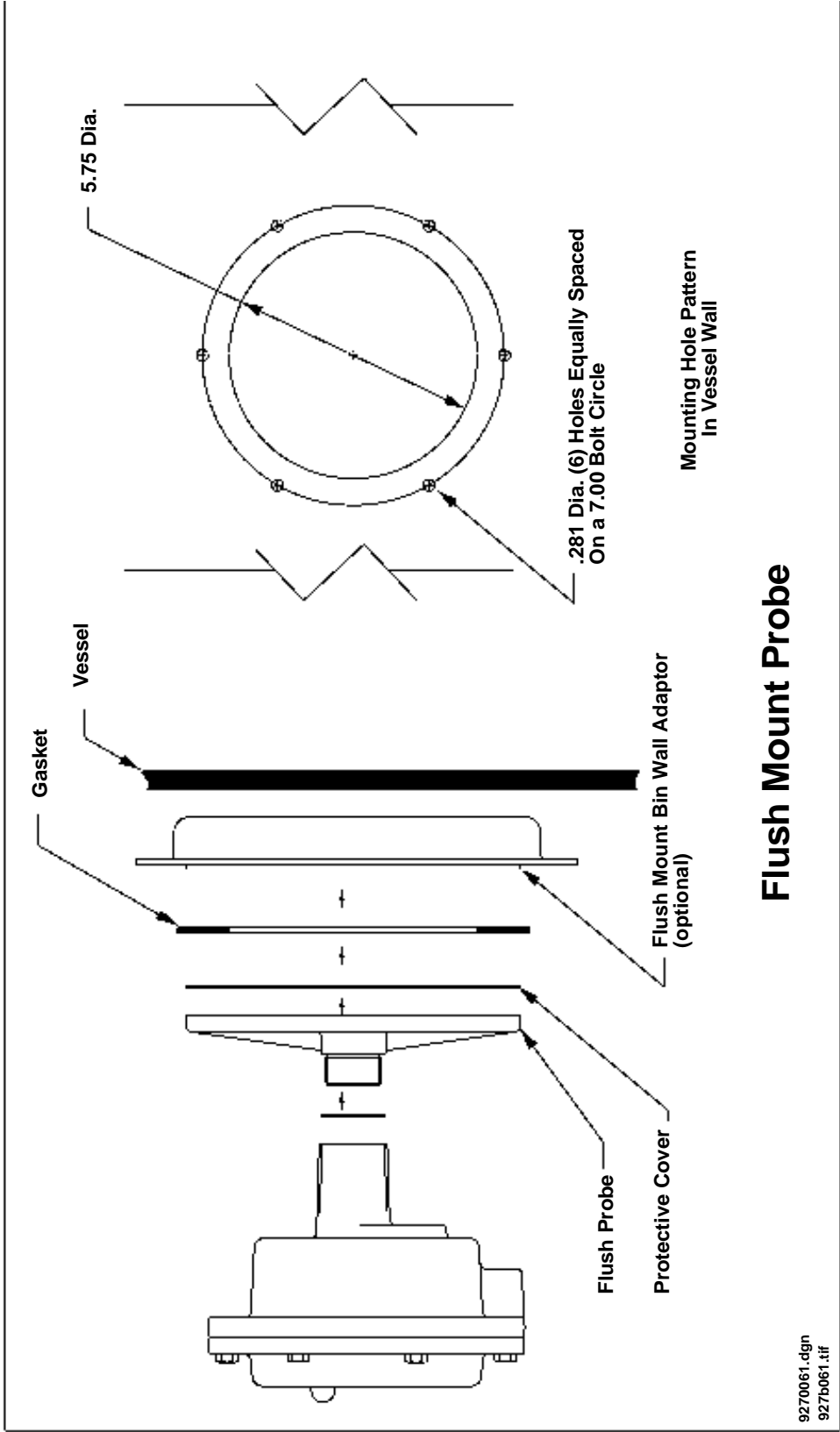

9270061.dgn
927b061.tif

Flush Mount Probe

Figure 1.2

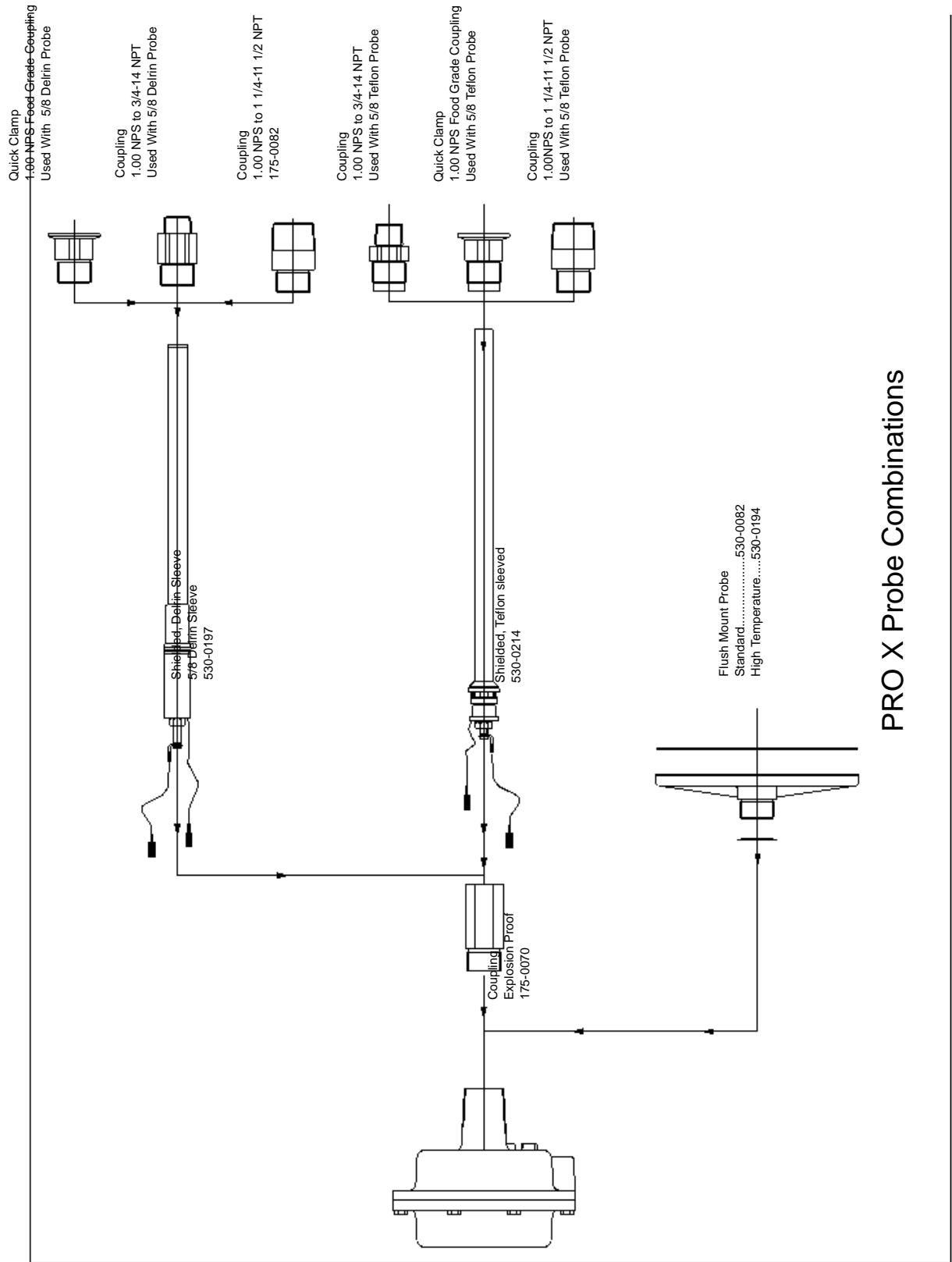

PRO X Probe Combinations

Figure 1.3

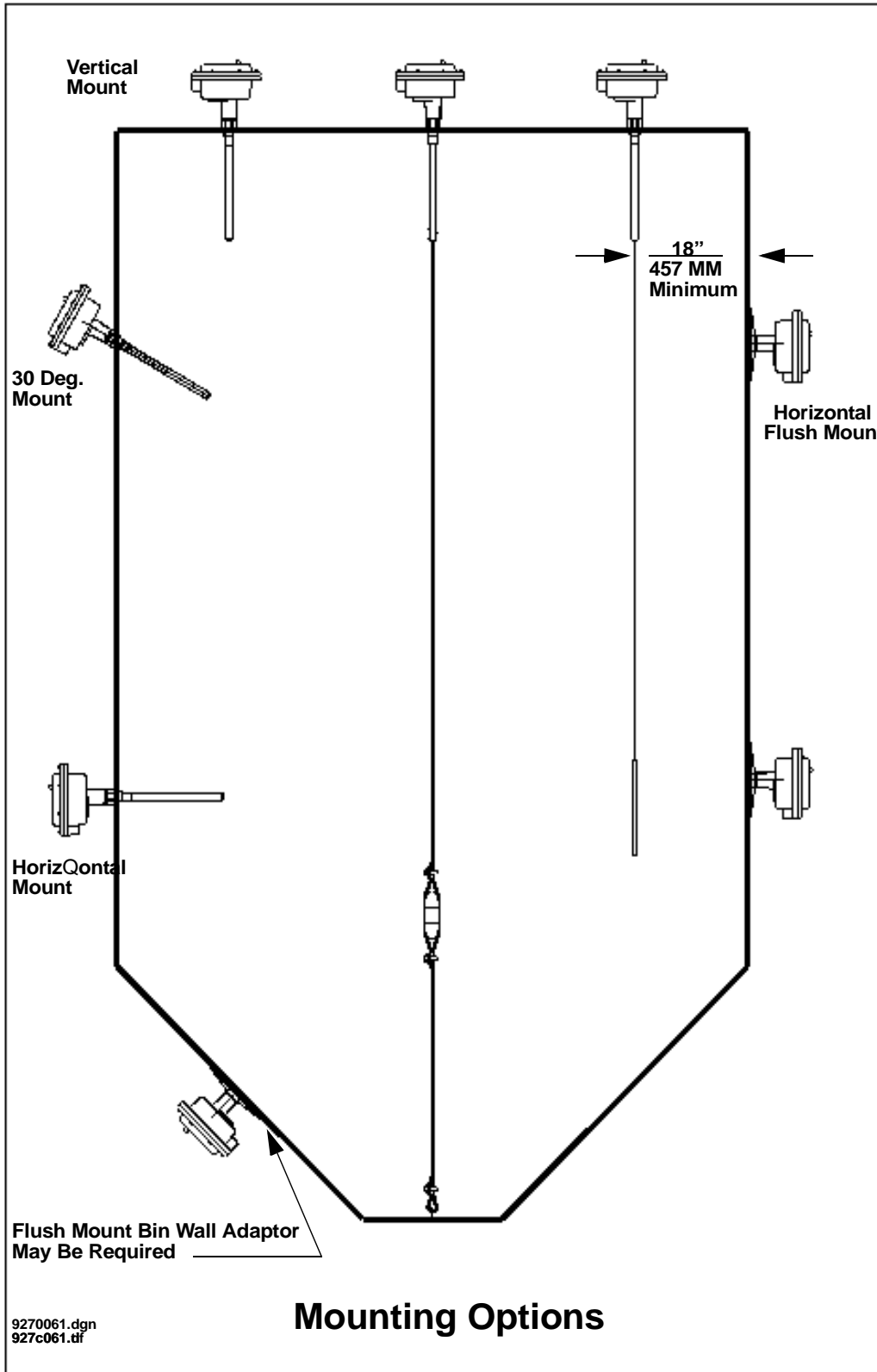

Figure 1.4

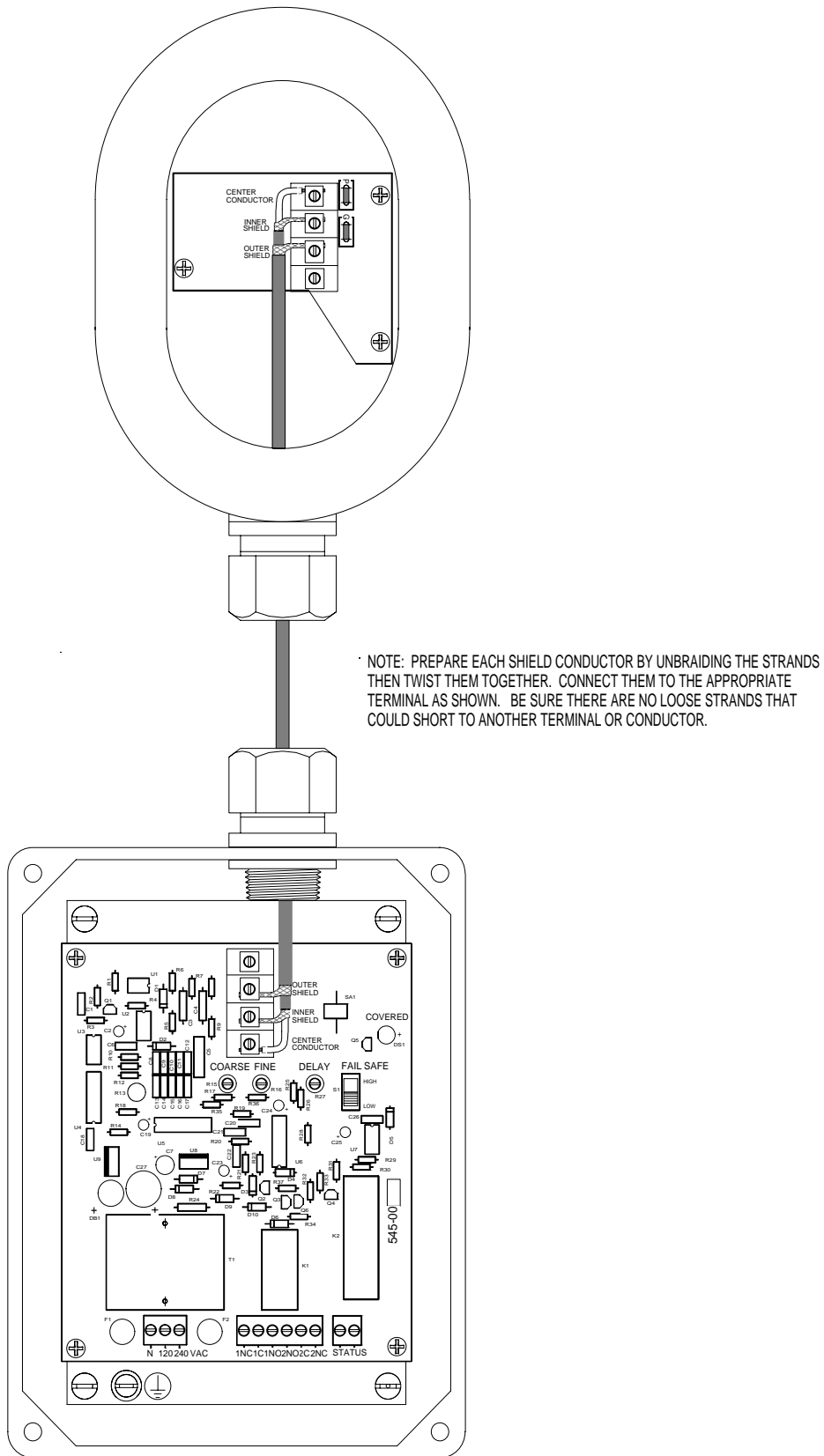

Figure 1.5

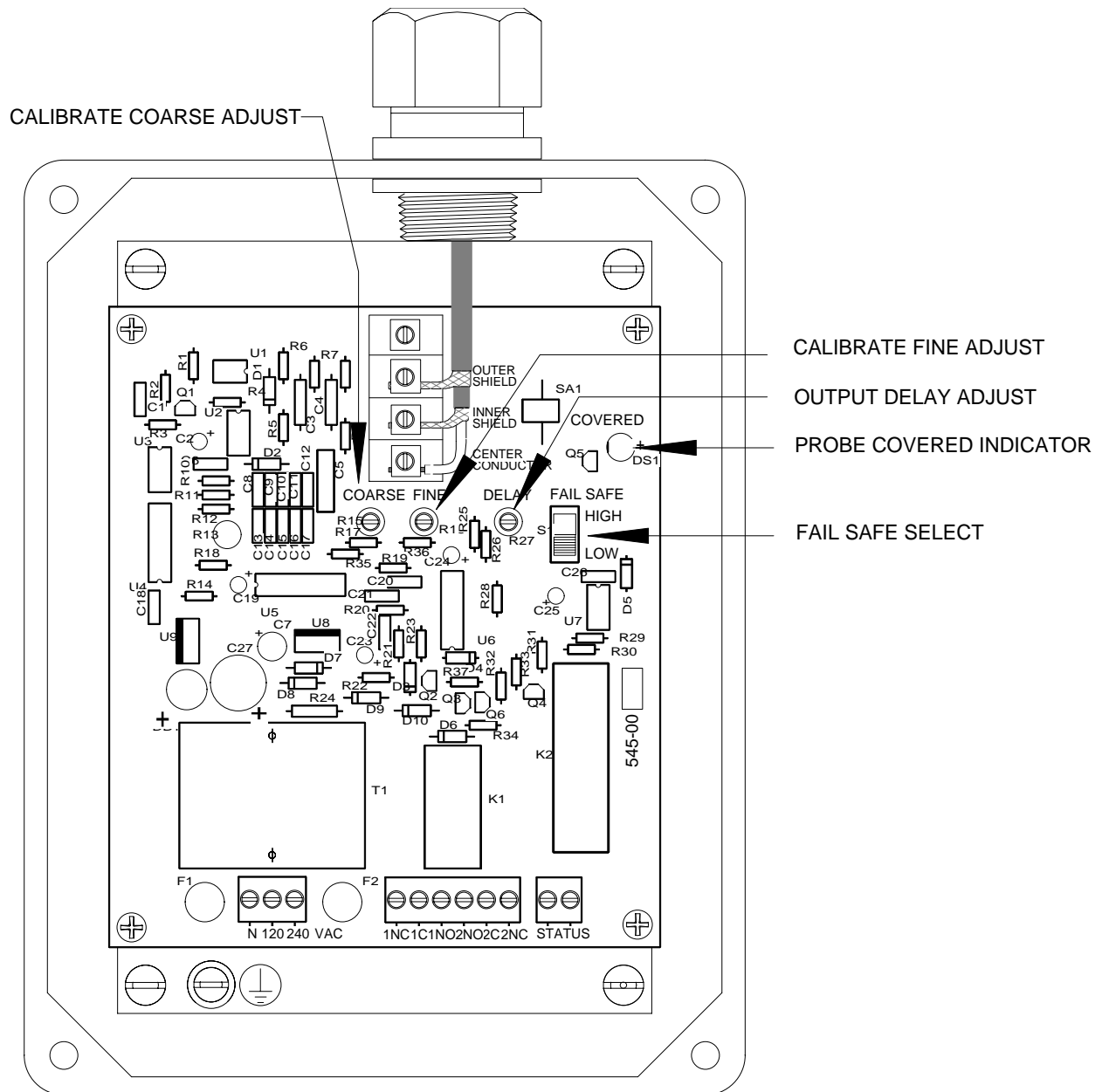
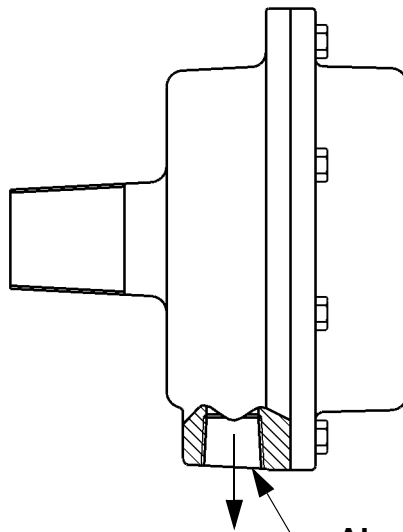
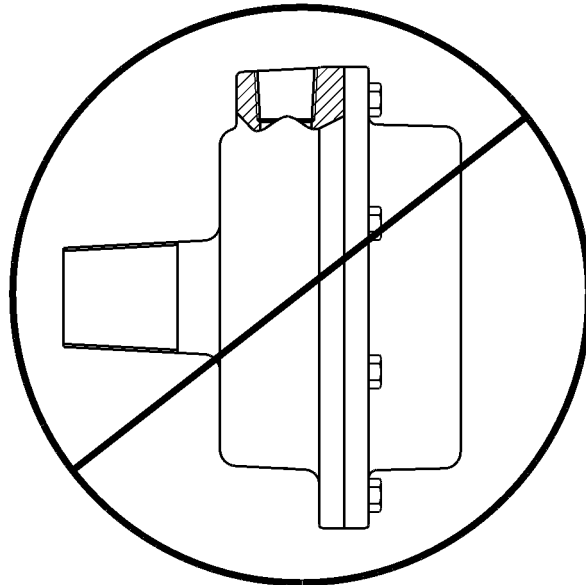

Figure 2.1

Mounting Instructions



Always Mount Unit with Conduit Opening Down



CONDUIT SEAL

When installing this level indicator in environments where it is possible for moisture or moist air to enter the enclosure thru the electrical conduit, the conduit opening should be sealed with a duct seal compound or putty appropriate for the purpose.

Distribué par :



2 rue René Laennec 51500 Taissy France
Fax: 03 26 85 19 08, Tel : 03 26 82 49 29

Email : hvssystem@hvssystem.com
Site web : www.hvssystem.com